

# Turmdrehkran

Tower Crane / Grue à tour / Gru a torre / Grúa torre  
Guindaste de torre / Башенный поворотный кран

# 110 EC-B 6 FR.tronic®

**110 EC-B 6**

▶ **110 EC-B 6 FR.tronic®**

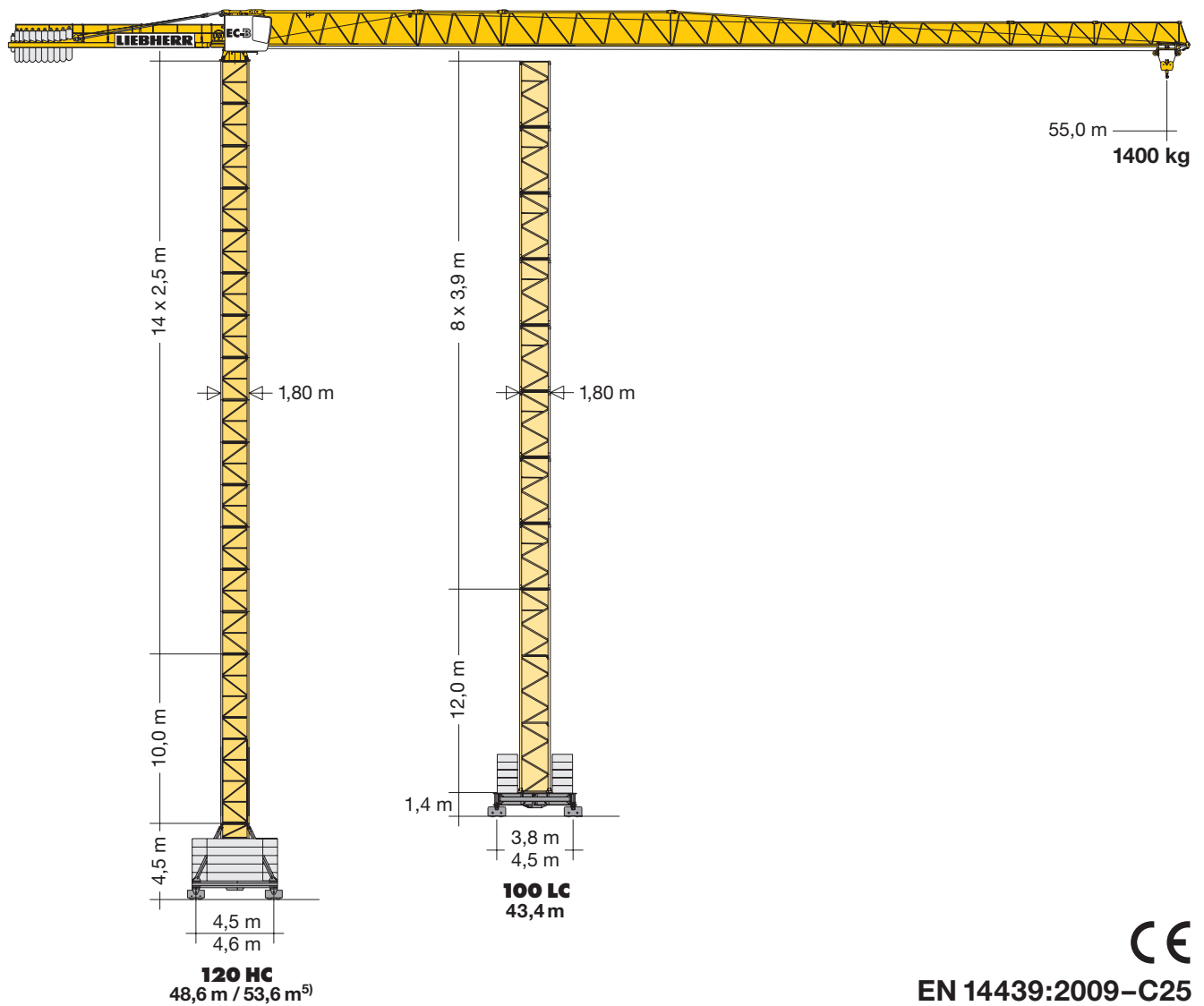

# LIEBHERR

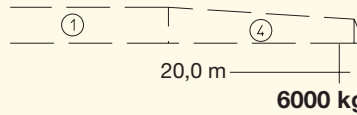
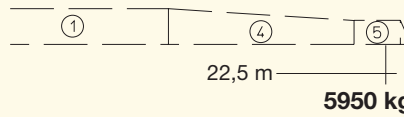
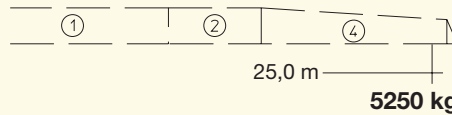
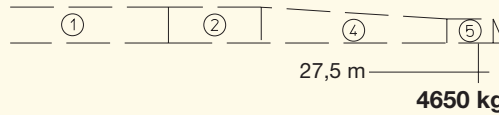
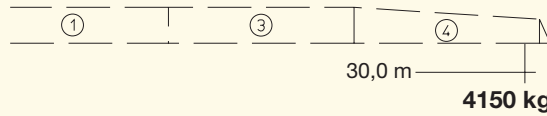
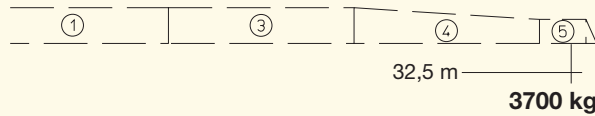
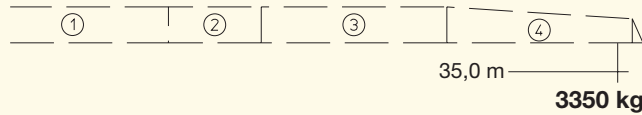
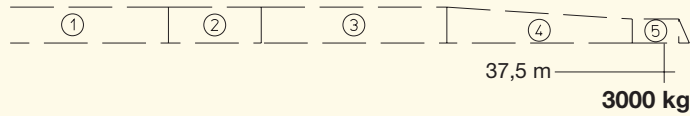
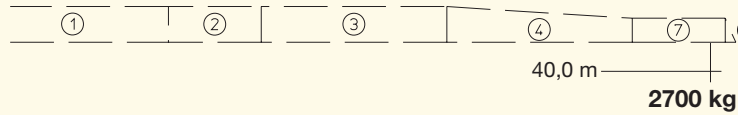
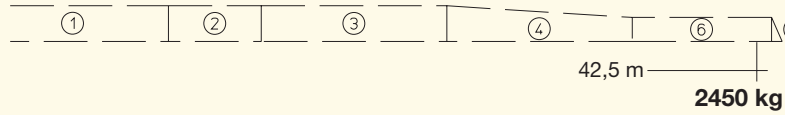
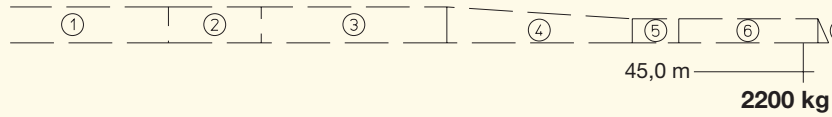
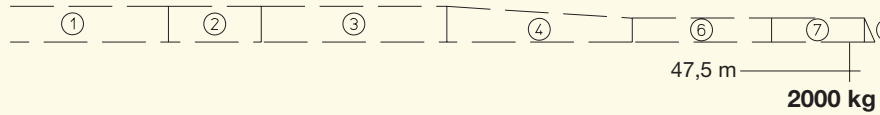
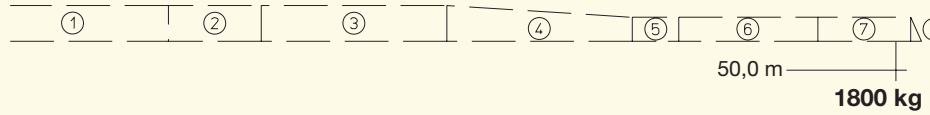
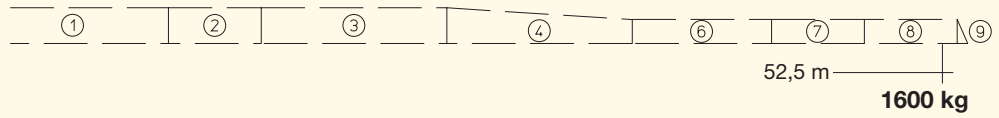
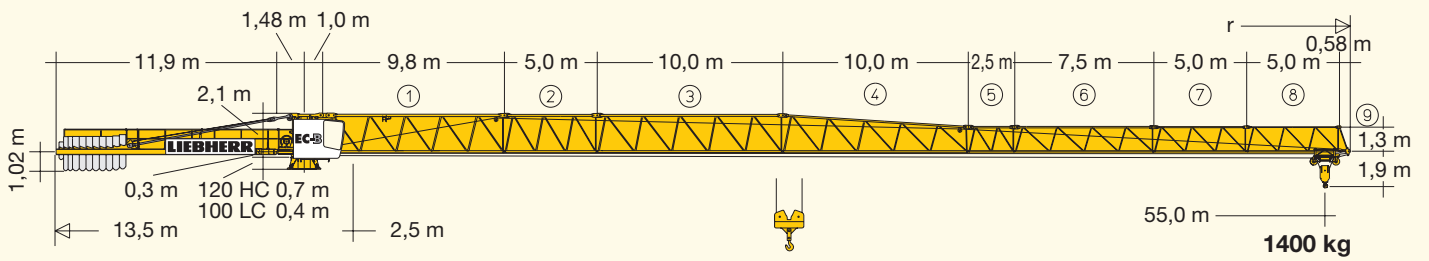

## 110 EC-B 6 FR.tronic®

m	r	m/kg	m/kg															
			17,5	20,0	22,5	25,0	27,5	30,0	32,5	35,0	37,5	40,0	42,5	45,0	47,5	50,0	52,5	55,0
55,0	(r = 56,5)	2,5-17,0 6000	5800	5000	4370	3870	3460	3120	2830	2580	2360	2170	2010	1860	1730	1610	1500	1400
52,5	(r = 54,0)	2,5-17,8 6000	6000	5270	4610	4080	3650	3290	2990	2730	2500	2310	2130	1980	1840	1710	1600	
50,0	(r = 51,5)	2,5-18,4 6000	6000	5480	4800	4260	3810	3440	3120	2850	2620	2420	2230	2070	1930	1800		
47,5	(r = 49,0)	2,5-18,9 6000	6000	5650	4950	4390	3930	3550	3230	2950	2710	2500	2310	2150	2000			
45,0	(r = 46,5)	2,5-19,3 6000	6000	5770	5050	4480	4020	3630	3300	3020	2770	2560	2370	2200				
42,5	(r = 44,0)	2,5-19,8 6000	6000	5940	5210	4620	4140	3740	3410	3120	2860	2640	2450					
40,0	(r = 41,5)	2,5-20,2 6000	6000	6000	5310	4710	4230	3820	3470	3180	2920	2700						
37,5	(r = 39,0)	2,5-20,6 6000	6000	6000	5440	4830	4330	3910	3560	3260	3000							
35,0	(r = 36,5)	2,5-21,1 6000	6000	6000	5570	4950	4440	4020	3660	3350								
32,5	(r = 34,0)	2,5-21,3 6000	6000	6000	5630	5010	4490	4060	3700									
30,0	(r = 31,5)	2,5-21,7 6000	6000	6000	5750	5110	4590	4150										
27,5	(r = 29,0)	2,5-21,9 6000	6000	6000	5830	5180	4650											
25,0	(r = 26,5)	2,5-22,2 6000	6000	6000	5910	5250												
22,5	(r = 24,0)	2,5-22,3 6000	6000	6000	5950													
20,0	(r = 21,5)	2,5-20,0 6000	6000	6000														

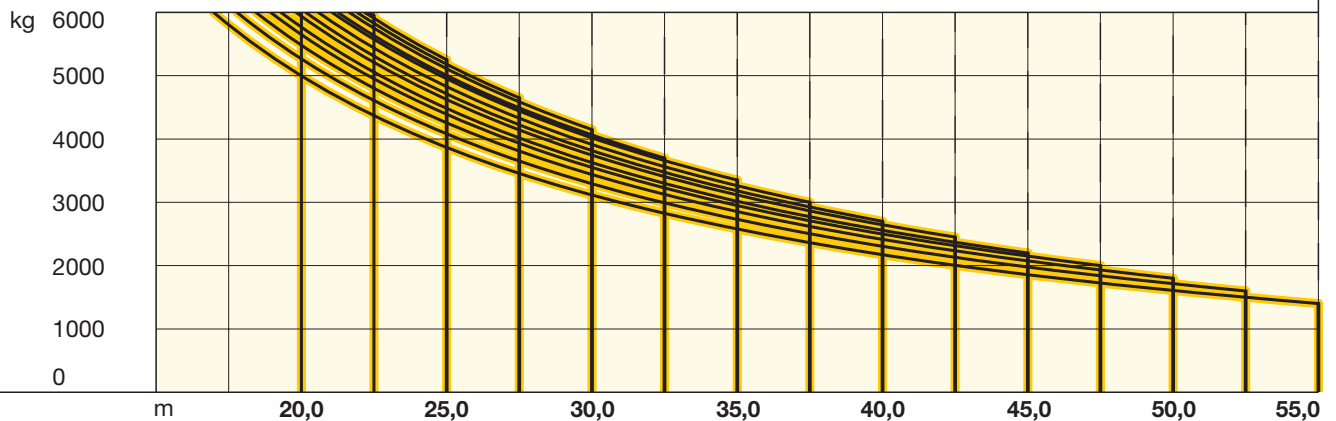

3,9m		5,85m		11,7m		100 LC											
3,9m	5,85m	5,85m	11,7m	C 25		a)		b)		a)		b)		a)		b)	
11	-	-	-	-	-	43,7	-	-	43,8	-	-	43,1	-	-	42,0	-	-
10	9+1	7	-	-	-	41,8	-	-	41,9	-	-	41,2	-	-	40,0	-	-
9	8+1	6	3	-	-	39,8	51,4 <sup>o</sup>	51,4	39,9	51,5 <sup>o</sup>	51,5	39,2	50,8 <sup>o</sup>	50,8	38,1	50,0	-
8	7+1	5	-	-	-	37,9	49,5	49,5	38,0	49,6	49,6	37,3	48,9	48,9	36,1	48,1	-
7	6+1	4	2	-	-	35,9	47,5	47,5	36,0	47,6	47,6	35,3	46,9	46,9	34,2	46,1	-
6	5+1	3	-	33,8	33,8	34,0	45,6	45,6	34,1	45,7	45,7	33,4	45,0	45,0	32,2	44,2	-
5	4+1	2	-	31,8	31,8	32,0	43,6	43,6	32,1	43,7	43,7	31,4	43,0	43,0	30,3	42,2	-
4	3+1	1	-	29,9	29,9	30,1	41,7	41,7	30,2	41,8	41,8	29,5	41,1	41,1	28,3	40,3	-
3	2+1	0	-	27,9	27,9	28,1	39,7	39,7	28,2	39,8	39,8	27,5	39,1	39,1	26,4	38,3	-
2	1+1	0	-	26,0	26,0	26,2	37,8	37,8	26,3	37,9	37,9	25,6	37,2	37,2	24,4	36,4	-
1	0+1	0	-	24,0	24,0	24,2	35,8	35,8	24,3	35,9	35,9	23,6	35,2	35,2	22,5	34,4	-
0	0	0	-	22,1	22,1	22,3	33,9	33,9	22,4	34,0	34,0	21,7	33,3	33,3	20,5	32,5	-
				20,1	20,1	20,3	31,9	31,9	20,4	32,0	32,0	19,7	31,3	31,3	18,6	30,5	-
				18,2	18,2	18,4	30,0	30,0	18,5	30,1	30,1	17,8	29,4	29,4	16,6	28,6	-
				16,2	16,2	16,4	28,0	28,0	16,5	28,1	28,1	15,8	27,4	27,4	14,7	26,6	-
				14,3	14,3	14,5	26,1	26,1	14,6	26,2	26,2	13,9	25,5	25,5	12,7	24,7	-
				12,3	12,3	12,5	24,1	24,1	12,6	24,2	24,2	11,9	23,5	23,5	10,8	22,7	-
				10,4	10,4	10,6	22,2	22,2	10,7	22,3	22,3	10,0	21,6	21,6	8,8	20,8	-
				8,4	8,4	8,6	20,2	20,2	8,7	20,3	20,3	8,0	19,6	19,6	6,9	18,8	-
				6,5	6,5	6,7	18,3	18,3	6,8	18,4	18,4	6,1	17,7	17,7	4,9	16,9	-
				4,5	4,5	4,7	16,3	16,3	4,8	16,4	16,4	4,1	15,7	15,7	3,0	14,9	-
				-	-	-	12,4	12,4	-	12,5	12,5	-	11,8	11,8	-	11,0	-

o = Ohne Kabine / Without cabin / Sans cabine / Senza cabina / Sin cabina / Sem cabine / Без кабины

Weitere Hubhöhen sowie Klettern auf Anfrage. / Further hoist heights and climbing on request. / Hauteurs sous crochet plus élevées et hissage sur demande. / Altre altezze di sollevamento come pure telescopaggio, su richiesta. / Para alturas bajo gancho superiores y trepado, consultar. Outras alturas de elevação e ascensionamento, mediante consulta. / Другие высоты подъема и наращивание крана – по запросу.

C 25		120 HC															
17	-	-	-	-	48,7 <sup>3)</sup>	-	-	-	-	-	-	-	-	-	-	-	-
16	50,5 <sup>3)</sup>	53,6 <sup>5)</sup>	50,0 <sup>3)</sup>	53,1 <sup>5)</sup>	46,2 <sup>2)</sup>	49,3 <sup>2)</sup>	-	-	47,7 <sup>4)</sup>	-	47,5 <sup>2)</sup>	50,6 <sup>3)</sup>	47,5 <sup>2)</sup>	50,6 <sup>3)</sup>	47,5 <sup>2)</sup>	50,6 <sup>3)</sup>	-
15	48,0 <sup>2)</sup>	51,1 <sup>3)</sup>	47,5 <sup>2)</sup>	50,6 <sup>3)</sup>	43,7 <sup>2)</sup>	46,8 <sup>2)</sup>	45,2 <sup>4)</sup>	-	45,2 <sup>2)</sup>	48,3 <sup>4)</sup>	45,0 <sup>2)</sup>	48,1 <sup>2)</sup>	45,0 <sup>2)</sup>	48,1 <sup>2)</sup>	45,0 <sup>2)</sup>	48,1 <sup>2)</sup>	-
14	45,5 <sup>2)</sup>	48,6 <sup>2)</sup>	45,0 <sup>2)</sup>	48,1 <sup>2)</sup>	41,2 <sup>2)</sup>	44,3 <sup>2)</sup>	42,7 <sup>2)</sup>	45,8 <sup>2)</sup>	42,7 <sup>2)</sup>	45,8 <sup>2)</sup>	42,5 <sup>2)</sup>	45,6 <sup>2)</sup>	42,5 <sup>2)</sup>	45,6 <sup>2)</sup>	42,5 <sup>2)</sup>	45,6 <sup>2)</sup>	-
13	43,0 <sup>2)</sup>	46,1 <sup>2)</sup>	42,5 <sup>2)</sup>	45,6 <sup>2)</sup>	38,7	41,8	40,2 <sup>2)</sup>	43,3 <sup>2)</sup>	40,2 <sup>2)</sup>	43,3 <sup>2)</sup>	40,0	43,1 <sup>2)</sup>	40,0	43,1 <sup>2)</sup>	40,0	43,1 <sup>2)</sup>	-
12	40,5	43,6 <sup>2)</sup>	40,0	43,1 <sup>2)</sup>	36,2	39,3	37,7	40,8 <sup>2)</sup>	37,7	40,8 <sup>2)</sup>	37,5	40,6	37,5	40,6	37,5	40,6	-
11	38,0	41,1	37,5	40,6	33,7	36,8	35,2	38,3	35,2	38,3 <sup>2)</sup>	35,0	38,1	35,0	38,1	35,0	38,1	-
10	35,5	38,6	35,0	38,1	31,2	34,3	32,7	35,8	32,7	35,8	32,5	35,6	32,5	35,6	32,5	35,6	-
9	33,0	36,1	32,5	35,6	28,7	31,8	30,2	33,3	30,2	33,3	30,0	33,1	30,0	33,1	30,0	33,1	-
8	30,5	33,6	30,0	33,1	26,2	29,3	27,7	30,8	27,7	30,8	27,5	30,6	27,5	30,6	27,5	30,6	-
7	28,0	31,1	27,5	30,6	23,7	26,8	25,2	28,3	25,2	28,3	25,0	28,1	25,0	28,1	25,0	28,1	-
6	25,5	28,6	25,0	28,1	21,2	24,3	22,7	25,8	22,7	25,8	22,5	25,6	22,5	25,6	22,5	25,6	-
5	23,0	26,1	22,5	25,6	18,7	21,8	20,2	23,3	20,2	23,3	20,0	23,1	20,0	23,1	20,0	23,1	-
4	20,5	23,6	20,0	23,1	16,2	19,3	17,7	20,8	17,7	20,8	17,5	20,6	17,5	20,6	17,5	20,6	-
3	18,0	21,1	17,5	20,6	13,7	16,8	15,2	18,3	15,2	18,3	15,0	18,1	15,0	18,1	15,0	18,1	-
2	15,5	18,6	15,0	18,1	11,2	14,3	12,7	15,8	12,7	15,8	12,5	15,6	12,5	15,6	12,5	15,6	-
1	13,0	16,1	12,5	15,6	8,7	11,8	10,2	13,3	10,2	13,3	10,0	13,1	10,0	13,1	10,0	13,1	-
0	10,5	13,6	10,0	13,1	6,2	9,3	7,7	10,8	7,7	10,8	7,5	10,6	7,5	10,6	7,5	10,6	-

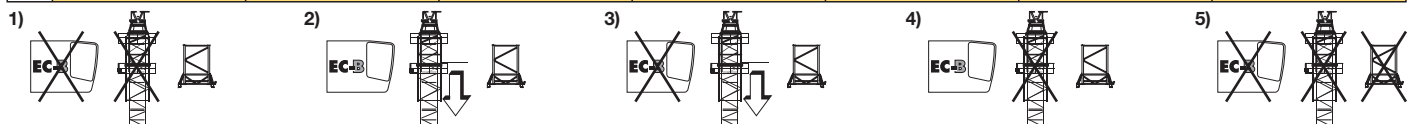

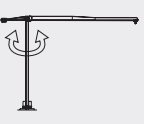
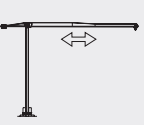
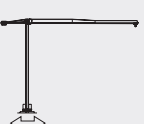
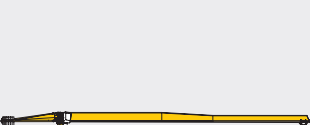

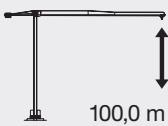
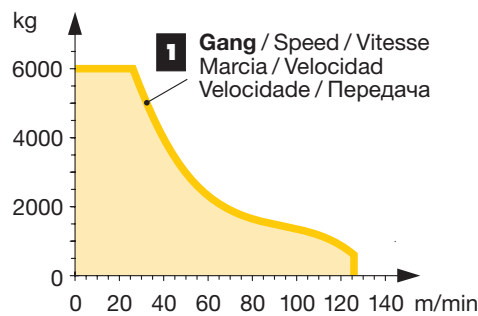











	U/min 0 ↔ 0,8 sl./min tr./min	7,5 kW FU
	0 ↔ 63,0 m/min 0 ↔ 80,0 m/min	3,0 kW FU 5,4 kW FU
	25,0 m/min	2 x 4,0 kW
	<b>kVA</b>	30 kW FU 33,0



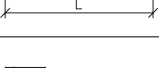

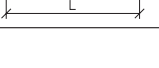

	↔ <b>stufenlos</b> / stepless / régl. continu régl. progressive / sin escalones / sem degraus бесступенчатый kg	m/min
30 kW FU WIW 240 MZ 403	<b>5 Lagen</b> Layers Couches Avvolgimenti Camadas Сараs Слоёв	<b>1</b> 6000 0 ↔ 26 550 0 ↔ 126
	100,0 m	
174,0 m**		
 <p><b>1</b> Gang / Speed / Vitesse Marcia / Velocidad Velocidade / Передача</p>		

\*\* Weitere Hublastdaten: siehe Betriebsanleitung. / Further hoist load data: see instruction manual. / Autres données de la charge de levage: voir manuel d'instruction. / Altri dati sui carichi sollevati: consultare il manuale d'istruzione. / Alturas bajo grancho superiores según manual. / Outras tabelas de carga: consultar manual de instruções. / Другие данные по весу поднимаемых грузов: см. инструкцию по эксплуатации.

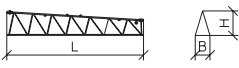
**Kolli-Liste** Packing List / Liste de colisage / Lista dei colli  
Lista de contenido / Lista de embalagem / Упаковочный лист

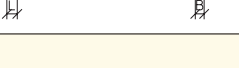
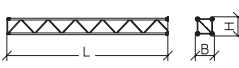
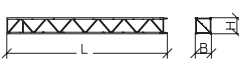
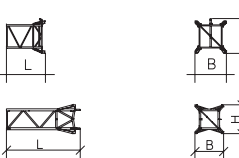
Montagewichte: siehe Betriebsanleitung. / Erection weights: see instruction manual. / Poids de montage: voir manuel de service. / Pesi di montaggio: vedere manuale d'uso. / Peso para el montaje: según manual. / Pesos de montagem: vejäm-se es instruções p. uso. / Масса монтируемых частей: см. инструкцию по эксплуатации.

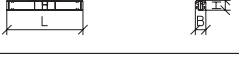
Kranoberteil		Upper part of crane / Partie supérieure de grue / Parte superiore della gru Parte superior grúa / Parte superior do guindaste / Верхняя часть крана	L (m)	B (m)	H (m)	kg*		
Pos. Item	Anz. Qty.	<b>Drehbühne mit Podesten</b> / Slewing platform with platforms Plate-forme tournante avec plates-formes / Piattaforma girevole con pedana / Plataforma giratoria con plataforma Plataforma giratória com plataforma / Поворотная платформа с площадками			2,71	2,90	2,58	6220
1	1							
2	1	<b>Drehbühne</b> / Slewing platform / Ensemble mât-cabine / Piattaforma girevole / Conjunto plataforma de giro / Plataforma giratória Поворотная платформа			2,71	2,25	2,58	5940
3	1	<b>Podeste</b> / Platforms / Plates-formes Pedana / Plataformas / Plataformas Площадки			2,33 2,40 2,33	0,50 1,04 0,65	1,36 1,33 1,36	120 150 120
4	1	<b>Kabine</b> / Cabin / Cabine Cabina / Cabina / Cabina Кабина			1,35	2,82	2,28	610
5	1	<b>Gegenausleger</b> / Counter-jib / Contre-flèche Controfreccia / Contrapluma / Contra-lança Консоль противовеса			11,98	1,40	0,81	2720
6	1	<b>Podeste Gegenausleger</b> / Counter-jib platforms Plates-formes de contre-flèche / Ballatoi controfreccia Plataforma contra-pluma / Plataforma contra-lança Площадки консоли противовеса			4,00	0,69	1,35	180
7	1	<b>Ausleger-Anlenkstück</b> / Jib heel section / Pied de flèche Sezione articolata braccio / Pluma tramo primero / Base articulada de lança / Корневая секция стрелы			10,01	1,34	2,23	① 2010

Pos. Item Rep. Voce Pos. Ref. Pos.	Anz. Qty. Qte. Qta. Cant. Cant. Cant.				L (m)	B (m)	H (m)	kg*
8	1	<b>Ausleger-Zwischenstück</b> / Intermediate jib section Elément intermédiaire de flèche / Sezione intermedia braccio / Tramo intermedio pluma / Peça complementar da lança / Промежуточная секция стрелы			5,27 10,26 2,72 7,71 5,19 5,17	1,20 1,20 1,20 1,20 1,20 1,20	2,15 2,14 1,48 1,48 1,46 1,45	② 740 ③ 1180 ⑤ 200 ⑥ 500 ⑦ 230 ⑧ 200
9	1	<b>Ausleger-Zwischenstück</b> / Intermediate jib section Elément intermédiaire de flèche / Sezione intermedia braccio / Tramo intermedio pluma / Peça complementar da lança / Промежуточная секция стрелы			10,22	1,20	2,08	④ 850
10	1	<b>Ausleger-Kopfstück</b> / Jib head section / Pointe de flèche / Punta braccio / Tramo punta de pluma Cabeça de lança / Концевая секция стрелы			1,40	1,21	0,46	⑨ 80
11	1	<b>Laufkatze</b> / Trolley / Chariot Carrello / Carrito / Carrinho Грузовая тележка			1,62	1,38	1,29	530
12	1	<b>Fahrkorb</b> / Maintenance cage / Nacelle d'entretien Cestello di manutenzione / Plataforma de mantenimiento / Передвижная платформа			0,78	0,66	1,25	35
<b>Turm</b>		<b>Tower / Mât / Torre Torre / Torre / Башня</b>						
13	1	<b>Grundturmstück</b> / Base tower section / Mât de base Elemento di torre base / Tramo torre base Peça de base de torre / Секция основания			100 LC 12,00 120 HC 6,85 120 HC 10,00	2,03 1,80 1,80	2,03 1,80 1,80	3820 2610 3530
14	1	<b>Turmstück</b> / Tower section Elément de mât / Elemento di torre Tramo torre / Torre / Башенная секция		3,90 m 5,85 m 11,70 m	100 LC 4,17 100 LC 6,12 100 LC 11,97 120 HC 2,50 120 HC 5,00 120 HC 10,00 120 HC 12,50	1,80 1,80 1,80 1,80 1,80 1,80 1,80	1,80 1,80 1,80 1,80 1,80 1,80 1,80	1190 1620 2930 1090 1830 3430 4200
15	1	<b>Kletterturmstück</b> / Climbing tower section Elément de hissage de mât / Elemento torre di telescopaggio / Tramo de trepado Tramo de telescopagem / Секция самоподъема			120 HC 2,75 100 LC 4,17	2,20 2,26	2,45 2,26	1450 1440
<b>Klettereinrichtung</b>		<b>Climbing equipment / Equipement de télescopage / Attrezzatura per allungamento della gru Equipo de trepado / Acesórios p. subida no edificio / Обойма наращивания</b>						
16	1	<b>Führungsstück kpl.</b> / Guide section cpl. / Cage télescopique cpl. / Gabbia di sopraelevazione compl. Torre de montaje completa / Peça de guia compl. Направляющая секция в сб.			100 LC 8,74 120 HC 6,45 120 HC 9,60	2,27 2,10 2,10	2,35 2,42 2,42	3130 3500 4440
17	1	<b>Hydraulikanlage, Stütz- und Klettertraverse</b> / Hydraulic unit, supporting and climbing cross members / Système hydraul. avec traverses d'appui et de télescop. Sist. idraul., travessa di appoggio e allugam. gru / Sistema hidráulico con travessa de apoio y trepado / Instalação hidráulica, travessa de apoio e subida / Гидроагрегат, стойка-упор и траверса обоймы наращивания			100 LC 2,00 120 HC 2,87	0,90 2,12	0,80 1,06	640 1050
<b>Fundamentkreuz</b>		<b>Cruciform base / Châssis en croix / Crociera Carro de guindaste / Base cruciforme / Фундаментная крестовина</b>						
18	1	<b>Tragholm I</b> / Arm I / Longeron I Longherone I / Travessa I Braço I / Несущая балка I		(3,8 m) (4,5 m)	100 LC 5,68 100 LC 6,67 120 HC 7,12	0,71 0,71 0,78	0,91 0,91 0,65	2090 2190 950
19	1	<b>Tragholm II</b> / Arm II / Longeron II Longherone II / Travessa II Braço II / Несущая балка II		(3,8 m) (4,5 m)	100 LC 5,68 100 LC 6,67 120 HC 3,45	0,78 0,78 0,56	0,74 0,74 0,55	1870 1970 408
20	2	<b>Fahrschemel mit Antrieb</b> / Rail bogie with drive Bogie moteur / Telajo con gruppia propulsore Caja rodillo motriz / Quadra sem grupa de propulsão Подрамник с приводом			100 LC 1,31 120 HC 1,38	0,66 0,88	0,61 0,87	630 900
21	2	<b>Fahrschemel ohne Antrieb</b> / Rail bogie without drive Bogie fou / Telajo senza gruppia propulsore / Caja rodillo conducido / Quadra com grupa de propulsão Подрамник без привода			100 LC 1,04 120 HC 1,17	0,33 0,60	0,61 0,87	330 860

\* Einzelgewichte. / Single weights. / Poids individuels. / Singoli pesi. / Pesos unitarios. / Pesos de peças componentes. / Индивидуальный вес.

**Konstruktionsänderungen vorbehalten!** / Subject to alterations! / Sous réserves de modifications! / Reservato il diritto di modifiche strutturali!  
¡Sujeto a modificaciones! / Salvo modificação da construação! / Права на внесение конструкторских изменений сохраняются!

**Sämtliche Angaben erfolgen ohne Gewähr.** / This information is supplied without liability. / Ces renseignements sont sans garantie. / Tutte le indicazioni fornite senza garanzia. / Declinamos toda responsabilidad derivada de la información proporcionada. / Declinamos qualquer responsabilidade quanto à informação fornecida. / Все данные указаны без обязательств.

121 P – 5845 • EN 14439:2009 – DIN 15018-H1/B3 • BGL C.0.10.0100 • 04.10 / 7

Printed in Germany.