

SAE Net Horsepower: 362 HP (270 kW)
Operating Weight: 112,900 lbs. (51 200 kg)
Digging Depth: 24 ft 10 in (7.57 m)

490x4



PERFORMANCE
SPECIFICATIONS

Link-Belt
EXCAVATORS



PERFORMANCE, PRODUCTIVITY AND RELIABILITY COME STANDARD

Link-Belt X4 Series excavators are built to exceed your expectations. We redesigned the control spools and incorporated spool stroke control (SSC) functions into the hydraulic system to reduce pressure loss and distribute hydraulic oil more smoothly, increasing cycle times by 10%. Expect more power and fuel efficiency, thanks to an innovative Final Tier 4 engine that delivers up to 5% improved fuel consumption, **without a Diesel Particulate Filter (DPF) to maintain or replace!** Settle in to the roomiest, most accommodating cab in its class, with more legroom and a new high-back, heated seat for shift-long comfort. Daily maintenance is a snap, with ground-level access to all service points, easily opened by hand.



INNOVATION AND ATTENTION TO DETAILS AT EVERY LEVEL



- Three power modes (Speed Priority, Heavy and Applied Power) let you **choose the best blend of power, precision and fuel savings** for the work you're doing



- EPA Final Tier 4 engine is **fuel efficient without sacrificing power**



- **No DPF** to ever worry about!
- 2 - 3% DEF (Diesel Exhaust Fluid) consumption rate, combined with one of the largest DEF tank capacities lets you work long hours between refills



- Ground level access to routine service points lets you **cut daily maintenance down to just minutes**



- Quiet, pressurized cab offers **excellent visibility and comfortable, best-in-class seating**
- Enough floor space to **accommodate the largest of work boots**, with cup holders and roomy storage compartments for cell phones, snacks and other personal items



- Dual cab working lights are standard, or choose optional LEDs for **added visibility**

- Ergonomic joysticks **fit your hand perfectly**



- 7" high-definition LCD monitor **keeps you connected to your machine and work environment**



- RemoteCARE[®] telematics **keeps a watchful eye** on performance, maintenance intervals and theft deterrence



- Full-time, rear-view camera display is standard; add the WAVES[™] option for a **seamless 270° view around the machine**

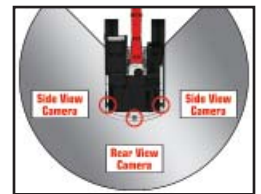

- Structural improvements to the boom and arm **reduce stress and provide greater durability**



- Robust undercarriage features **larger track rollers and thicker plating for longer life**
- Unique side-frame design **reduces dirt accumulation** and is **easier to clean**



*All improvements and percentage increases are in reference to Link-Belt X3 Series excavators, unless otherwise stated

**QUICK AND RESPONSIVE
TO TAKE ON TOUGH CHALLENGES**



Greater digging power and increased lift capacities are the result of our innovative Spool Stroke Control (SSC) system, which reduces pressure loss and distributes hydraulic oil more smoothly. Pilot pressure sensors detect the type of work being done—such as digging or leveling—and then relays that data to proportional solenoid valves that quickly determine where optimal hydraulic pressures should be directed for that operation.

Two electronically-controlled Kawasaki variable-displacement axial-piston pumps and one Kawasaki gear pump assure that hydraulic power is delivered precisely when and where it's needed. At the same time, hydraulic flows in noncritical areas of the system are reduced.

The result is better breakout force, more lifting strength and faster machine response. You'll dig, swing and dump quicker than ever before... with 10% faster cycle times and improved fuel efficiency!

- Proprietary hydraulic system
- New control valve with larger ports; less restriction means improved hydraulic flow for increased performance
- Electronically-controlled pumps for improved cycle times, quicker response and more efficient machine operation
- Move more dirt per gallon of fuel

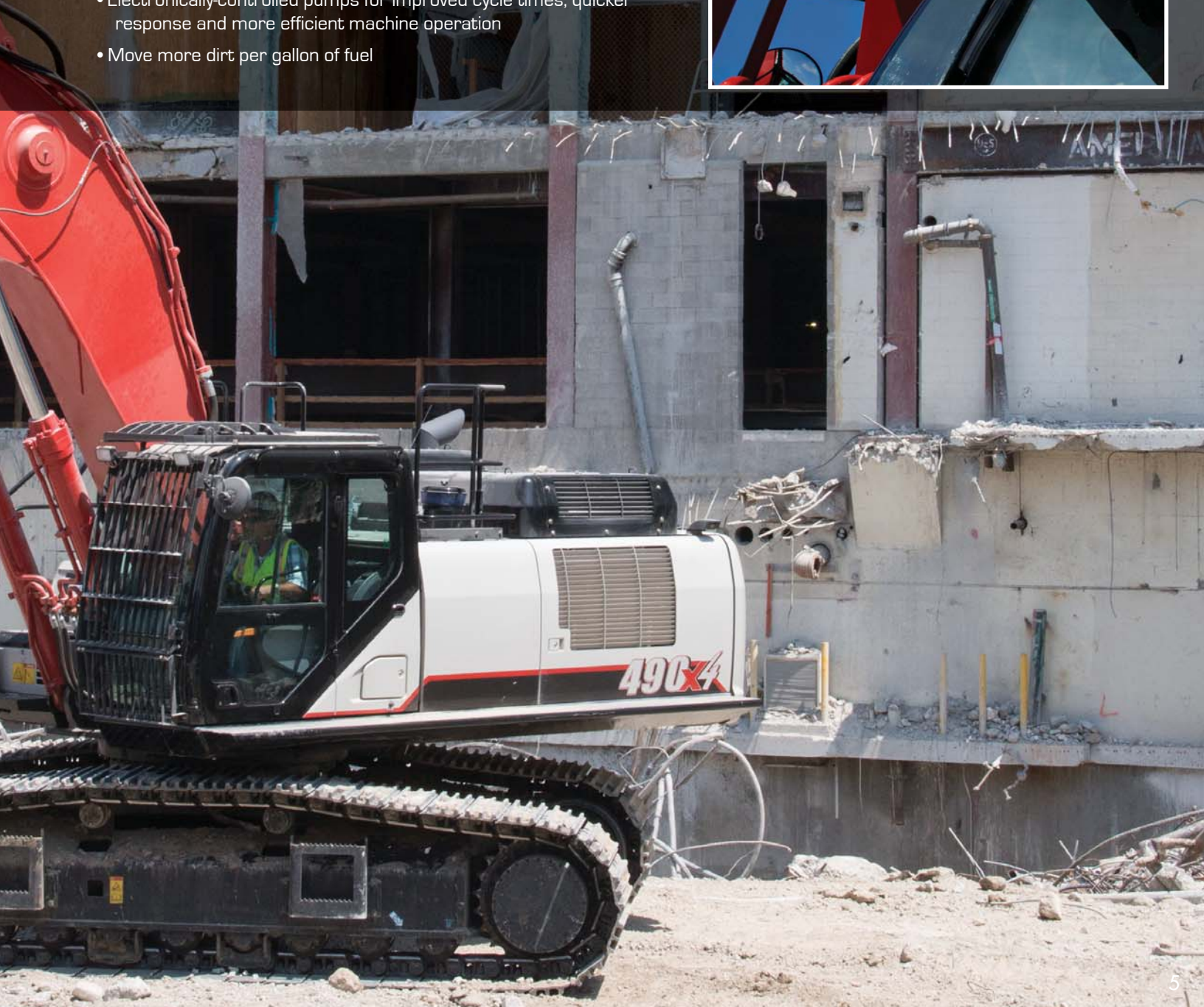

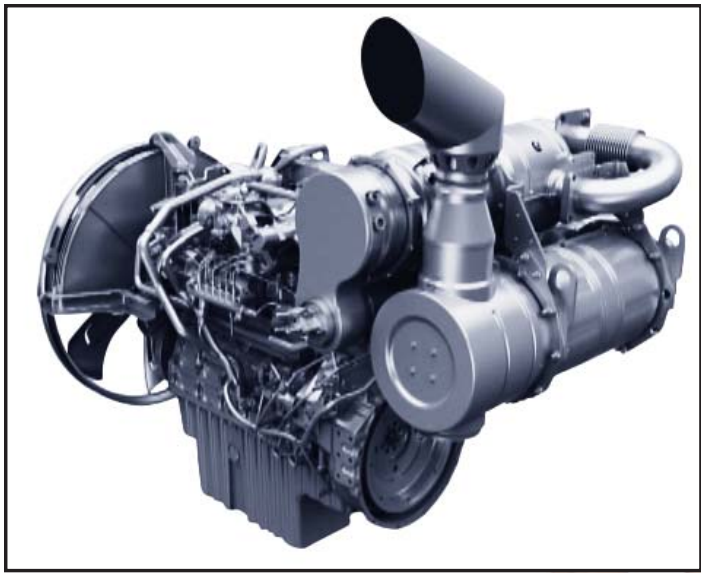

The X4 Series features innovative EPA-certified Final Tier 4 engines from Isuzu that strike the ultimate balance between power, productivity and fuel efficiency. You'll experience up to 5% improved fuel efficiency, without having to worry about costly diesel particulate filters (DPF) to maintain or replace. Three engine modes provide reliable power and control for any machine application. Choose Speed Priority (SP mode) to get jobs done quickly, Heavy (H mode) for the best blend of power and fuel savings or Applied Power (A mode), with 13 different RPM settings for precise control of heavy lifting, fine grading or leveling work.

- EPA-certified Tier 4 Final
- No DPF to maintain
- Up to 5% improved fuel economy
- 500-hr. fuel filters service intervals
- 8 diesel tank refills per 1 diesel exhaust fluid (DEF) refill
- 2 - 3% DEF consumption rate
- Two-stage DEF anti-freeze system for protection in harsh operating conditions
- 30 hrs. between SCR regenerations, only takes 5-10 minutes to complete!
- VGT (Variable Geometry Turbocharger)



POWER AND EFFICIENCY WITHOUT COMPROMISE





The X4 Series offers the most advanced and roomiest cab in its class. Comfortable, automotive-grade high-back seat with head rest provides superior lumbar back support. With a longer and wider seating surface, it reclines to a 155° maximum reclining angle to create a relaxed environment during breaks. Air-suspension seat is standard with tilting adjustment and seat heaters available as options.

The cab layout also includes ergonomically-designed arm rests that move with console, maintaining a constant distance between joysticks and arm rests no matter how the seat is adjusted.

- Quiet, pressurized cab
- Joysticks with easy-to-hold grip and switches
- Handy 'radio mute' and one touch wiper switch
- Optional proportional joysticks w/ auxiliary hydraulics control
- Cup holder and storage areas for cell phones and other small items
- Dual halogen cab lights standard
- Full time rear camera display
- Optional RH & LH side cameras
- ROPS and FOPS Level 1 certified, optional FOPS Level 2 head guard available
- Optional LED lights use less energy and are 3X brighter!
- Optional retractable rear window shade
- Optional front sun visor
- Improved radio with USB port and Bluetooth for hands-free communication.





High-Definition LCD monitor has a full-color 7" display that rivals the resolution found in luxury automobiles. Controls are easy to read and easy to use. The rear-view camera activates automatically whenever the machine is started, and sight guidelines have been added for increased safety.

- Anti-glare coating on screen
- Track up to 14 service maintenance reminders
- System/machine warning messages
- Easy-to-use auto idle and auto shutdown feature
- Select and set up attachments: 5 presets for breakers; 5 presets for crushers
- In-cab flow & pressure controls for auxiliary hydraulics
- Anti-theft system
- Auto-adjusts for time and calendar
- 24 languages available
- Ability to view fuel consumption

270° WAVES™

WIDE-ANGLE VISUAL ENHANCEMENT SYSTEM

For the ultimate in visibility, X4 machines can be fitted with the Wide Angle Visual Enhancement System - or WAVES for short. Using three closed-circuit cameras, this optional viewing system provides an unbelievable 270° visual coverage around the machine, eliminating any potential blind spots from the operator's line of sight. WAVES images can be displayed on the standard X4 monitor.

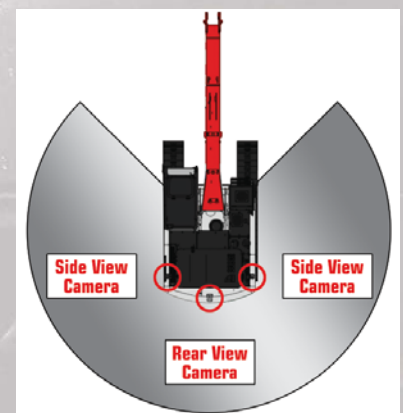



GET WORKING FAST WITH EASY ACCESS TO SERVICE POINTS

Maintenance is a snap, with ground level access to all routine service points, including batteries, fuel filters, engine oil filter, dual-element air filter and cab fresh air filter.

- Radiator screens are easy to remove and clean from ground level...no tools needed!
- A/C Condenser tilts for easy cleaning and maintenance
- Easy battery compartment access; 2 hand-turn knobs
- Improved battery disconnect switch with no keys needed
- Convenient ground-level sample ports in pump compartment
- Green drain plug and hose
- More data collection points
- Automatic door locking mechanism on side door
- Quick and easy access to grease all attachment pivot points
- Grease cylinder track adjusters make adjusting track tension a breeze
- New undercarriage side frame design enables easier cleaning
- In-cab reminders track 14 different maintenance procedures



TELEMATICS WITH NO SUBSCRIPTION FEE

RemoteCARE® lets you remotely monitor and track machine location, operational performance, working status and periodic maintenance requirements - now at no cost to you. It tracks and records both routine and major service intervals for your machines, giving you more flexibility and control when scheduling maintenance procedures. It also lets you be more proactive if potential failure conditions arise; whenever a diagnostic trouble code (DTC) is detected, a warning message appears on the machine display, and an e-mail alert is automatically sent to you. RemoteCARE also assists in theft prevention by offering 24/7 surveillance and geofencing capabilities.

FREE Subscription Includes:

- ✓ 24/7 Remote Monitoring and Security
- ✓ Machine Location
- ✓ Geo-fence & Curfew Range
- ✓ Actual Fuel Consumption
- ✓ Fuel Levels
- ✓ Hour Meter Reading
- ✓ Radiator Water Temperature
- ✓ Machine Working Time/Idle Time
- ✓ Attachment Working Hours
- ✓ Working Modes
- ✓ Service Maintenance Reminders
- ✓ Service Warnings



REMOTE CARE® APP

Manage your Link-Belt equipment with this user friendly telematics management tool with GPS technology. The RemoteCARE App provides timely and reliable machine utilization – as well as assisting in DTC notifications. With RemoteCARE you will be able to remotely monitor and track your machine's location, operational performance, and working status. Contact your local Link-Belt dealer for questions.

App features include...

- Machine location
- Fuel consumption
- Utilization report
- Fuel efficiency
- Analytical snapshots
- Idle rate
- DTC notification history
- Favorite list

Download Apple or Android app at lbxco.com/apps for phone and tablet.



BUILT STRONG TO HANDLE ANYTHING

X4 machines are more rugged and durable, with robust structural improvements to the boom & arm structures, along with improvements to lower frame and travel components.



Boom & Arm

- Improved boss shapes reduce stress on boom and arm pin
- Cast boom tip for increased reliability

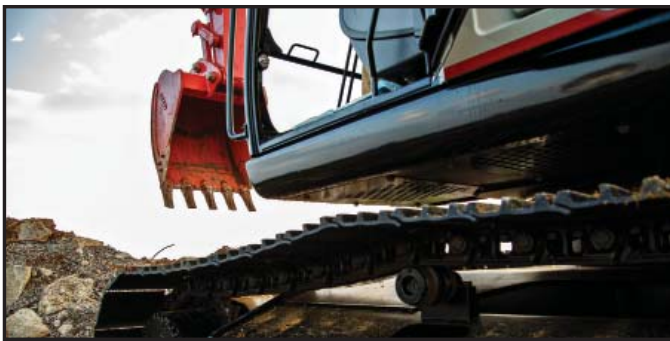

Lowers

- Thicker travel motor case - 28% increase
- 9% more stroke recoil spring
- 28% wider idler hub
- Unique side-frame design reduces dirt accumulation and is easier to clean.



CUSTOMER SUPPORT IS JUST A CALL AWAY

A network of Link-Belt Excavator dealers across the U.S. and Canada is waiting to serve you. Expect fast and dependable service, backed by 24/7 access to parts.

Rock-Solid Warranty Coverage

All X4 machines are backed by a 3-year/3,000 hour Full Machine Warranty*, 2-year/3,000 hour Engine Warranty (2,000 hrs. electrical parts), 3-year/5,000 hour Powertrain Warranty, 3-year/10,000 hour XtraStructure Warranty, 5-year/3,000 hour EPA Emissions Warranty and participation in the X4 Fluids Analysis Program for the life of the warranty. Extended warranty coverage packages are also available.

**Applies to 2018 or newer serialized machines only.*



SPECIFICATIONS



Engine

Isuzu AQ-6UZ1X Final Tier 4 turbocharged diesel engine with electronic control (ECM) and high pressure common-rail fuel injection, 6-cylinder, water-cooled, Exhaust Gas Recirculation (EGR), Intercooler, Variable-Geometry Turbocharger (VGT), Diesel Oxidation Catalyst (DOC) and Selective Catalytic Reduction (SCR) system with Dosing Control Module and heated DEF lines and tank. Electronic fuel pump and priming, Fuel cooler, Auto-idle start, Auto warm-up, EPF engine protection, dual-stage fuel filtration, remote oil filter, engine oil sample port, green plug oil drain, double element air filter.

SAE net horsepower	
without fan pump	362 hp (270 kW) @ 2,000 rpm
with fan pump	329 hp (245 kW) @ 2,000 rpm
Displacement	600 cu in (9.8 L)
Maximum Torque	1,005 lbf-ft (1 363 Nm) @ 1,500 rpm
Starter	24V - 5.5kW
Alternator	50 amp
Battery	(2) 12-volt 128 amp hours



Cab and Controls

ROPS and FOPS Level 1 certified with automatic climate control A/C and heat with defroster, 7" LCD Hi-Definition color monitor with full time rear view camera display, fuel efficiency gauge, low-effort joysticks are pre-wired for auxiliary hydraulics, dual cab lights, control pattern changer, safety glass windows, sunroof with sunshade, shockless cab suspension with four fluid cab mounts, SCM High-Back reclining air-suspension seat, sliding 4-position tilting control consoles, Bluetooth technology, AM/FM sound system with USB and MP3 auxiliary input jack, digital clock, dome light, seat belt, coat hook, cup holder, storage compartments, floor mat, footrests, ashtray, 24V cigarette lighter, 12V outlet, travel alarm, handrails, mirrors, side-entry cab filter, spare parts kit.

Three selectable work modes, RemoteCARE Telematics GPS system, anti-theft password protection system, onboard self-diagnostic system with memory and service interval reminders, auto idling system, one-touch decelerator, auto-idle engine shutdown, auto-power boost, neutral safety start, gate-lock safety shutoff.



Hydraulic System

Open-center system, two variable-displacement electronically controlled axial-piston pumps and one gear pump for pilot controls, main control valve with one 4-spool section and one 5-spool section with auxiliary spool: stackable, Auxiliary Control System, oil cooler, Auto-Power boost, anti-drift valves, 6 micron return filter, firewall, hydraulic oil sample port.

Hydraulic Pumps

Pump Output	2 x 96.2 gpm (364 L/min)
Pilot Pump Maximum Flow	7.9 gpm (30 L/min)

Relief Valve Settings

Boom Up/Arm/Bucket	4,550 psi (31.4 MPa)
in Power Boost	4,980 psi (34.3 MPa)
Boom Down	3,560 psi (24.5 MPa)
Swing Circuit	4,270 psi (29.4 MPa)
Travel Circuit	4,980 psi (34.3 MPa)

Hydraulic Cylinders

	number of cylinders - bore x rod x stroke
Boom	2 - 6.7" x 4.5" x 61.0" (170 mm x 115 mm x 1 550 mm)
Arm	1 - 7.5" x 5.1" x 75.6" (190 mm x 130 mm x 1 920 mm)
Bucket	6.5" x 4.5" x 50.6" (165 mm x 115 mm x 1 285 mm)



Swing

Planetary reduction powered by axial-piston motor, Internal ring gear with grease cavity for swing pinion, Swing bearing is single-row, shear type ball bearing, Mechanical disc swing brake, Auto-power swing.

Swing Speed	9.1 rpm
Tail Swing	12' 3"(3.73 m)
Swing Torque	111,000 lbf-ft (150.0 kNm)

Undercarriage

Fixed or expandable sideframes with 17' 11"(5.45 m) LC long undercarriage, Sealed and strutted track chain with track guide, Sealed rollers and idlers, Two-speed independent hydrostatic travel with compact planetary final drive, Disc type brakes, Adjustable track tension, Carbody belly pan.

Carrier Rollers	
Fixed sideframe undercarriage	2 per Side
Expandable sideframe undercarriage	3 per Side
Track Rollers	9 per Side
Track Link Pitch	9.00"(229 mm)
Shoes	50 per Side
Shoe Width	35.5"(900 mm)
Ground Pressure	
Fixed sideframe undercarriage	8.27 psi (0.057 MPa)
Expandable sideframe undercarriage	8.41 psi (0.058 MPa)



Travel System

Two-speed independent hydrostatic travel with compact axial-piston motors, Hydraulic motor powered output shaft coupled to a planetary reduction drive and track sprocket, All hydraulic components mounted within the width of side frame, Automatic downshift for high torque to overcome obstacles, Spring-applied hydraulic release parking brake built into each motor, Travel motors equipped with counterbalance valve to prevent over-speeding down an incline, Single-pedal straight line travel.

Travel Speeds	2.0 - 3.3 mph (3.2 - 5.3 km/h)
Drawbar Pull	76,200 lbf (339 kN)
Gradeability	70% (35°)



Attachment

Boom	22' 11" (6.98 m)
Available Arms	Digging Force
• 11' 1" (3.38 m)	45,200 lbf (201 kN)
with Auto Power Boost	49,500 lbf (220 kN)
• 8' 4" (2.53 m)	55,300 lbf (246 kN)
with Auto Power Boost	60,500 lbf (269 kN)
• 13' 2" (4.00 m)	39,800 lbf (177 kN)
with Auto Power Boost	43,400 lbf (193 kN)
• 15' 11" (4.85 m)	35,500 lbf (158 kN)
with Auto Power Boost	38,900 lbf (173 kN)
• Bucket Digging Force	55,500 lbf (247 kN)
with Auto Power Boost	60,700 lbf (270 kN)



Lubricant & Coolant Capacity

Fuel Tank	172 Gallons (650.0 Liters)
Hydraulic System	122 Gallons (460.0 Liters)
Hydraulic Tank	61 Gallons (230.0 Liters)
Final Drive (per side)	4.0 Gallons (15.0 Liters)
Swing Drive	2.8 Gallons (10.5 Liters)
Engine Oil	10.8 Gallons (41.0 Liters)
DEF Tank	40 Gallons (152.0 Liters)
Coolant System	14.6 Gallons (55.1 Liters)



Operating Weight

Working weight with 35.5" (900 mm) shoes, 22' 11" (6.98 m) boom, 11' 1" (3.38 m) arm, 3,373 lb. (1 530 kg) bucket, 22,000 lb. (10 000 kg) counterweight

Fixed sideframe undercarriage	109,800 lbs. (49 800 kg)
Expandable sideframe undercarriage	112,900 lbs. (51 200 kg)

Mass Excavator

Working weight with 35.5" (900 mm) shoes, 21' 6" (6.55 m) boom, 8' 4" (2.53 m) arm, 5,300 lb. (2 400 kg) bucket, 22,000 lb. (10 000 kg) counterweight

Fixed sideframe undercarriage	112,200 lbs. (50 900 kg)
Expandable sideframe undercarriage	115,100 lbs. (52 200 kg)

WORKING RANGE & TRAVEL DIMENSIONS

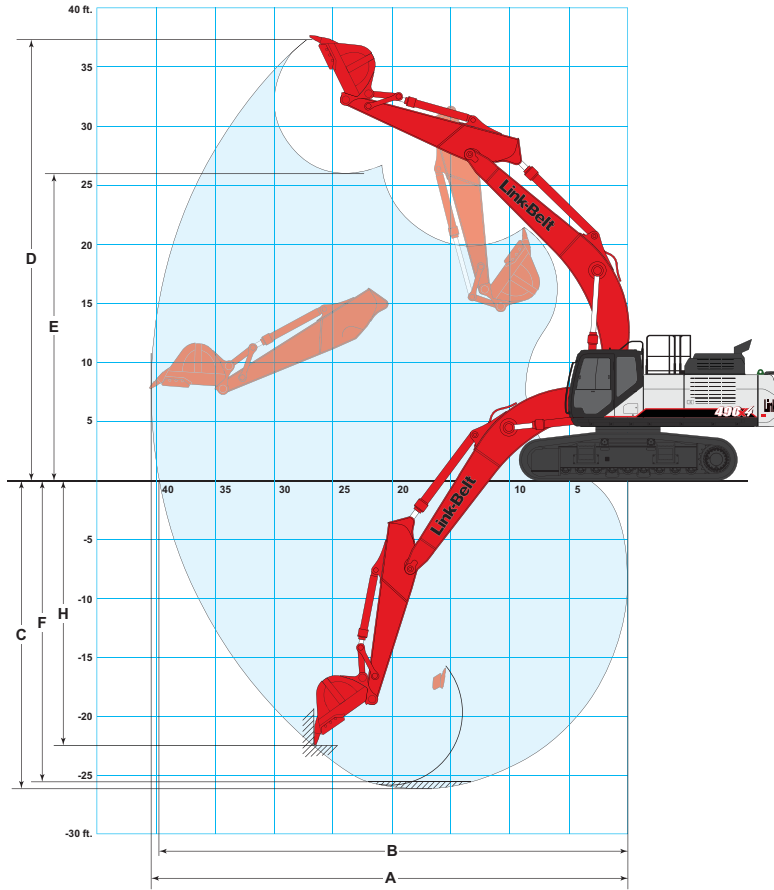

490 X4 with fixed sideframe				
Machine Equipped with 22' 11" (6.98 m) Boom	11' 1" Arm (3.38 m)	8' 4" Arm (2.53 m)	13' 2" Arm (4.00 m)	15' 11" Arm (4.85 m)
A. Maximum reach	39' 3" (11.97 m)	36' 10" (11.22 m)	41' 1" (12.52 m)	43' 6" (13.27 m)
B. Maximum reach @ ground level	38' 7" (11.75 m)	36' 0" (10.98 m)	40' 4" (12.30 m)	42' 10" (13.06 m)
C. Maximum dig depth	25' 4" (7.72 m)	22' 6" (6.87 m)	27' 4" (8.34 m)	30' 2" (9.20 m)
D. Maximum dig height	36' 5" (11.10 m)	35' 7" (10.85 m)	36' 11" (11.26 m)	37' 7" (11.46 m)
E. Maximum dump height	25' 3" (7.69 m)	24' 4" (7.41 m)	25' 10" (7.87 m)	26' 6" (8.07 m)
F. Digging depth 8' (2.44 m) level bottom	24' 10" (7.58 m)	21' 11" (6.69 m)	26' 11" (8.21 m)	29' 9" (9.08 m)
G. Bucket rotation	176°	176°	176°	176°
H. Maximum vertical wall depth	21' 9" (6.64 m)	19' 8" (5.99 m)	23' 4" (7.12 m)	26' 1" (7.96 m)

490 X4 with expandable sideframe				
Machine Equipped with 22' 11" (6.98 m) Boom	11' 1" Arm (3.38 m)	8' 4" Arm (2.53 m)	13' 2" Arm (4.00 m)	15' 11" Arm (4.85 m)
A. Maximum reach	39' 3" (11.97 m)	36' 10" (11.22 m)	41' 1" (12.52 m)	43' 6" (13.27 m)
B. Maximum reach @ ground level	38' 5" (11.72 m)	35' 11" (10.95 m)	40' 3" (12.27 m)	42' 9" (13.03 m)
C. Maximum dig depth	24' 10" (7.57 m)	22' 1" (6.72 m)	26' 10" (8.19 m)	29' 8" (9.05 m)
D. Maximum dig height	36' 11" (11.25 m)	36' 1" (11.00 m)	37' 5" (11.41 m)	38' 1" (11.61 m)
E. Maximum dump height	25' 9" (7.84 m)	24' 10" (7.56 m)	26' 4" (8.02 m)	27' 0" (8.22 m)
F. Digging depth 8' (2.44 m) level bottom	24' 5" (7.43 m)	21' 5" (6.54 m)	26' 5" (8.06 m)	29' 4" (8.93 m)
G. Bucket rotation	176°	176°	176°	176°
H. Maximum vertical wall depth	21' 4" (6.49 m)	19' 2" (5.84 m)	22' 10" (6.97 m)	25' 7" (7.81 m)

490 X4 Mass excavator with fixed sideframe		490 X4 Mass excavator with expandable sideframe	
Machine Equipped with 21' 6" (6.55 m) Boom	8' 4" Arm (2.53 m)	Machine Equipped with 21' 6" (6.55 m) Boom	8' 4" Arm (2.53 m)
A. Maximum reach	35' 5" (10.80 m)	A. Maximum reach	35' 5" (10.80 m)
B. Maximum reach @ ground level	34' 7" (10.55 m)	B. Maximum reach @ ground level	34' 6" (10.52 m)
C. Maximum dig depth	21' 4" (6.49 m)	C. Maximum dig depth	20' 10" (6.34 m)
D. Maximum dig height	34' 7" (10.55 m)	D. Maximum dig height	35' 1" (10.70 m)
E. Maximum dump height	23' 6" (7.16 m)	E. Maximum dump height	24' 0" (7.31 m)
F. Digging depth 8' (2.44 m) level bottom	20' 9" (6.32 m)	F. Digging depth 8' (2.44 m) level bottom	20' 3" (6.17 m)
G. Bucket rotation	160°	G. Bucket rotation	160°
H. Maximum vertical wall depth	17' 4" (5.29 m)	H. Maximum vertical wall depth	16' 10" (5.14 m)

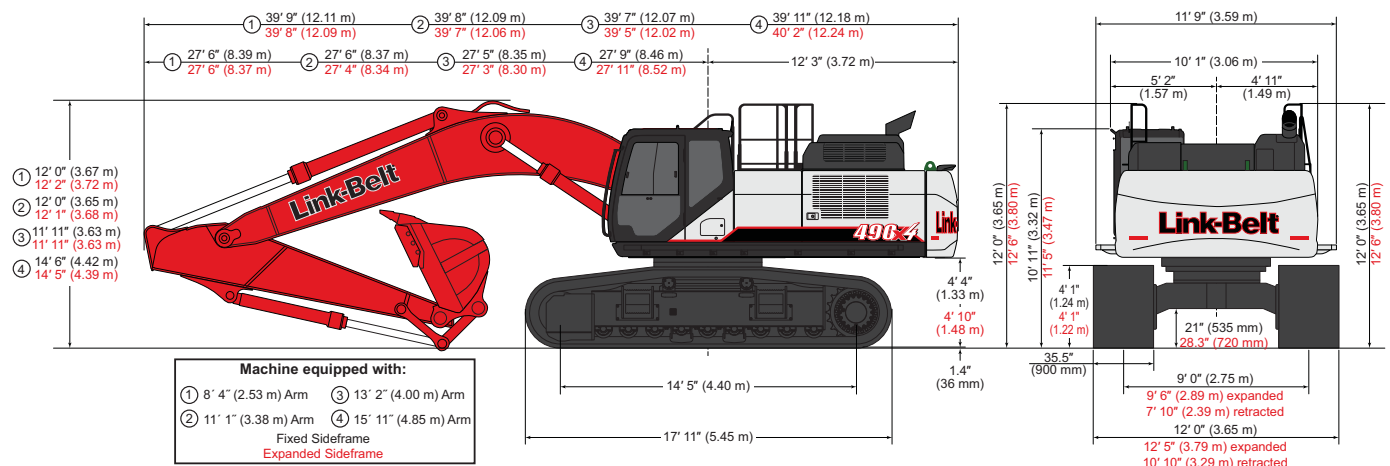





LIFT CAPACITIES

Radius of Load - Fixed Undercarriage																	
11' 1" (3.38 m) Arm with 22' 11" (6.98 m) Boom and 3,200 lb. (1 460 kg) Bucket with Power-Boost Applied																	
End	Side	5' 0" (1.5 m)		10' 0" (3.0 m)		15' 0" (4.5 m)		20' 0" (6.0 m)		25' 0" (7.5 m)		30' 0" (9.0 m)		35' 0" (10.5 m)		Max. Reach	
		End	Side	End	Side	End	Side	End	Side	End	Side	End	Side	End	Side	End	Side
+30' 0"	lbs											14,250*	14,250*			12,950*	12,950*
(9.0 m)	kg											7 400*	7 400*			5 830*	5 830*
+25' 0"	lbs											18,200*	17,600			12,400*	12,400*
(7.5 m)	kg											8 430*	8 180*			5 620*	5 620*
+20' 0"	lbs									21,400*	21,400*	19,900*	17,150	16,050*	12,750	12,300*	12,000
(6.0 m)	kg									9 820*	9 820*	9 090*	7 990	8 090*	5 960	5 590*	5 400
+15' 0"	lbs							28,950*	28,950*	23,850*	22,500	20,750*	16,500	18,350*	12,400	12,550*	10,950
(4.5 m)	kg							13 450*	13 450*	11 030*	10 440	9 540*	7 680	8 440*	5 800	5 690*	4 940
+10' 0"	lbs					45,200*	45,200*	33,850*	30,150	26,550*	21,250	22,250*	15,750	19,200*	12,000	13,000*	10,400
(3.0 m)	kg					20 890*	20 890*	15 690*	13 980	12 290*	9 860	10 260*	7 330	8 840*	5 610	5 920*	4 710
+5' 0"	lbs					50,300*	43,350	37,250*	28,250	28,650*	20,150	23,400*	15,100	19,700*	11,650	13,850*	10,300
(1.5 m)	kg					23 220*	20 130	17 230*	13 100	13 250*	9 350	10 810*	7 020	9 100*	5 430	6 300*	4 670
Ground Line	lbs			21,000*	21,000*	51,750*	41,600	38,400*	26,950	29,600*	19,300	23,800*	14,600	19,600*	11,400	15,150*	10,650
	kg			9 220*	9 220*	22 400*	19 290	17 740*	12 520	13 680*	8 970	11 020*	6 790	9 090*	5 310	6 870*	4 820
-5' 0"	lbs	22,850*	22,850*	33,100*	33,100*	51,650*	41,850	37,950*	26,600	29,350*	19,000	23,400*	14,400			17,200*	11,500
(1.5 m)	kg	10 200*	10 200*	14 750*	14 750*	23 800*	19 400*	17 530*	12 350	13 560*	8 820	10 850*	6 690			7 790*	5 210
-10' 0"	lbs	36,250*	36,250*	45,900*	45,900*	47,900*	42,400	36,000*	26,850	27,850*	19,150	21,450*	14,650			18,150*	13,150
(3.0 m)	kg	16 280*	16 280*	20 370*	20 370*	22 110*	19 740	16 650*	12 460	12 920*	8 890	10 040*	6 800			8 240*	5 940
-15' 0"	lbs			55,550*	55,550*	41,150*	41,150*	31,400*	27,450	23,700*	19,800					17,450*	16,250
(4.5 m)	kg			25 750*	25 750*	19 110*	19 110*	14 620*	12 750*	11 150*	9 180					7 950*	7 290
-20' 0"	lbs					29,850*	29,850*	22,100*	22,100*							15,450*	15,450*
(6.0 m)	kg					14 140*	14 140*	10 630*	10 630*							7 090*	7 090*



Radius of Load - Expandable Undercarriage																	
11' 1" (3.38 m) Arm with 22' 11" (6.98 m) Boom and 3,200 lb. (1 460 kg) Bucket with Power-Boost Applied																	
End	Side	5' 0" (1.5 m)		10' 0" (3.0 m)		15' 0" (4.5 m)		20' 0" (6.0 m)		25' 0" (7.5 m)		30' 0" (9.0 m)		35' 0" (10.5 m)		Max. Reach	
		End	Side	End	Side	End	Side	End	Side	End	Side	End	Side	End	Side	End	Side
+30' 0"	lbs											14,200*	14,200*			12,900*	12,900*
(9.0 m)	kg											7 400*	7 400*			5 830*	5 830*
+25' 0"	lbs											18,200*	18,200*			12,400*	12,400*
(7.5 m)	kg											8 430*	8 430*			5 620*	5 620*
+20' 0"	lbs									21,350*	21,350*	19,900*	18,500	16,050*	13,800	12,300*	12,300*
(6.0 m)	kg									9 820*	9 820*	9 090*	8 600	8 090*	6 470	5 590*	5 590*
+15' 0"	lbs							28,950*	28,950*	23,850*	23,800*	20,750*	17,800	18,350*	13,500	12,550*	11,900
(4.5 m)	kg							13 450*	13 450*	11 030*	11 030*	9 540*	8 300	8 440*	6 310	5 690*	5 390
+10' 0"	lbs					45,200*	45,200*	33,800*	32,350	26,550*	22,950	22,200*	17,100	19,150*	13,100	13,000*	11,350
(3.0 m)	kg					20 890*	20 890*	15 690*	15 010	12 290*	10 670	10 260*	7 950	8 840*	6 110	5 920*	5 160
+5' 0"	lbs					50,250*	47,300	37,200*	30,650	28,650*	21,850	23,400*	16,400	19,650*	12,700	13,850*	11,250
(1.5 m)	kg					23 220*	21 960	17 230*	14 230	13 250*	10 150	10 810*	7 640	9 100*	5 930	6 300*	5 120
Ground Line	lbs			21,000*	21,000*	51,750*	45,400	38,350*	29,350	29,600*	21,000	23,800*	15,900	19,600*	12,450	15,150*	11,650
	kg			9 220*	9 220*	22 400*	21 040	17 740*	13 640	13 680*	9 770	11 020*	7 400	9 090*	5 810	6 870*	5 290
-5' 0"	lbs	22,850*	22,850*	33,100*	33,100*	51,600*	45,450*	37,900*	28,950	29,300*	20,650	23,400*	15,700			17,200*	12,600
(1.5 m)	kg	10 200*	10 200*	14 750*	14 750*	23 800*	21 050	17 530*	13 470	13 560*	9 610	10 850*	7 310			7 790*	5 710
-10' 0"	lbs	36,250*	36,250*	45,850*	45,850*	47,850*	45,850	35,950*	29,200	27,850*	20,850	21,450*	16,000			18,150*	14,350
(3.0 m)	kg	16 280*	16 280*	20 370*	20 370*	22 110*	21 330	16 650*	13 570	12 920*	9 680	10 040*	7 410			8 240*	6 490
-15' 0"	lbs			55,500*	55,500*	41,150*	41,150*	31,350*	29,450	23,700*	21,300					17,400*	17,400*
(4.5 m)	kg			25 750*	25 750*	19 110*	19 110*	14 620*	13 700	11 150*	9 890					7 950*	7 930*
-20' 0"	lbs					29,850*	29,850*	22,100*	22,100*							15,400*	15,400*
(6.0 m)	kg					14 140*	14 140*	10 630*	10 630*							7 090*	7 090*



LIFT CAPACITIES

Radius of Load - Fixed Undercarriage															
8' 4" (2.53 m) Arm with 22' 11" (6.98 m) Boom and 3,350 lb. (1 530 kg) Bucket with Power-Boost Applied															
 End	 Side	10' 0" (3.0 m)		15' 0" (4.5 m)		20' 0" (6.0 m)		25' 0" (7.5 m)		30' 0" (9.0 m)		35' 0" (10.5 m)		Max. Reach	
		End	Side	End	Side	End	Side	End	Side	End	Side	End	Side	End	Side
+30' 0"	lbs							18,500*	18,500*					18,100*	18,100*
(9.0 m)	kg							7 100*	7 100*					8 150*	8 150*
+25' 0"	lbs							21,600*	21,600*	20,100*	17,100			17,300*	16,100
(7.5 m)	kg							9 920*	9 920*	9 230*	7 990			7 830*	7 190
+20' 0"	lbs					26,500*	26,500*	23,800*	22,900*	21,100*	16,800			17,100*	13,700
(6.0 m)	kg					12 660*	12 660*	10 920*	10 610*	9 710*	7 820			7 760*	6 160
+15' 0"	lbs			40,800*	40,800*	32,050*	31,000	25,800*	21,950	22,500*	16,200			17,400*	12,400
(4.5 m)	kg			19 010*	19 010*	14 880*	14 380	11 940*	10 190	10 330*	7 540			7 890*	5 590
+10' 0"	lbs			48,550*	44,800	36,300*	29,300	28,150*	20,850	23,350*	15,600	20,000*	11,950	18,000*	11,750
(3.0 m)	kg			22 590*	20 710	16 840*	13 590	13 010*	9 680	10 780*	7 250	9 230*	5 580	8 170*	5 330
+5' 0"	lbs			40,000*	40,000*	38,500*	27,750	29,650*	19,950	24,100*	15,050	19,300*	11,700	19,050*	11,700
(1.5 m)	kg			16 780*	16 780*	17 810*	12 860	13 700*	9 250	11 120*	6 990	9 270*	5 460	8 660*	5 310
Ground Line	lbs			46,250*	41,150	38,550*	26,850	29,850*	19,300	24,000*	14,700			19,950*	12,200
	kg			20 000*	19 060	17 800*	12 470	13 790*	8 970	11 110*	6 830			9 040*	5 530
-5' 0"	lbs	35,900*	35,900*	49,500*	42,150	37,450*	26,900	29,100*	19,250	22,800*	14,750			19,700*	13,400
(1.5 m)	kg	16 100*	16 100*	22 790*	19 490	17 280*	12 500	13 470*	8 940	10 610*	6 850			8 940*	6 060
-10' 0"	lbs	52,900*	52,900*	44,150*	42,550	34,150*	27,400	26,300*	19,700					19,100*	15,700
(3.0 m)	kg	23 450*	23 450*	20 370*	19 760	15 800*	12 720	12 250*	9 120					8 650*	7 080
-15' 0"	lbs	44,200*	44,200*	35,450*	35,450*	27,400*	27,400*							17,350*	17,350*
(4.5 m)	kg	20 510*	20 510*	16 490*	16 490*	12 860*	12 760*							7 900*	7 900*

Radius of Load - Expandable Undercarriage															
8' 4" (2.53 m) Arm with 22' 11" (6.98 m) Boom and 3,350 lb. (1 530 kg) Bucket with Power-Boost Applied															
 End	 Side	10' 0" (3.0 m)		15' 0" (4.5 m)		20' 0" (6.0 m)		25' 0" (7.5 m)		30' 0" (9.0 m)		35' 0" (10.5 m)		Max. Reach	
		End	Side	End	Side	End	Side	End	Side	End	Side	End	Side	End	Side
+30' 0"	lbs							18,500*	18,500*					18,100*	18,100*
(9.0 m)	kg							7 100*	7 100*					8 150*	8 150*
+25' 0"	lbs							21,600*	21,600*	20,100*	18,450			17,300*	17,300*
(7.5 m)	kg							9 920*	9 920*	9 230*	8 610			7 830*	7 770
+20' 0"	lbs					26,500*	26,500*	23,800*	23,800*	21,100*	18,150			17,100*	14,850
(6.0 m)	kg					12 660*	12 660*	10 920*	10 920*	9 710*	8 440			7 760*	6 680
+15' 0"	lbs			40,800*	40,800*	32,050*	32,050*	25,800*	23,700	22,500*	17,550			17,400*	13,500
(4.5 m)	kg			19 010*	19 010*	14 880*	14 880*	11 940*	11 000	10 330*	8 160			7 890*	6 090
+10' 0"	lbs			48,550*	48,450	36,300*	31,750	28,150*	22,600	23,350*	16,900	20,000*	13,050	18,000*	12,850
(3.0 m)	kg			22 590*	22 510*	16 840*	14 730	13 010*	10 480	10 780*	7 870	9 230*	6 080	8 170*	5 820
+5' 0"	lbs			40,000*	40,000*	38,500*	30,150	29,650*	21,650	24,100*	16,400	19,300*	12,800	19,050*	12,800
(1.5 m)	kg			16 780*	16 780*	17 810*	13 990	13 700*	10 050	11 120*	7 610	9 270*	5 960	8 660*	5 800
Ground Line	lbs			46,250*	44,900	38,550*	29,250	29,850*	21,050	24,000*	16,050			19,950*	13,300
	kg			20 000*	20 000*	17 800*	13 590	13 790*	9 760	11 110*	7 440			9 040*	6 040
-5' 0"	lbs	35,900*	35,900*	49,500*	45,800	37,450*	29,300	29,100*	20,950	22,800*	16,100			19,700*	14,600
(1.5 m)	kg	16 100*	16 100*	22 790*	21 220	17 280*	13 610	13 470*	9 730	10 610*	7 460			8 940*	6 610
-10' 0"	lbs	52,900*	52,900*	44,150*	44,150*	34,150*	29,750	26,300*	21,400					19,100*	17,100
(3.0 m)	kg	23 450*	23 450*	20 370*	20 370*	15 800*	13 830	12 250*	9 910					8 650*	7 700
-15' 0"	lbs	44,200*	44,200*	35,450*	35,450*	27,400*	27,400*							17,350*	17,350*
(4.5 m)	kg	20 510*	20 510*	16 490*	16 490*	12 860*	12 860*							7 900*	7 900*

LIFT CAPACITIES

Radius of Load - Fixed Undercarriage																		
13' 2" (4.00 m) Arm with 22' 11" (6.98 m) Boom and 3,000 lb. (1 370 kg) Bucket with Power-Boost Applied																		
 End	 Side	5' 0" (1.5 m)		10' 0" (3.0 m)		15' 0" (4.5 m)		20' 0" (6.0 m)		25' 0" (7.5 m)		30' 0" (9.0 m)		35' 0" (10.5 m)		Max. Reach		
		End	Side	End	Side	End	Side	End	Side	End	Side	End	Side	End	Side	End	Side	
+30' 0"	lbs												13,750*	13,750*			10,350*	10,350*
(9.0 m)	kg												6 330*	6 330*			4 660*	4 660*
+25' 0"	lbs												16,950*	16,950*	12,150*	12,150*	9,950*	9,950*
(7.5 m)	kg											7 910*	7 910*	6 240*	6 240*	4 500*	4 500*	
+20' 0"	lbs												18,800*	17,700*	16,350*	13,250	9,900*	9,900*
(6.0 m)	kg											8 590*	8 200*	7 700*	6 210	4 490*	4 490*	
+15' 0"	lbs							23,450*	23,450*	22,700*	22,700*	19,900*	17,050	17,750*	12,900	10,100*	10,100*	
(4.5 m)	kg							11 460*	11 460*	10 480*	10 480*	9 130*	7 940	8 170*	6 020	4 580*	4 580*	
+10' 0"	lbs			40,000*	40,000*	44,800*	44,800*	32,200*	30,950*	25,650*	21,950	21,700*	16,300	18,850*	12,450	10,500*	9,850	
(3.0 m)	kg			15 690*	15 690*	20 720*	20 720*	14 940*	14 340	11 860*	10 190	10 000*	7 580	8 680*	5 800	4 760*	4 460	
+5' 0"	lbs			17,800*	17,800*	49,900*	45,000	36,350*	29,150	28,150*	20,750	23,150*	15,550	19,650*	12,000	11,200*	9,750	
(1.5 m)	kg			7 640*	7 640*	22 910*	20 900	16 830*	13 530	13 020*	9 630	10 690*	7 230	9 070*	5 590	5 070*	4 420	
Ground Line	lbs			23,800*	23,800*	52,350*	42,600	38,450*	27,650	29,650*	19,800	24,000*	14,950	19,900*	11,650	12,250*	10,000	
	kg			10 520*	10 520*	24 120*	19 820	17 780*	12 840	13 700*	9 200	11 080*	6 960	9 210*	5 430	5 550*	4 530	
-5' 0"	lbs	22,400*	22,400*	32,000*	32,000*	52,950*	42,050	38,500*	26,900	29,800*	19,250	23,900*	14,600	19,450*	11,500	13,850*	10,700	
(1.5 m)	kg	10 040*	10 040*	14 250*	14 250*	24 370*	19 580	17 790*	12 500	13 770*	8 950	11 070*	6 800	9 040*	5 360	6 260*	4 850	
-10' 0"	lbs	32,600*	32,600*	42,300*	42,300*	50,400*	42,350	37,350*	26,950	28,950*	19,250	22,850*	14,650			16,400*	12,050	
(3.0 m)	kg	14 650*	14 650*	18 800*	18 800*	23 290*	19 720	17 280*	12 510	13 400*	8 940	10 620*	6 810			7 400*	5 430	
-15' 0"	lbs	42,550*	42,550*	56,350*	56,350*	45,050*	42,600	33,950*	27,400	26,100*	19,650	19,150*	15,150			17,600*	14,450	
(4.5 m)	kg	19 010*	19 010*	25 410*	25 410*	20 880*	19 820	15 770*	12 730	12 180*	9 120	9 140*	7 050			7 970*	6 480	
-20' 0"	lbs			48,350*	48,350*	35,800*	35,800*	27,000*	27,000*	19,000*	19,000*					16,600*	16,600*	
(6.0 m)	kg			22 690*	22 690*	16 790*	16 790*	12 740*	12 710	9 240*	9 170					7 550*	7 550*	

Radius of Load - Expandable Undercarriage																		
13' 2" (4.00 m) Arm with 22' 11" (6.98 m) Boom and 3,000 lb. (1 370 kg) Bucket with Power-Boost Applied																		
 End	 Side	5' 0" (1.5 m)		10' 0" (3.0 m)		15' 0" (4.5 m)		20' 0" (6.0 m)		25' 0" (7.5 m)		30' 0" (9.0 m)		35' 0" (10.5 m)		Max. Reach		
		End	Side	End	Side	End	Side	End	Side	End	Side	End	Side	End	Side	End	Side	
+30' 0"	lbs												13,750*	13,750*			10,350*	10,350*
(9.0 m)	kg												6 330*	6 330*			4 660*	4 660*
+25' 0"	lbs												16,950*	16,950*	12,150*	12,150*	9,950*	9,950*
(7.5 m)	kg											7 910*	7 910*	6 240*	6 240*	4 500*	4 500*	
+20' 0"	lbs												18,800*	18,550	16,350*	14,350	9,900*	9,900*
(6.0 m)	kg											8 590*	8 590*	7 700*	6 710	4 490*	4 490*	
+15' 0"	lbs							23,450*	23,450*	22,700*	22,700*	19,900*	18,400	17,750*	14,000	10,100*	10,100*	
(4.5 m)	kg							11 460*	11 460*	10 480*	10 480*	9 130*	8 560	8 170*	6 520	4 580*	4 580*	
+10' 0"	lbs			40,000*	40,000*	44,800*	44,800*	32,200*	32,200*	25,650*	23,700	21,700*	17,600	18,850*	13,550	10,500*	10,500*	
(3.0 m)	kg			15 690*	15 690*	20 720*	20 720*	14 940*	14 940*	11 860*	11 000	10 000*	8 200	8 680*	6 310	4 760*	4 760*	
+5' 0"	lbs			17,800*	17,800*	49,900*	48,950	36,350*	31,600	28,150*	22,450	23,150*	16,900	19,650*	13,100	11,200*	10,650	
(1.5 m)	kg			7 640*	7 640*	22 910*	22 730	16 830*	14 660	13 020*	10 440	10 690*	7 850	9 070*	6 100	5 070*	4 840	
Ground Line	lbs			23,800*	23,800*	52,350*	46,600	38,450*	30,050	29,650*	21,500	24,000*	16,300	19,900*	12,750	12,250*	10,950	
	kg			10 520*	10 520*	24 120*	21 640	17 780*	13 960	13 700*	10 000	11 080*	7 570	9 210*	5 930	5 550*	4 970	
-5' 0"	lbs	22,400*	22,400*	32,000*	32,000*	52,950*	46,000	38,500*	29,300	29,800*	20,950	23,900*	15,950	19,450*	12,600	13,850*	11,700	
(1.5 m)	kg	10 040*	10 040*	14 250*	14 250*	24 370*	21 290	17 790*	13 610	13 770*	9 740	11 070*	7 410	9 040*	5 860	6 260*	5 310	
-10' 0"	lbs	32,600*	32,600*	42,300*	42,300*	50,400*	46,300	37,350*	29,300	28,950*	20,950	22,850*	16,000			16,400*	13,150	
(3.0 m)	kg	14 650*	14 650*	18 800*	18 800*	23 290*	21 550	17 280*	13 620	13 400*	9 730	10 620*	7 430			7 400*	5 940	
-15' 0"	lbs	42,550*	42,550*	56,350*	56,350*	45,050*	45,050*	33,950*	29,800	26,100*	21,350	19,150*	16,500			17,600*	15,750	
(4.5 m)	kg	19 010*	19 010*	25 410*	25 410*	20 880*	20 880*	15 770*	13 840	12 180*	9 910	9 140*	7 650			7 970*	7 060	
-20' 0"	lbs			48,350*	48,350*	35,800*	35,800*	27,000*	27,000*	19,000*	19,000*					16,600*	16,600*	
(6.0 m)	kg			22 690*	22 690*	16 790*	16 790*	12 740*	12 740*	9 240*	9 240*					7 550*	7 550*	

LIFT CAPACITIES

Radius of Load - Fixed Undercarriage																				
15' 11" (4.85 m) Arm with 22' 11" (6.98 m) Boom and 2,800 lb. (1 260 kg) Bucket with Power-Boost Applied																				
End	Side	5' 0" (1.5 m)		10' 0" (3.0 m)		15' 0" (4.5 m)		20' 0" (6.0 m)		25' 0" (7.5 m)		30' 0" (9.0 m)		35' 0" (10.5 m)		40' 0" (12.0 m)		Max. Reach		
		End	Side	End	Side	End	Side	End	Side	End	Side	End	Side	End	Side	End	Side	End	Side	
+30' 0"	lbs														10,600*	10,600*			9,300*	9,300*
(9.0 m)	kg														5 380*	5 380*			4 200*	4 200*
+25' 0"	lbs														13,800*	13,800*			9,000*	9,000*
(7.5 m)	kg														6 480*	6 480*			4 090*	4 090*
+20' 0"	lbs												16,700*	16,700*	15,200*	13,650*	10,050*	10,050*	9,000*	9,000*
(6.0 m)	kg												7 640*	7 640*	7 030*	6 390	5 250*	4 830	4 080*	4 080*
+15' 0"	lbs												18,000*	17,500	16,700*	13,200	12,850*	10,050	9,150*	9,150*
(4.5 m)	kg												8 270*	8 110*	7 710*	6 160	6 330*	4 720	4 170*	4 170*
+10' 0"	lbs					38,350*	38,350*	29,000*	29,000*	23,600*	22,450	20,100*	16,600	17,700*	12,650	14,550*	9,750	9,550*	8,800	8,800
(3.0 m)	kg					17 590*	17 590*	13 440*	13 440*	10 910*	10 420	9 280*	8 130*	7 730	5 890	7 120*	4 560	4 330*	3 980	3 980
+5' 0"	lbs			29,600*	29,600*	47,600*	45,850	33,850*	29,850	26,500*	21,100	21,950*	15,750	18,800*	12,100	15,400*	9,450	10,150*	8,650	8,650
(1.5 m)	kg			12 670*	12 670*	22 070*	21 270	15 660*	13 860	12 240*	9 810	10 140*	7 320	8 670*	5 630	7 580*	4 410	4 610*	3 930	3 930
Ground Line	lbs			25,900*	25,900*	50,950*	43,100	37,000*	27,900	28,550*	19,900	23,250*	15,000	19,500*	11,600	14,450*	9,200	11,050*	8,850	8,850
	kg			11 450*	11 450*	23 370*	20 040	17 110*	12 960	13 190*	9 260	10 730*	6 970	9 010*	5 410	7 450*	4 290	5 010*	4 000	4 000
-5' 0"	lbs	20,850*	20,850*	31,000*	31,000*	52,500*	41,400	38,150*	26,650	29,400*	19,100	23,650*	14,450	19,500*	11,300			12,400*	9,350	9,350
(1.5 m)	kg	9 340*	9 340*	13 800*	13 800*	24 140*	19 270	17 610*	12 390	13 590*	8 880	10 940*	6 720	9 040*	5 270			5 610*	4 230	4 230
-10' 0"	lbs	28,700*	28,700*	39,000*	39,000*	51,550*	41,350	37,600*	26,350	29,050*	18,800	23,250*	14,300	18,650*	11,300			14,450*	10,350	10,350
(3.0 m)	kg	12 870*	12 870*	17 310*	17 310*	23 810*	19 240	17 390*	12 250	13 440*	8 750	10 770*	6 640	8 710*	5 250			6 520*	4 670	4 670
-15' 0"	lbs	38,500*	38,500*	50,750*	50,750*	48,000*	41,850	35,600*	26,600	27,500*	19,050	21,450*	14,550					16,700*	12,050	12,050
(4.5 m)	kg	17 130*	17 130*	22 380*	22 380*	22 220*	19 470	16 500*	12 360	12 780*	8 830	10 040*	6 740					7 570*	5 420	5 420
-20' 0"	lbs	48,850*	48,850*	58,200*	58,200*	41,150*	41,150*	30,900*	27,250	23,400*	19,650							16,500*	15,250	15,250
(6.0 m)	kg	21 770*	21 770*	27 160*	27 160*	19 200*	19 200*	14 440*	12 660	11 020*	9 130							7 480*	6 790	6 790
-25' 0"	lbs			39,900*	39,900*	29,300*	29,300*	21,400*	21,400*									15,150*	15,150*	15,150*
(7.5 m)	kg			19 100*	19 100*	14 040*	14 040*	10 390*	10 390*									6 910*	6 910*	6 910*

Radius of Load - Expandable Undercarriage																				
15' 11" (4.85 m) Arm with 22' 11" (6.98 m) Boom and 2,800 lb. (1 260 kg) Bucket with Power-Boost Applied																				
End	Side	5' 0" (1.5 m)		10' 0" (3.0 m)		15' 0" (4.5 m)		20' 0" (6.0 m)		25' 0" (7.5 m)		30' 0" (9.0 m)		35' 0" (10.5 m)		40' 0" (12.0 m)		Max. Reach		
		End	Side	End	Side	End	Side	End	Side	End	Side	End	Side	End	Side	End	Side	End	Side	
+30' 0"	lbs														10,600*	10,600*			9,300*	9,300*
(9.0 m)	kg														5 380*	5 380*			4 200*	4 200*
+25' 0"	lbs														13,800*	13,800*			9,000*	9,000*
(7.5 m)	kg														6 480*	6 480*			4 090*	4 090*
+20' 0"	lbs												16,700*	16,700*	15,200*	14,750	10,050*	10,050*	9,000*	9,000*
(6.0 m)	kg												7 640*	7 640*	7 030*	6 890	5 250*	5 250	4 080*	4 080*
+15' 0"	lbs												18,000*	18,000*	16,700*	14,300	12,850*	11,000	9,150*	9,150*
(4.5 m)	kg												8 270*	8 270*	7 710*	6 670	6 330*	5 140	4 170*	4 170*
+10' 0"	lbs					38,350*	38,350*	29,000*	29,000*	23,600*	23,600*	20,100*	17,950	17,700*	13,750	14,550*	10,650	9,550*	9,550*	9,550*
(3.0 m)	kg					17 590*	17 590*	13 440*	13 440*	10 910*	10 910*	9 280*	8 360	8 130*	6 400	7 120*	4 990	4 330*	4 330*	4 330*
+5' 0"	lbs			29,600*	29,600*	47,600*	47,600*	33,850*	32,150*	26,500*	22,850	21,950*	17,100	18,800*	13,200	15,400*	10,350	10,150*	9,550	9,550
(1.5 m)	kg			12 670*	12 670*	22 070*	22 070*	15 660*	14 910	12 240*	10 610	10 140*	7 940	8 670*	6 140	7 580*	4 840	4 610*	4 320	4 320
Ground Line	lbs			25,900*	25,900*	50,950*	47,100	37,000*	30,350	28,550*	21,650	23,250*	16,300	19,500*	12,700	14,450*	10,100	11,050*	9,700	9,700
	kg			11 450*	11 450*	23 370*	21 900	17 110*	14 090	13 190*	10 060	10 730*	7 590	9 010*	5 920	7 450*	4 710	5 010*	4 410	4 410
-5' 0"	lbs	20,850*	20,850*	31,000*	31,000*	52,500*	45,350	38,150*	29,050	29,400*	20,800	23,650*	15,800	19,500*	12,400			12,400*	10,250	10,250
(1.5 m)	kg	9 340*	9 340*	13 800*	13 800*	24 140*	21 110	17 610*	13 510	13 590*	9 670	10 940*	7 340	9 040*	5 770			5 610*	4 650	4 650
-10' 0"	lbs	28,700*	28,700*	39,000*	39,000*	51,550*	45,250	37,600*	28,750	29,050*	20,550	23,250*	15,600	18,650*	12,400			14,450*	11,350	11,350
(3.0 m)	kg	12 870*	12 870*	17 310*	17 310*	23 810*	21 060	17 390*	13 350	13 440*	9 540	10 770*	7 250	8 710*	5 750			6 520*	5 120	5 120
-15' 0"	lbs	38,500*	38,500*	50,750*	50,750*	48,000*	45,550*	35,600*	29,000	27,500*	20,750	21,450*	15,900					16,700*	13,200	13,200
(4.5 m)	kg	17 130*	17 130*	22 380*	22 380*	22 220*	21 180*	16 500*	13 470	12 780*	9 620	10 040*	7 360					7 570*	5 930	5 930
-20' 0"	lbs	48,850*	48,850*	58,200*	58,200*	41,150*	41,150*	30,900*	29,250	23,400*	21,150							16,500*	16,500*	16,500*
(6.0 m)	kg	21 770*	21 770*	27 160*	27 160*	19 200*	19 200*	14 440*	13 590	11 020*	9 820*							7 480*	7 400	7 400
-25' 0"	lbs			39,900*	39,900*	29,300*	29,300*	21,400*	21,400*									15,150*	15,150*	15,150*
(7.5 m)	kg			19 100*	19 100*	14 040*	14 040*	10 390*	10 390*									6 910*	6 910*	6 910*

Notes: Excavator lifting capacities

- Lifting capacities shown should not be exceeded. Weight of all lifting accessories must be deducted from the above lifting capacities.
- Lifting capacities are based on machine standing on firm, uniform supporting surface. User must make allowances for job conditions such as soft or uneven ground.
- Lifting capacities shown do not exceed 75% of minimum tipping loads or 87% of hydraulic capacities. **Capacities marked with an asterisk (*) are limited by hydraulic capacities.**
- Least stable position is over the side.
- Operator should be fully acquainted with the Operator's Manual & Operating Safety Booklet, furnished by LBX before operating the machine.
- Capacities apply only to the machine as originally manufactured and normally equipped by LBX Company, LLC.
- Lift capacity ratings are based on ISO 10567, "Earthmoving Machinery - Hydraulic Excavators - Lift Capacity."

LIFT CAPACITIES

Radius of Load - Mass Excavator - Fixed Undercarriage													
8' 4" (2.53 m) Arm with 21' 6" (6.55 m) Boom and 5,300 lb. (2 400 kg) Bucket with Power-Boost Applied													
End	Side	10' 0" (3.0 m)		15' 0" (4.5 m)		20' 0" (6.0 m)		25' 0" (7.5 m)		30' 0" (9.0 m)		Max. Reach	
		End	Side	End	Side	End	Side	End	Side	End	Side	End	Side
+30' 0"	lbs							19,150*	19,150*			15,250*	15,250*
(9.0 m)	kg							7 660*	7 660*			6 840*	6 840*
+25' 0"	lbs							20,200*	20,200*			14,350*	14,350*
(7.5 m)	kg							9 260*	9 260*			6 490*	6 490*
+20' 0"	lbs					21,550*	21,550*	22,200*	21,900*	19,800*	15,700	14,150*	13,200
(6.0 m)	kg					9 920*	9 920*	10 260*	10 160*	9 090*	7 350	6 410*	5 950
+15' 0"	lbs			37,850*	37,850*	30,100*	30,100*	24,600*	21,300	21,000*	15,250	14,250*	11,800
(4.5 m)	kg			17 560*	17 560*	13 980*	13 980*	11 360*	9 920	9 690*	7 110	6 460*	5 340
+10' 0"	lbs			45,550*	45,550*	34,500*	29,150	26,850*	20,200	22,200*	14,650	14,750*	11,150
(3.0 m)	kg			21 130*	21 130*	16 000*	13 530	12 410*	9 400	10 250*	6 830	6 690*	5 050
+5' 0"	lbs			50,950*	42,600	37,200*	27,350	28,350*	19,200	22,750*	14,100	15,700*	11,050
(1.5 m)	kg			23 500*	19 780	17 210*	12 700	13 120*	8 930	10 520*	6 570	7 140*	5 020
Ground	lbs	25,350*	25,350*	51,850*	41,250	37,450*	26,250	28,600*	18,500	22,650*	13,700	17,400*	11,600
Line	kg	11 400*	11 400*	23 890*	19 170	17 310*	12 210	13 230*	8 610	10 500*	6 380	7 880*	5 260
-5' 0"	lbs	38,650*	38,650*	49,350*	41,950	36,400*	26,150	27,800*	18,300	21,050*	13,750	18,850*	12,900
(1.5 m)	kg	17 160*	17 160*	22 760*	19 560	16 830*	12 160	12 880*	8 510	9 860*	6 380	8 530*	5 830
-10' 0"	lbs	57,400*	57,400*	43,800*	41,850	32,900*	26,600	24,500*	18,800			18,100*	15,400
(3.0 m)	kg	25 350*	25 350*	20 250*	19 470	15 260*	12 360	11 470*	8 720			8 220*	6 940
-15' 0"	lbs	44,250*	44,250*	34,050*	34,050*	25,150*	25,150*					16,050*	16,050*
(4.5 m)	kg	20 640*	20 640*	15 920*	15 920*	11 890*	11 890*					7 320*	7 320*

Radius of Load - Mass Excavator - Expandable Undercarriage													
8' 4" (2.53 m) Arm with 21' 6" (6.55 m) Boom and 5,300 lb. (2 400 kg) Bucket with Power-Boost Applied													
End	Side	10' 0" (3.0 m)		15' 0" (4.5 m)		20' 0" (6.0 m)		25' 0" (7.5 m)		30' 0" (9.0 m)		Max. Reach	
		End	Side	End	Side	End	Side	End	Side	End	Side	End	Side
+30' 0"	lbs							19,150*	19,150*			15,250*	15,250*
(9.0 m)	kg							7 660*	7 660*			6 840*	6 840*
+25' 0"	lbs							20,200*	20,200*			14,350*	14,350*
(7.5 m)	kg							9 260*	9 260*			6 490*	6 490*
+20' 0"	lbs					21,550*	21,550*	22,200*	22,200*	19,800*	17,050	14,150*	14,150*
(6.0 m)	kg					9 920*	9 920*	10 260*	10 260*	9 090*	7 970	6 410*	6 410*
+15' 0"	lbs			37,850*	37,850*	30,100*	30,100*	24,600*	23,050	21,000*	16,600	14,250*	12,950
(4.5 m)	kg			17 560*	17 560*	13 980*	13 980*	11 360*	10 730	9 690*	7 740	6 460*	5 860
+10' 0"	lbs			45,550*	45,550*	34,500*	31,600	26,850*	21,950	22,200*	16,000	14,750*	12,250
(3.0 m)	kg			21 130*	21 130*	16 000*	14 680	12 410*	10 210	10 250*	7 450	6 690*	5 550
+5' 0"	lbs			50,950*	46,600	37,200*	29,800	28,350*	20,950	22,750*	15,400	15,700*	12,200
(1.5 m)	kg			23 500*	21 650	17 210*	13 840	13 120*	9 740	10 520*	7 190	7 140*	5 530
Ground	lbs	25,350*	25,350*	51,850*	45,150	37,450*	28,700	28,600*	20,250	22,650*	15,050	17,400*	12,750
Line	kg	11 400*	11 400*	23 890*	20 990	17 310*	13 340	13 230*	9 410	10 500*	7 000	7 880*	5 790
-5' 0"	lbs	38,650*	38,650*	49,350*	45,750*	36,400*	28,550	27,800*	20,000	21,050*	15,100	18,850*	14,150
(1.5 m)	kg	17 160*	17 160*	22 760*	21 300	16 830*	13 280	12 880*	9 310	9 860*	7 000	8 530*	6 400
-10' 0"	lbs	57,400*	57,400*	43,800*	43,800*	32,900*	28,950	24,500*	20,450			18,100*	16,850
(3.0 m)	kg	25 350*	25 350*	20 250*	20 250*	15 260*	13 470	11 470*	9 510			8 220*	7 600
-15' 0"	lbs	44,250*	44,250*	34,050*	34,050*	25,150*	25,150*					16,050*	16,050*
(4.5 m)	kg	20 640*	20 640*	15 920*	15 920*	11 890*	11 890*					7 320*	7 320*

Bucket Sizes for Mass Excavators

490 X4 Mass with Fixed Sideframe

Bucket Type	Heaped Capacity (yd ³) (m ³)	Width Outside Lip (in) (mm)	Bucket Weight (lbs) (kg)	Number of Teeth	Arm 8' 4" 2.53 m			
STDP Standard duty plate	1.76	1.35	36	914	2906	1318	4	H
	2.14	1.64	42	1067	3206	1454	5	H
	2.52	1.93	48	1219	3405	1545	5	H
	2.91	2.22	54	1372	3705	1681	6	H
	3.29	2.52	60	1524	3903	1770	6	H
4.05	3.10	66	1676	4698	2131	7	M	
HDP Heavy duty plate	1.73	1.32	36	914	3507	1591	4	H
	2.10	1.61	42	1067	3848	1745	5	H
	2.48	1.90	48	1219	4108	1863	5	H
	2.85	2.18	54	1372	4448	2018	6	H
	3.24	2.48	60	1524	4707	2135	6	H
XDP Extreme duty plate	1.37	1.05	30	762	3469	1574	3	H
	1.73	1.32	36	914	3838	1741	4	H
	2.1	1.61	42	1067	4144	1880	4	H
	2.48	1.90	48	1219	4485	2034	5	H
	Power Buckets	1.64	1.25	36	914	5460	2477	4
	1.97	1.51	42	1067	5829	2644	5	H
	2.31	1.77	48	1219	6120	2776	5	H
	2.65	2.03	54	1372	6489	2943	6	H
	2.99	2.29	60	1524	6780	3075	6	H

490 X4 Mass with Expandable Sideframe

Bucket Type	Heaped Capacity (yd ³) (m ³)	Width Outside Lip (in) (mm)	Bucket Weight (lbs) (kg)	Number of Teeth	Arm 8' 4" 2.53 m			
STDP Standard duty plate	1.76	1.35	36	914	2906	1318	4	H
	2.14	1.64	42	1067	3206	1454	5	H
	2.52	1.93	48	1219	3405	1545	5	H
	2.91	2.22	54	1372	3705	1681	6	H
	3.29	2.52	60	1524	3903	1770	6	H
4.05	3.10	66	1676	4698	2131	7	M	
HDP Heavy duty plate	1.73	1.32	36	914	3507	1591	4	H
	2.10	1.61	42	1067	3848	1745	5	H
	2.48	1.90	48	1219	4108	1863	5	H
	2.85	2.18	54	1372	4448	2018	6	H
	3.24	2.48	60	1524	4707	2135	6	H
XDP Extreme duty plate	1.37	1.05	30	762	3469	1574	3	H
	1.73	1.32	36	914	3838	1741	4	H
	2.1	1.61	42	1067	4144	1880	4	H
	2.48	1.90	48	1219	4485	2034	5	H
	Power Buckets	1.64	1.25	36	914	5460	2477	4
	1.97	1.51	42	1067	5829	2644	5	H
	2.31	1.77	48	1219	6120	2776	5	H
	2.65	2.03	54	1372	6489	2943	6	H
	2.99	2.29	60	1524	6780	3075	6	H

Approval Code For Arm/Bucket Combinations

H..... Heavy material
(up to 3,370 lbs./yd³)

M..... Medium material
(up to 2,700 lbs./yd³)

L..... Light material
(up to 2,020 lbs./yd³)

N/A..... Not applicable

STDP - Standard duty plate
HDP - Heavy duty plate
XDP - Extreme duty plate
POWER - HDP for use with ESCO multi-pin grabber only

STANDARD & OPTIONAL EQUIPMENT

STANDARD EQUIPMENT

CAB

- 12V Power Outlet
- AM/ FM Sound System
- Anti-Theft Device
- Auxiliary Switches on Control Lever
- Bluetooth
- Cab Filter - External
- Cab Handrails
- Cab Interior Light
- Cab ISO-Mounts
- Cab Light (2)
- Clear Roof Window
- Climate Control A/C and Heater
- Cup Holder
- Defroster
- Digital Clock
- Emergency Exit and Hammer
- Face Vent
- Floor Mat
- FOPS Level 1 Certified
- Front Window One-Touch Lock
- Gate Lock Hydraulic Activation
- Horn
- Hour Meter (Digital)
- LCD Color Monitor
- Magazine Storage Rack
- Maintenance Interval Reminders
- MP3 Auxiliary Input Jack
- On-Board Diagnostic System
- One-Piece Right Window
- Radio Mute Switch
- Rear View Camera
- Rear View Mirrors (2)
- RemoteCARE Support System (GPS)
- Roof Sun Shade
- ROPS Certified Structure
- Safety Glass Windows
- SCM Air-Suspension Seat
- Seat Recline
- Selectable Monitor Languages
- Small Storage
- Travel Alarm with Cancel Switch
- Trip Meter (Digital)
- USB Input
- Wiper & Washer
- Wiper Switch on RH Joystick

ENGINE

- 50A Alternator
- Air Filter (Double Element)
- Air Filter Restriction Indicator
- Air Pre-Cleaner (Cyclone type)

- Auto Warm-Up System
- Auto-Idle
- Auto-Idle Engine Shutdown
- Battery Disconnect Switch
- Cooling Fan
- Diesel Oxidation Catalyst (DOC)
- Drain for Fuel Tank
- Dual Remote Fuel Filters with Water Separators
- EGR Coolers
- Emergency Engine Stop
- Engine Idle System
- Engine Oil Sample Port
- Engine Protection Feature
- External Fuel Gauge
- External DEF Gauge
- Fan Housing
- Fuel Cooler
- Fuel Filter Restriction Indicator
- Fuel Management System
- Fuel Shut-Off Valve
- Fuel Usage History
- Fuel Usage Monitor
- Glow Plug Pre-Heat
- Idle-Start
- Intercooler
- Neutral Start
- One-Touch Idle
- Passive Emissions Regeneration
- Radiator / Oil Cooler / Intercooler Protective Screen
- Remote Engine Oil Drain
- Remote Oil Filter
- Reversible Cooling Fan
- Selective Catalytic Reduction (SCR)
- Tropical Package
- DEF Gauge on Monitor
- VGT Turbocharger

HYDRAULICS

- Anti-Drift Valves
- Arm Regeneration
- Arm Speed Assistance (2 Pump Flow)
- Attachment Cushion Valve
- Auto Swing Priority
- Auxiliary Flow Control
- Auxiliary Tool Settings (Memory)
- Auxiliary Valve
- Boom Regeneration
- Boom Speed Assistance (2 Pump Flow)
- Bucket Curl Assist
- Control Levers Pre-Wired for Auxiliary Hyd.

- Control Pattern Changer (2 way)
- Electronically Controlled Hydraulic Pumps
- Fire Wall
- Free Swing
- Hydraulic Filter Restriction Indicator
- Hydraulic Oil Sample Port
- Long Life Hydraulic Oil (5,000 Hour)
- Neutral Pump De-Stroke
- Oil Cooler
- Power Boost
- Power Save
- Pressure Reading on Monitor
- Pump Stand-By Pressure
- Single Pedal Travel
- Straight Travel Circuit

UNDERCARRIAGE

- 900 mm (35.5") 3-Bar Steel Grousers
- Carbody Belly Pan (Swivel Guarding)
- Center Track Guide (double)
- Lashing Points (Tie-Downs)
- Long Undercarriage
- Sealed Link Chain
- Steps
- Strutted Track Chain
- X-Pattern Carbody

UPPERSTRUCTURE

- Belly Pans
- Catwalks
- Center Cover (Over Main CV)
- Fuel Tank Belly Pan
- Hand Rail (RH access)
- ISO Guard Rails
- Lifting Eyes for Counterweight
- Lockable Fuel Cap and Service Doors
- Lockable Tool Box
- Turntable Tub
- Work Lights (Boom and Tool Box)

ATTACHMENT

- 11' 1" (3.38 m) Arm
- 22' 11" (6.98 m) Main Boom Section
- Auxiliary Pipe Brackets
- Boom Work Light (2)
- Bucket Anti-Clatter Device
- Chrome Pins
- Easy Maintenance System (EMS)
- HD Bucket Linkage
- Remote Lube Bank
- Teardrop Pin Retention Keepers

OPTIONAL EQUIPMENT

CAB

- 270° WAVES™ Camera System
- Cab Light (2 LED)
- Cab Sun Screen (rear)
- FOPS Head Guard (Level 2)
- Front Guard (Mesh)
- Front Guard (OPG 1,2)
- LED Light Kit for Side Camera (1)
- LED Lights for Rear Camera (2)
- Rain Deflector
- SCM Air-Suspension Seat w/ Tilt & Heater

ENGINE

- Refuel Pump

HYDRAULICS

- Hose Burst Check Valve
- Proportional Hydraulic Controls

AUXILIARY HYDRAULIC OPTIONS

- Single-Acting Aux. w/ Proportional Joysticks
- Multi-Function Aux. w/ in-cab pressure setting control
- Thumb Aux. w/ Proportional Joysticks
- Combination Aux. w/ in-cab pressure setting control

UNDERCARRIAGE

- 750 mm (29.5") 3-Bar Steel Grousers
- Full Length Track Guide

UPPERSTRUCTURE

- Counterweight Removal System

ATTACHMENT

- 8' 4" (2.53 m) Arm
- 13' 2" (4.00 m) Arm
- 15' 11" (4.85 m) Arm
- 21' 6" (6.55 m) Mass Boom Section
- Quick Couplers
- Thumbs

Bucket Sizes

490 X4 with Fixed Sideframe

Bucket Type	Heaped Capacity		Width Outside Lip		Bucket Weight (kg)	Number of Teeth	Arm 8' 4" 2.53 m	Arm 11' 1" 3.38 m	Arm 13' 2" 2.94 m	Arm 15' 11" 4.85 m	
	(yd³)	(m³)	(in)	(mm)							
STDP Standard duty plate	1.76	1.35	36	914	2,906	1,318	4	H	H	H	H
	2.14	1.64	42	1,067	3,206	1,454	5	H	H	H	H
	2.52	1.93	48	1,219	3,405	1,545	5	H	H	H	M
	2.91	2.22	54	1,372	3,705	1,681	6	H	H	M	L
	3.29	2.52	60	1,524	3,903	1,770	6	H	M	M	L
	4.05	3.10	66	1,676	4,698	2,131	7	M	L	L	N/A
HDP Heavy duty plate	1.73	1.32	36	914	3,507	1,591	4	H	H	H	H
	2.10	1.61	42	1,067	3,848	1,745	5	H	H	H	H
	2.48	1.90	48	1,219	4,108	1,863	5	H	H	H	M
	2.85	2.18	54	1,372	4,448	2,018	6	H	M	M	L
	3.24	2.48	60	1,524	4,707	2,135	6	H	M	M	L
XDP Extreme duty plate	1.37	1.05	30	762	3,469	1,574	3	H	H	H	H
	1.73	1.32	36	914	3,838	1,741	4	H	H	H	H
	2.1	1.61	42	1,067	4,144	1,880	4	H	H	H	H
	2.48	1.90	48	1,219	4,485	2,034	5	H	H	H	M
	Power Buckets	1.64	1.25	36	914	5,460	2,477	4	H	H	H
1.97		1.51	42	1,067	5,829	2,644	5	H	H	H	M
2.31		1.77	48	1,219	6,120	2,776	5	H	M	L	L
2.65		2.03	54	1,372	6,489	2,943	6	H	M	M	L
2.99		2.29	60	1,524	6,780	3,075	6	M	L	L	N/A

490 X4 with Expandable Sideframe

Bucket Type	Heaped Capacity		Width Outside Lip		Bucket Weight (kg)	Number of Teeth	Arm 8' 4" 2.53 m	Arm 11' 1" 3.38 m	Arm 13' 2" 2.94 m	Arm 15' 11" 4.85 m	
	(yd³)	(m³)	(in)	(mm)							
STDP Standard duty plate	1.76	1.35	36	914	2,906	1,318	4	H	H	H	H
	2.14	1.64	42	1,067	3,206	1,454	5	H	H	H	H
	2.52	1.93	48	1,219	3,405	1,545	5	H	H	H	M
	2.91	2.22	54	1,372	3,705	1,681	6	H	H	M	L
	3.29	2.52	60	1,524	3,903	1,770	6	H	M	M	L
	4.05	3.10	66	1,676	4,698	2,131	7	M	L	L	N/A
HDP Heavy duty plate	1.73	1.32	36	914	3,507	1,591	4	H	H	H	H
	2.10	1.61	42	1,067	3,848	1,745	5	H	H	H	H
	2.48	1.90	48	1,219	4,108	1,863	5	H	H	H	M
	2.85	2.18	54	1,372	4,448	2,018	6	H	M	M	L
	3.24	2.48	60	1,524	4,707	2,135	6	H	M	M	L
XDP Extreme duty plate	1.37	1.05	30	762	3,469	1,574	3	H	H	H	H
	1.73	1.32	36	914	3,838	1,741	4	H	H	H	H
	2.1	1.61	42	1,067	4,144	1,880	4	H	H	H	H
	2.48	1.90	48	1,219	4,485	2,034	5	H	H	H	M
	Power Buckets	1.64	1.25	36	914	5,460	2,477	4	H	H	H
1.97		1.51	42	1,067	5,829	2,644	5	H	H	H	M
2.31		1.77	48	1,219	6,120	2,776	5	H	M	L	L
2.65		2.03	54	1,372	6,489	2,943	6	H	M	M	L
2.99		2.29	60	1,524	6,780	3,075	6	H	M	M	L

Litho in USA 10/17 #LBX2359 supersedes LBX2300

LBX® and Link-Belt® are registered trademarks. Copyright 2017. All rights reserved. We are constantly improving our products and therefore reserve the right to change designs and specifications.