

Hiab XS 377 R

Capacity 36 tm



Hiab XS 377 R Basic data

Technical data

	EP-2 Duo	EP-3 Duo	EP-2 HiPro	EP-3 HiPro	EP-4 HiPro	EP-5 HiPro
Max. lifting capacity (kNm)	318	311	351	343	337	332
Outreach - hydraulic extensions (m)	8.0	10.3	8.0	10.3	12.7	15.1
Outreach / Lifting capacity, standard (m / kg)	3.0 / 10000	3.0 / 10000	3.0 / 10000	3.0 / 10000	3.0 / 10000	3.0 / 10000
	4.2 / 7700	4.2 / 7600	4.2 / 8500	4.3 / 8300	4.4 / 8000	4.5 / 7700
	5.9 / 5500	5.9 / 5200	5.9 / 6000	6.0 / 5800	6.1 / 5500	6.2 / 5300
	7.9 / 4100	8.0 / 3850	7.9 / 4550	8.0 / 4300	8.1 / 4050	8.2 / 3850
	-	10.2 / 3000	-	10.2 / 3350	10.3 / 3100	10.4 / 2940
	-	-	-	-	12.6 / 2540	12.7 / 2360
	-	-	-	-	-	15.0 / 1980
Slewing angle	420°	420°	420°	420°	420°	420°
Height in folded position (mm)	2613	2613	2613	2613	2613	2613
Width in folded position (mm)	2502	2502	2502	2502	2502	2502
Weight - standard version (kg)	5250*	5470*	5307*	5527*	5742*	5940*
Driving speed (m / s)	0 – 0.7	0 – 0.7	0 – 0.7	0 – 0.7	0 – 0.7	0 – 0.7

* Weight based on standard crane including 7 m stabilizer beams, long stabilizer legs and filled oil and fuel tanks.

Hiab XS 377 R EP-5 HiPro

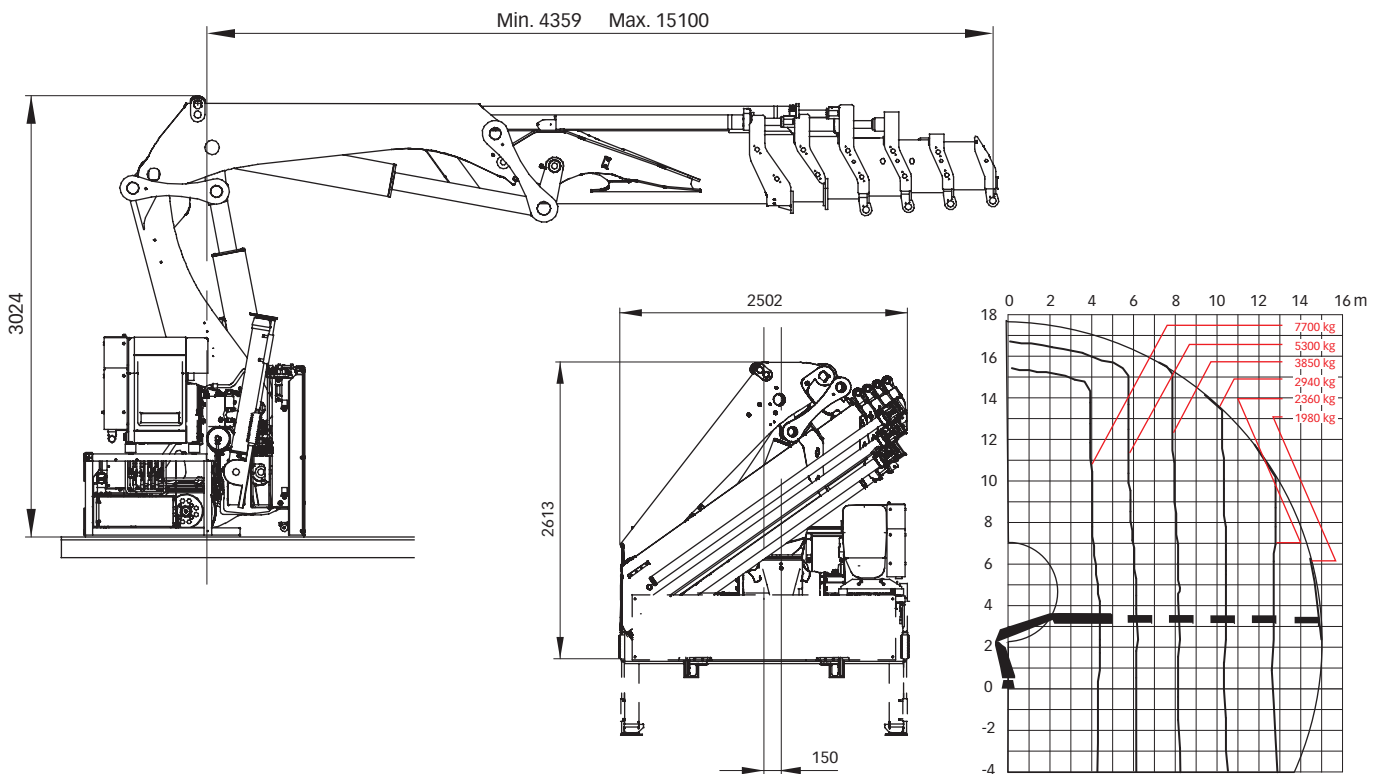

Disclaimer. Hiab cranes have been built to meet the highest standards of safety and service life and have been thoroughly tested. Strength calculations for this model have been carried out in accordance with EN13001 in fatigue class S1. Cargotec's certified Quality Assurance System complies with ISO 9001. Some of the items in our literature may be extra equipment. Certain applications may require an official permit. We reserve the right to change technical specifications without prior notice. Hiab cranes produced for EU-countries are CE-marked and comply with the European Standard EN 12999.

Cargotec improves the efficiency of cargo flows by offering solutions for the loading and unloading of goods on land and at sea – wherever cargo is on the move. Cargotec's main daughter brands for cargo handling Hiab, Kalmar and MacGregor are global market leaders in their fields. www.cargotec.com