



We build a better future

■ Photo may include optional equipment.

50/60/70DS-7E

DIESEL FORKLIFT TRUCKS Environmental - Friendly



50/60/70DS -7E

New criterion of Forklift Trucks

Hyundai introduces a new line of 7E-series diesel forklift trucks. Excellent power and performance make your business more profitable.



■ Photo may include optional equipment.



High Power & Performance

Powerful Engine

MHI S6S-T Engine

The six cylinders turbo-charged engine is built for power, reliability and economy. This engine meets EPA tier III and EU stage IIIA emission regulation.

68 kW / 2,300 rpm



State-of-the-art hydraulic system

The latest designed, large-capacity hydraulic system including a low-noise control valve shortens reaction time during operation and improves both efficiency and durability.

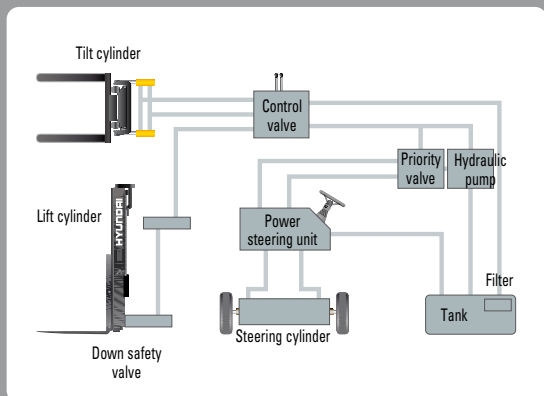

Fast and stable performance

Being able to quickly raise and lower the mast, as well as tilting forward and backward, the truck provides you the best operational conditions during loading/unloading operations. When the truck is fully loaded, mast lowering speed is carefully controlled to ensure safety by the down control valve.

The new master on your job-site!

Smooth running, efficient and ergonomically designed, 50/60/70DS-7E series are made to meet your needs.



■ Photo may include optional equipment.

Faster Travel Speed & Grade-ability

The powerful high-output engine provides greater acceleration, better grade-ability and faster travel speed on any tough terrain or slope.

Grade-ability (Loaded)

50DS-7E	46.2%
60DS-7E	40.7%
70DS-7E	36.5%

Travel speed (Unloaded)

50DS-7E	35.5 km/h
60DS-7E	35.4 km/h
70DS-7E	35.2 km/h

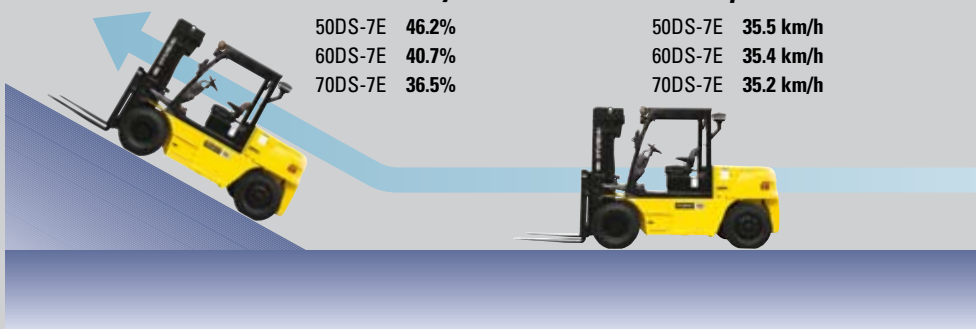

Increased mast tilting angle

Utilizing the mast tilting angle of 15 degrees forward and 10 degrees backward gives the operator a safe and rapid platform for loading and unloading jobs.



Wet disc brake system

Wet disc brakes improve the brake performance and make your service intervals longer. Enclosed brakes are protected against dust and water.



Fully hydrostatic power steering

A hydraulic steering system always guarantees smooth and flexible steering, preventing overrun and steering wheel kick-back.

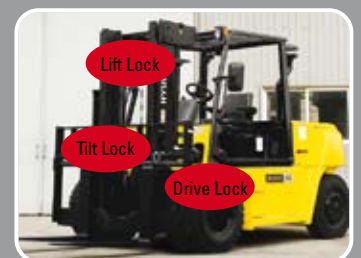

OPSS (Operator Presence Sensing System)

Mast tilting, lifting and lowering operation is not possible when the operator is not seated in normal position. (Option)

Comfortable Operation



Adjustable steering wheel

Steering wheel with horn button can be adjusted by a lever on the right-hand side for the most comfortable operator position.



Easy and safe shift lever

A single lever on the left side of the steering column gives the operator fast and easy control of speed and travel direction. The engine can only be started in case of neutral position of this lever.



Multi-function switch lever

A multi-functional switch lever gives easy access to lights and horn.



Quick Response of Operating Control Levers

Only minimal operator's effort is required for precise, safe and productive control.



■ Photo may include optional equipment.



Ergonomically positioned pedals

Based on human engineering, the accelerator, brake and inching pedals are optimally positioned for operator's convenience. Easy to remove and easy to clean cleanable rubber floor mat.



Cup holder & console box

Additional storage spaces are located inside the operating space for operator's convenience.

Comfortable Operation!

A design based on human engineering relieves fatigue and increases operator's efficiency.



New high visibility for safe operation

The operator is able to work with increased safety and accuracy due to a wider view mast.

Operator friendly gauges and water-resistant monitor panel



- 1 Parking brake lamp
- 2 Directional indicators
- 3 Fuel warning lamp
- 4 Engine oil warning lamp
- 5 Transmission oil temperature warning lamp
- 6 Battery warning lamp
- 7 Air filter warning light
- 8 Working light indicator
- 9 Water separator lamp
- 10 Pre-heater indicator
- 11 Water temperature gauge
- 12 Fuel gauge
- 13 Hour meter
- 14 Engine check lamp
- 15 Seat belt warning
- 16 OPSS warning

Easily adjustable suspension seat

An attractive and adjustable seat, based on a human engineering design, provides great comfort, safety and durability.



Full-floating headguard

Anti-vibration rubbers, installed between the cabin structure and truck frame, reduces vibrations and noise while driving. This reduces operator's fatigue and increases safety.



Endurance & Safety

Strong overhead guard

The safety overhead guard meets EEC and ANSI regulations and protects the operator during hazardous jobs.



Parking Brake

Toggle type parking brake requires less efforts from the operator to set.



Ground clearance

The engine and transmission are assembled horizontally and positioned high in the frame to protect valuable components during operations on rugged surface.

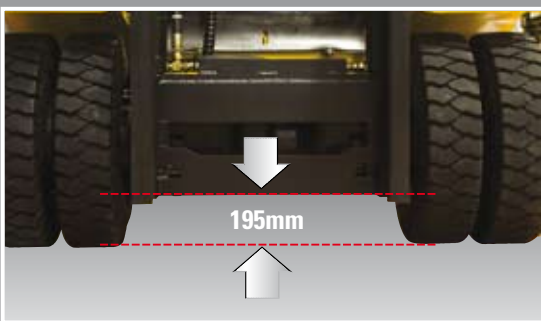

Highly Durable Electric Power-Shift Transmission

Powershift transmission provides you with fast but quiet travel speed under all heavy load conditions. So boosting your work efficiency.



Safety through high durability!

Safety and durability are priorities in the design of the equipment.



Large Footstep & Handle

Wide "open" step offers convenience and safety when entering and exiting your truck.



■ Photo may include optional equipment.

Heavy duty single unit frame

Heavy duty single unit type frame, designed on the basis of accurate structural analysis, guarantees durability and safety.



Easy access to electric parts

Various electric parts are centralized below the dash board resulting in improvement of maintenance.



Expansion bellows

The expansion bellows absorbs vibration and reduces noise generated from the exhaust gas system to extend the life span.



Fuel tank safety valve

Integrated safety check valve shuts the fuel supply in the unlikely condition of a truck overturn.



Bright, protected headlights

Bright, protected headlights and rear working light are positioned for exceptional visibility in dark environments.

Durability & Easy Maintenance



Electrically Monitored Air Filter

An air cleaner sensor alerts the operator of a restricted air filter so allowing replacement before a potential engine damage occurs.



Transparent air pre-cleaner

Efficient, accessible pre-cleaner providing a longer engine life.



Brake fluid reservoir

Highly visible and accessible reservoir makes daily inspections a quick and easy job.



An accessible, compact fuse box for easy inspection

Centralized design for easy service!

An ideal arrangement of components ensures easy access and convenience during maintenance.



Battery master switch



Key-locking fuel cap



Automatic Self Locking Gas Spring

Engine compartment hood is kept open by a self locking gas spring to improve maintenance safety.



Large tool box

Additional tool box located under footstep for operator's convenience.



Easy Change of Air Cleaner

The air filter is readily accessible for cleaning or replacement.





■ Photo may include optional equipment.

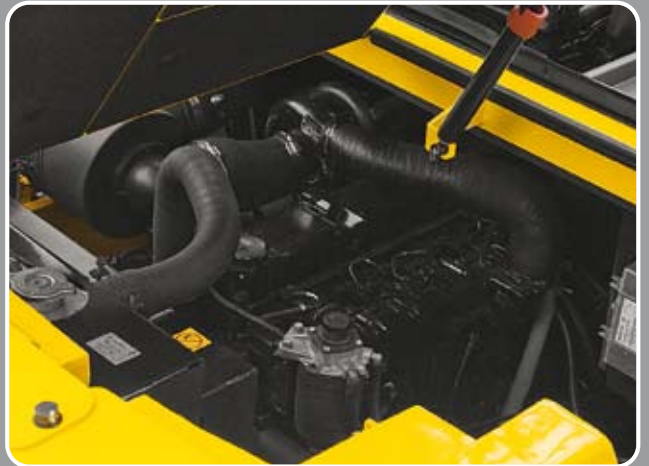

Large Open Engine Hood

Highly accessible engine compartment assures fast and efficient maintenance.



Engine oil condition check



Easy-to-access reservoir tank



Maintenance free battery



Easy-to-change radiator



Easy-to-change fuel filter

Highly accessible engine compartment enabling quick replacement of filters.

Specifications

Mast Specifications

Model	Mast Type	Maximum Fork height (mm)	Overall height (mm)			Free Lift (mm)		Tilt Angle (deg)		Load Capacity without side shift at 600mm LC (kg)	Load Capacity with side shift at 600mm LC (kg)	Truck Weight (Unloaded) (kg)	
			Lowered	Extended		Without Load Backrest	With std Load Backrest	Fwd	Bwd				
				Without Load Backrest	With std Load Backrest								
50DS-7E	2/ Stage limited free lift	V270	2,730	2,365	3,691	4,020	140	140	15	10	5,000	5,000	8,555
		*V300	3,030	2,515	3,991	4,320	140	140	15	10	5,000	5,000	8,602
		V330	3,330	2,665	4,291	4,620	140	140	15	10	5,000	5,000	8,650
		V350	3,530	2,765	4,491	4,820	140	140	15	10	5,000	5,000	8,682
		V370	3,730	2,865	4,691	5,020	140	140	15	10	5,000	5,000	8,714
		V400	4,030	3,015	4,991	5,320	140	140	15	10	5,000	5,000	8,770
		V450	4,530	3,315	5,491	5,820	140	140	15	10	5,000	5,000	8,997
		V500	5,030	3,565	5,991	6,320	140	140	15	10	5,000	5,000	9,077
		V550	5,530	3,815	6,491	6,820	140	140	15	10	5,000	5,000	9,156
	V600	6,030	4,065	6,991	7,320	140	140	15	10	5,000	4,950	9,235	
	3/ Stage full free lift	TF450	4,560	2,565	5,545	5,805	1,580	1,275	15	10	5,000	5,000	9,189
		TF500	5,060	2,765	6,045	6,305	1,780	1,475	15	10	5,000	5,000	9,281
		TF560	5,600	2,965	6,585	6,845	1,980	1,675	15	10	5,000	4,850	9,392
TF600		6,060	3,165	7,045	7,305	2,180	1,875	15	10	5,000	4,700	9,479	

Model	Mast Type	Maximum Fork height (mm)	Overall height (mm)			Free Lift (mm)		Tilt Angle (deg)		Load Capacity without side shift at 600mm LC (kg)	Load Capacity with side shift at 600mm LC (kg)	Truck Weight (Unloaded) (kg)	
			Lowered	Extended		Without Load Backrest	With std Load Backrest	Fwd	Bwd				
				Without Load Backrest	With std Load Backrest								
60DS-7E	2/ Stage limited free lift	V270	2,730	2,365	3,911	4,020	140	140	15	10	6,000	6,000	9,197
		*V300	3,030	2,515	4,211	4,320	140	140	15	10	6,000	6,000	9,245
		V330	3,330	2,665	4,511	4,620	140	140	15	10	6,000	6,000	9,292
		V350	3,530	2,765	4,711	4,820	140	140	15	10	6,000	6,000	9,324
		V370	3,730	2,865	4,911	5,020	140	140	15	10	6,000	6,000	9,356
		V400	4,030	3,015	5,211	5,320	140	140	15	10	6,000	6,000	9,412
		V450	4,530	3,315	5,711	5,820	140	140	15	10	6,000	6,000	9,640
		V500	5,030	3,565	6,211	6,320	140	140	15	10	6,000	5,950	9,719
		V550	5,530	3,815	6,711	6,820	140	140	15	10	6,000	5,750	9,799
	V600	6,030	4,065	7,211	7,320	140	140	15	10	6,000	5,600	9,877	
	3/ Stage full free lift	TF450	4,560	2,565	5,765	5,805	1,360	1,275	15	10	6,000	5,850	9,848
		TF500	5,060	2,765	6,265	6,305	1,560	1,475	15	10	6,000	5,650	9,940
		TF560	5,600	2,965	6,805	6,845	1,760	1,675	15	10	5,950	5,500	10,051
TF600		6,060	3,165	7,265	7,305	1,960	1,875	15	10	5,800	5,350	10,139	

Model	Mast Type	Maximum Fork height (mm)	Overall height (mm)			Free Lift (mm)		Tilt Angle (deg)		Load Capacity without side shift at 600mm LC (kg)	Load Capacity with side shift at 600mm LC (kg)	Truck Weight (Unloaded) (kg)	
			Lowered	Extended		Without Load Backrest	With std Load Backrest	Fwd	Bwd				
				Without Load Backrest	With std Load Backrest								
70DS-7E	2/ Stage limited free lift	V270	2,730	2,365	3,911	4,020	140	140	15	10	7,000	7,000	9,823
		*V300	3,030	2,515	4,211	4,320	140	140	15	10	7,000	7,000	9,871
		V330	3,330	2,665	4,511	4,620	140	140	15	10	7,000	7,000	9,918
		V350	3,530	2,765	4,711	4,820	140	140	15	10	7,000	7,000	9,950
		V370	3,730	2,865	4,911	5,020	140	140	15	10	7,000	7,000	9,982
		V400	4,030	3,015	5,211	5,320	140	140	15	10	7,000	7,000	10,038
		V450	4,530	3,315	5,711	5,820	140	140	15	10	7,000	7,000	10,266
		V500	5,030	3,565	6,211	6,320	140	140	15	10	7,000	6,850	10,345
		V550	5,530	3,815	6,711	6,820	140	140	15	10	7,000	6,650	10,425
	V600	6,030	4,065	7,211	7,320	140	140	15	10	7,000	6,500	10,503	
	3/ Stage full free lift	TF450	4,560	2,565	5,765	5,805	1,360	1,275	15	10	7,000	6,750	10,474
		TF500	5,060	2,765	6,265	6,305	1,560	1,475	15	10	7,000	6,600	10,566
		TF560	5,600	2,965	6,805	6,845	1,760	1,675	15	10	6,900	6,400	10,677
TF600		6,060	3,165	7,265	7,305	1,960	1,875	15	10	6,700	6,200	10,765	

Load Capacity

50DS-7E

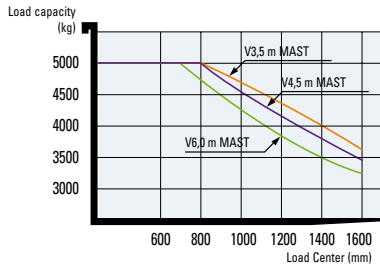

60DS-7E

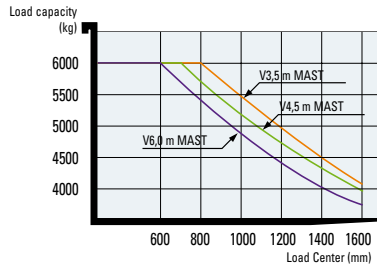

70DS-7E

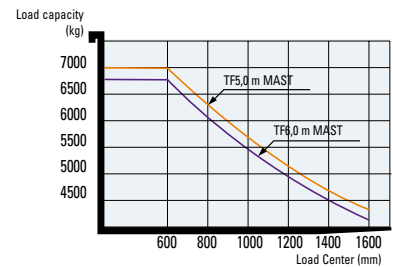
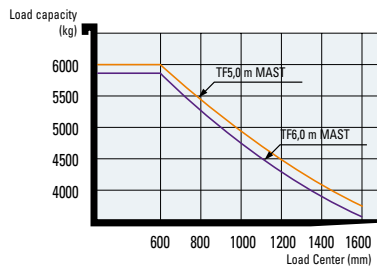
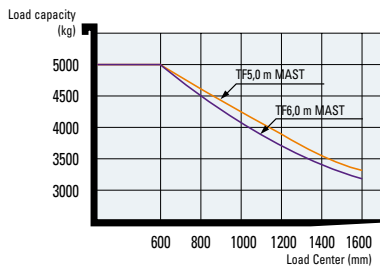
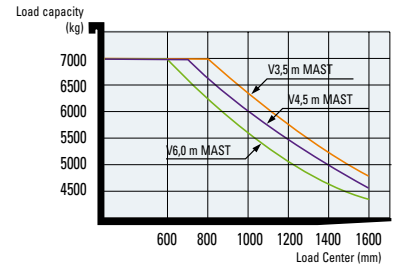

Various Attachments



Side Shift



Hinged Forks



Hinged Bucket

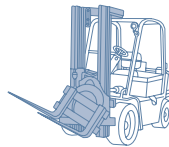

Rotating Forks



Push Pull

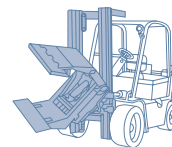

Rotating Roll Clamp

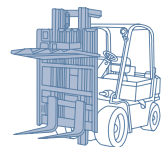

Load Stabilizer

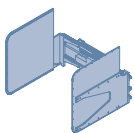

Carton Clamp

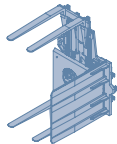

Pallet Invert

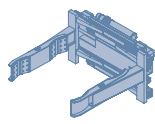

Drum Clamp

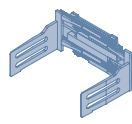

Bale Clamp

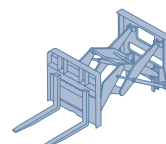

Load Extender

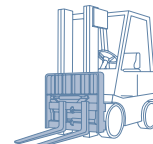

Fork Positioner

Options

FORKS (LxWxT) (mm)

50/60DS-7E (SHAFT · HOOK TYPE)

· 1,350 X 150 X 60 · 1,500 X 150 X 60 · 1,800 X 150 X 60
· 2,000 X 150 X 60 · 2,400 X 150 X 60

70DS-7E (SHAFT TYPE)

· 1,350 X 180 X 60 · 1,500 X 180 X 60 · 1,800 X 180 X 60
· 2,000 X 180 X 60 · 2,400 X 180 X 60

70DS-7E (HOOK TYPE)

· 1,350 X 150 X 65 · 1,500 X 150 X 65
· 1,800 X 150 X 65 · 2,000 X 150 X 65
· 2,400 X 150 X 65

· MCV

3-SPOOL / 4-SPOOL / 5-SPOOL

· INTERNAL PIPING

· SEAT

ARM REST

· SOLID TIRES

· FORK EXTENDERS

1,800 / 2,000 / 2,200 / 2,300

· HOSE-REEL

Dimensions

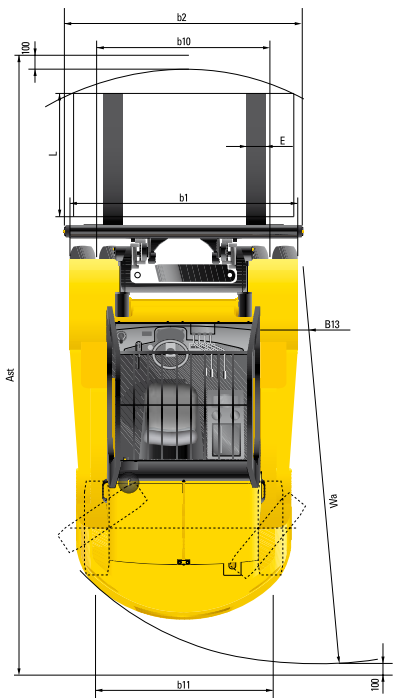
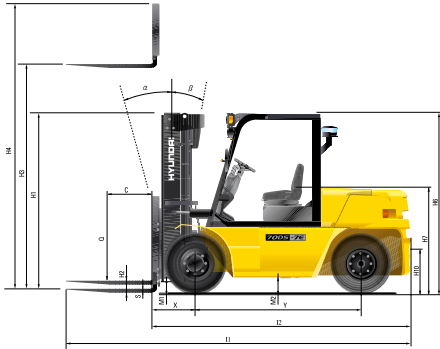

Specifications

Identification					
1.1	Manufacturer	Hyundai	Hyundai	Hyundai	
1.2	Type	60DS-7E	60DS-7E	70DS-7E	
1.3	Drive: electric (battery or mains), diesel, petrol, fuel gas, manual	DIESEL	DIESEL	DIESEL	
1.4	Type of operation: hand, pedestrian, standing, seated, order-picker	Seated	Seated	Seated	
1.5	Load capacity / rated load (standard)	kg	5,000	6,000	7,000
1.6	Load center distance	c mm	600	600	600
1.8	Load distance, center of drive axle to forks	x mm	605	615	615
1.9	Wheelbase	y mm	2,300	2,300	2,300
Weights					
2.1	Service weight	kg	8,602	9,245	9,871
2.2	Axle loading, loaded front / rear	kg	12,046 / 4,404	13,573 / 4,403	14,964 / 4,266
2.3	Axle loading, unloaded front / rear	kg	1,556 / 4,198	1,673 / 4,842	1,907 / 5,604
Wheels, Chassis					
3.1	Tires: solid rubber, superelastic, pneumatic, polyurethane	Pneumatic	Pneumatic	Pneumatic	
3.2	Tires size, front	8.25 - 15 - 14	8.25 - 15 - 14	8.25 - 15 - 14	
3.3	Tires size, rear	8.25 - 15 - 14	8.25 - 15 - 14	8.25 - 15 - 14	
3.5	Wheels, number front / rear (x = driven wheels)	4 x / 2	4 x / 2	4 x / 2	
3.6	Track width, front	mm	1,580	1,580	1,580
3.7	Track width, rear	mm	1,604	1,604	1,604
Basic Dimensions					
4.1	Mast / fork carriage tilt forward / backward	degrees	15 / 10	15 / 10	15 / 10
4.2	Lowered mast height (standard)	h1 mm	2,515	2,515	2,515
4.3	Free lift	h2 mm	140	140	140
4.4	Lift height (standard)	h3 mm	3,030	3,030	3,030
4.5	Extended mast height (standard)	h4 mm	4,275	4,275	4,275
4.7	Overhead load guard (cab) height	h5 mm	2,500	2,500	2,500
4.8	Seat height / standing height	h7 mm	1,395	1,395	1,395
4.12	Coupling height	h10 mm	425	425	425
4.19	Overall length	l1 mm	4,700	4,785	4,820
4.20	Length to face of forks	l2 mm	3,500	3,565	3,620
4.21	Overall width	b1 mm	2,087	2,087	2,087
4.22	Fork dimensions (hook type)	S x E x L mm	1,200 x 150 x 60	1,200 x 150 x 65	1,200 x 150 x 65
4.23	Fork carriage ISO 2328, class / type A, B		Class IV	Class IV	Class IV
4.24	Fork carriage width	b12 mm	2,087	2,087	2,087
4.31	Ground clearance, loaded, under mast	m1 mm	195	195	195
4.32	Ground clearance, centre of wheelbase	m2 mm	405	405	405
4.33	Aisle width for pallets 1,000 x 1,200 crossways (L x W)	Ast mm	5,075	5,140	5,175
4.34	Aisle width for pallets 800 x 1,200 lengthways (W x L)	Ast mm	5,275	5,340	5,375
4.35	Turning radius	Wa mm	3,270	3,325	3,360
4.36	Smallest pivot point distance	b13 mm	1,190	1,190	1,190
Performance Data					
5.1	Travel speed, unloaded	km/h	35.5	35.4	35.2
5.2	Lift speed, loaded / unloaded	mm/s	450 / 480	440 / 480	430 / 480
5.3	Lowering speed, loaded / unloaded	mm/s	500 / 450	500 / 450	500 / 450
5.5	Drawbar pull, loaded	kg	5,910	5,935	5,962
5.7	Gradient performance, loaded / unloaded	%	46.2 / -	40.7 / -	36.5 / -
5.9	Acceleration time, loaded / unloaded (10 m)	sec	-	-	-
5.10	Service brake		Hydraulic	Hydraulic	Hydraulic
Engine					
6.1	Engine manufacturer / type		MHI S6S-T	MHI S6S-T	MHI S6S-T
6.2	Engine power acc. to ISO 1585	kW	68	68	68
6.3	Rated speed	1/min	2,300	2,300	2,300
6.4	No. of cylinder / cubic capacity	anz/cm ³	6 / 4,996	6 / 4,996	6 / 4,996
6.5	Fuel consumption acc. to VDI cycle	l / h	5.2	5.3	5.4
Other Details					
8.1	Type of drive control		Full Auto	Full Auto	Full Auto
8.2	Operating pressure (System / attach)	bar	185 / 185	185 / 185	185 / 185
8.3	Hydraulic oil volume	l	105	105	105
8.4	Sound level at driver's ear according to DIN 12053	db (A)	82	82	82

Contact your Hyundai dealer for more information. The machine shown may vary according to International standards.
All US measurement rounded off to nearest pounds or inches. Materials and specifications are subject to change without notice.

HYUNDAI | MATERIAL HANDLING

HEAVY INDUSTRIES CO., LTD.

Head Office (Sales Office)
1 JEONHA-DONG, DONG-GU, ULSAN, KOREA Tel (82) (52) 202-7970, 7729, 0971 Fax (82) (52) 202-7979, 7720

U.S. Operation : Hyundai Construction Equipment U.S.A., Inc.
955 ESTES AVENUE, ELK GROVE VILLAGE IL, 60007 Tel (1) 847-437-3333 Fax (1) 847-437-3574

European Operation : Hyundai Heavy Industries Europe N.V.
VOSSENDAAL 11, 2440 GEEL, BELGIUM Tel (32) 14-562200 Fax (32) 14-593405-06

India Operation : Hyundai Construction Equipment India PVT., Ltd
PLOT NO.A-2, CHAKAN INDUSTRIAL AREA, VILL.- KHALUMBRE.
TALUK.- KHED, DIST.- PUNE 410 501, INDIA Tel (91) 21-3530-1700 Fax (91) 21-3530-1712

PLEASE CONTACT