

Mining Excavator

R 984 C

Operating Weight with Backhoe Attachment:	120,100 kg / 264,775 lb
Operating Weight with Shovel Attachment:	125,100 kg / 275,798 lb
Engine Output:	504 kW / 685 hp
Bucket Capacity:	2.90 - 8.00 m ³ / 3.7 - 10.4 yd ³
Shovel Capacity:	5.70 - 9.00 m ³ / 7.4 - 11.7 yd ³



LIEBHERR

R 984 C

Operating Weight with Backhoe Attachment:	120,100 kg / 264,775 lb
Operating Weight with Shovel Attachment:	125,100 kg / 275,798 lb
Engine Output:	504 kW / 685 hp
Bucket Capacity:	2.90 - 8.00 m ³ / 3.7 - 10.4 yd ³
Shovel Capacity:	5.70 - 9.00 m ³ / 7.4 - 11.7 yd ³



Productivity and Efficiency

Liebherr's R 984 C mining excavator is the most flexible digging and loading tool. It can be customized for all mining applications for maximum performance. Even under the hardest conditions, it achieves high productivity. Always ready for job, the R 984 C is your key to the lowest operating and owning cost per tonne.

Reliability

More than 50 years of experience in designing and manufacturing hydraulic excavators are the basis for the outstanding reliability of the R 984 C. This excavator combines innovative solutions, excellent design and Liebherr long-life components, ensuring maximum availability and performance throughout the whole equipment life.

Customer Support

On site, Liebherr's customer support delivers tailor-made professional solutions to your project specifics and site requirements. Liebherr offers a partnership with the goal of mining more for less.

Operating and Servicing

The R 984 C's operator cab creates a comfortable and ergonomic working environment. Furthermore, the ergonomic component access and long service intervals assist the service team to ensure more uptime.

Safety and Environment

The Liebherr R 984 C provides uncompromising safety for operators and maintenance crews, with innovative technologies integrated into the machine.





Quick Change Adapter

The optional Liebherr quick change adapter assists in changing tools like bucket or ripper without getting out of the cab. This considerably saves time compared to changing hydraulic flexible devices:

- No nuts or pins needed
- No assembly and disassembly of the axis
- Remote control from inside cab
- No manual intervention needed



Productivity and Efficiency

Liebherr's R 984 C mining excavator is the most flexible digging and loading tool. It can be customized for all mining applications for maximum performance. Even under the hardest conditions, it achieves high productivity. Always ready for job, the R 984 C is your key to the lowest operating and owning cost per tonne.

Reach a New Level of Productivity

High Digging Forces

With a multitude of possible backhoe attachments configurations and a wide range of buckets the R 984 C provides the highest crowd and breakout forces in every application. Even under tough conditions Liebherr's R 984 C high digging force allows easy bucket penetration and favorable bucket fill factors to achieve high productivity.

Closed Loop Swing Circuit

With an independent swing circuit the machine allows the maximum swing torque whilst retaining the full oil flow for the working circuit.

Compact Machine Design

Liebherr's excavator design is well-balanced and provides best machine stability. The high weight distribution towards the undercarriage contributes to an efficient utilization of the strong digging forces and a favorable power to weight ratio of the uppercarriage and attachment.

Efficiency for Less Cost

Efficient Cooling System

Liebherr's large dimensioned cooling system reduces fan power consumption and ensures an ideal machine temperature. The hydrostatic fans operate always on the required level.

High Hydraulic Efficiency

The high pressure level of Liebherr hydraulic system together with the optimized pipe and hose layout maximize the usable power transmission. The Pressure Less Boom Down function combined with the oil regeneration on the attachment saves energy and reduces swing back time.

Automatic Idle Control

The electronic control of the hydraulic system and engine allows automatic idle mode contributing to less fuel consumption and load on the engine.

Highest Digging and Breakout Forces

- Advanced attachment technology and design for optimized digging and breakout force distribution
- Strong structure design
- Liebherr heavy duty bucket solution

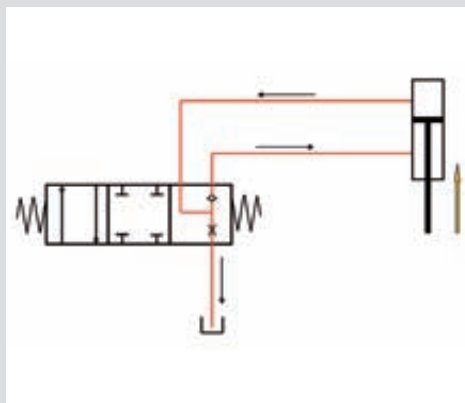

Regeneration System

Retraction of attachment cylinders without pump energy:

- Pump flow can be used for other cylinder motions during retraction of boom cylinders
- Reduced fuel consumption
- Saving of time



Liebherr Hydraulic Oil Filtration

- Standard: Integrated 5 μ bypass hydraulic oil filtration
- Optional: Additional external bypass filtration system with water separation for operations in wet areas



Reliability

More than 50 years of experience in designing and manufacturing hydraulic excavators are the basis for the outstanding reliability of the R 984 C. This excavator combines innovative solutions, excellent design and Liebherr long-life components, ensuring maximum availability and performance throughout the whole equipment life.

Experience Liebherr Quality

Over 50 Years of Experience

Since 1954, Liebherr has been designing, manufacturing and servicing crawler mounted excavators used in toughest applications. Like its predecessors, Liebherr's R 984 C benefits from this long-time experience in the customer-focused design with modern engineering solutions and extensive mining knowledge.

Quality Management

Liebherr's quality processes commence with the machine design and simulations. Liebherr meets the highest industry standards for special selections of steels and selection of special casting materials. During manufacturing and assembly, Liebherr quality management follows all manufacturing steps, ensuring highest quality of each machine delivered. Liebherr hydraulic excavator plants are ISO 9001 certified.

Heavy Duty Excavator

First-class components and machine steel structures ensure a high machine reliability, even in hard mining conditions.

Advanced Design of All Mining Applications

Machine Design

Liebherr's design processes include the latest and product specific numerical engineering tools, such as Finite Element Analyses, Fatigue Calculations, Torque and Displacement Analysis and Multibody Simulations. These modern techniques allow reliable engineering solutions for series and special applications.

Specific Solutions

As each project is unique, Liebherr is developing and supplying solutions to ensure performance and reliability in specific mining environments. Liebherr's R 984 C can be customized to operate in regions with temperatures of down to -40°C / -40°F or up to 55°C / 131°F , as well as in high-altitude regions of up to 4,000 m above sea level. Liebherr also offers specific bucket-tailored solutions for each type of application.

Cold / Hot Temperature Kit

Designed for maximum reliability in regions with temperatures of down to -40°C / -40°F or up to 55°C / 131°F .

- Integrated into machine structure
- Maximum efficiency
- Increases machine and component lifetime
- Optimum operator comfort even in hard temperature conditions



Liebherr Components

- Major components developed and manufactured in-house
- Designed specifically for mining operations
- Liebherr Service Exchange Program



Service Exchange Units (SEU)

Rebuild programs for components are conducted by Liebherr-certified repair shops, using best practice guidance to ensure:

- Maximum component life
- Long-term reliability
- High performance
- Cost-efficiency
- High quality



Customer Support

On site, Liebherr's customer support delivers tailor-made professional solutions to your project specifics and site requirements. Liebherr offers a partnership with the goal of mining more for less.

Your Mining Partner

Parts Logistics and Services

Liebherr parts and service follow the machine into the field with international logistics platforms ensuring parts supply and maintenance services worldwide.

Customized Service and Product Support

Depending on specific requirements, Liebherr offers tailored support solutions integrating parts exchange and management agreements, service and maintenance on site or maintenance management agreements.

Service Exchange Units

Rebuild programs for components are conducted by Liebherr-certified repair shops, ensuring rebuilt component life and reliability match new component performance expectations.

Complete Training Solutions

Dedicated to mining the Liebherr training team provides operator and maintenance staff training programs to allow cost-efficient and safe operations. Liebherr offers customized on-site training courses according to your needs.

Factory Support

Service Engineering

Liebherr design and field service engineers accompany the excavators throughout the whole machine life. Liebherr's sales and service organizations and the Liebherr factories' product engineering groups provides fast and proactive support to the mining industry.

Service Tools

Liebherr affords service tools for excavator-specific maintenance which ensure safe working even when hand-ling large excavator components.



Liebherr Service Tools

- Fast component replacement
- Designed specifically for requirements on Liebherr machines
- High operational safety
- Cost-efficiency for service operations
- Usable on different excavator sizes



Liebherr Training Programs

Competence-based training, employing an interdisciplinary learning strategy:

- Liebherr Mining Training Centers
- Available in different languages
- Customized training courses on site



Comfort in Cab

- Outstanding visibility over the whole working environment
- Automatic air condition
- Tinted laminated safety glass
- Pressurized to prevent dust penetration
- Low vibration and super silent
- Adjustable seat



Operating and Servicing

The R 984 C's operator cab creates a comfortable and ergonomic working environment. The ergonomically optimized machine controls assure the best operator performance throughout each shift. Furthermore, the ergonomic component access and long service intervals assist the service team to ensure more uptime.

Operator Workplace

Comfortable Working Environment

The large R 984 C's spacious cab offers ideal working conditions and first-class comfort. The fully adjustable seat and control fits to individual needs. The position of the operator station together with the large windows allow an outstanding visibility over the whole working environment. The cab's effective insulation creates a quiet working environment for maximum productivity.

Ergonomic Control Elements

The configuration and placement of operator control elements and monitoring displays are perfectly coordinated to support the productive performance. The electronic control is easy and intuitive to use. The dashboard and machine control panel are easy to access and arranged for fast overview on major machine functions.

Easy Serviceability

Ergonomic Service Access

The R 984 C provides ergonomic component access for fast and efficient service. All service points are within reach through large catwalks and walkways. The optional ground fast filling connections gives easy and safe refilling of service fluids, saving time, preventing spillage and reducing contamination by dust. The electronic health monitoring system assists in trouble-shooting and maintenance tasks. Liebherr excavators are equipped with louvers for easy access of ground based support tools.

Extended Service Intervals

The R 984 C offers all features for extended machine services intervals. The technical layout of filtration systems with integrated bypass hydraulic oil filters and the large dimensioned grease systems are only some examples.



Automatic Greasing System

All attachment and swing ring lubrication points are connected to the automatic lubrication system

- Robust single line central lubrication system
- Adjustable injectors
- Greasing points are protected against external damages
- Grease control in operator's reach in the cab

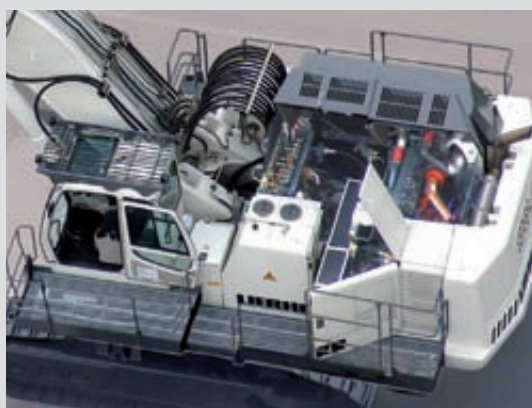

Ergonomic Service Access

Safe and efficient service through:

- Large catwalk and platform
- All service points on engine, fan drive and hydraulic valve blocks are accessed from one large central platform
- Hinged louvers for easy cleaning and maintenance tasks
- Optional fast filling connections



Safe machine access

- Optional uppercarriage mounted re-tractable access ladder
- Access ladders and catwalks feature handrails and slip-resistant surfaces
- Emergency egress with handrail at the front of the excavator
- Optional wide catwalk with railings



Safety and Environment

The Liebherr R 984 C provides uncompromising safety for operators and maintenance crews, with innovative technologies integrated into the machine.

Safety Integrated Design

Easy and Safe Machine Access

All railings and catwalks are laid out to easily access all relevant machine areas. An optional wide catwalk is available.

Protected Operator and Service Crew

The laminated windows create a safe working environment for operators. Emergency stop arrangements in the cab and optionally in the engine compartment ensure safe maintenance tasks. Safety standards are achieved by a separated engine and pump compartment, heat insulation on turbochargers and on the exhaust system as well as by the use of heavy duty high resistant hydraulic hoses.

Environmental Care

Eco Features

Throughout the whole design and manufacturing process of Liebherr machines, environmental protection is given high priority. Material used for machine assembly is recyclable at 95%. The hydraulic system allows the use of biodegradable hydraulic oils. The automatic idle mode contributes to less fuel consumption and less load on the engine resulting in reduced CO₂ emissions.

Efficiency and Environmental Standards

Powered with the Cummins QSK 19 diesel engine EPA Tier 2 or 3, the R 984 C offers fuel-efficient operations meeting the latest emission standards.



Optional Safety Features

- Kit for Mining and Quarry Application including : emergency stop button, fire extinguisher and protective grid on the top of the cab
- Cab protection FOPS
- Protective grid for front cab window
- Travel alarm



Fire Suppression System (optional)

- Dry chemical system
- Checkfire control module including automatic detection / actuation
- Anti-restart relay (1 hour) after operating of the fire suppression system

Technical Data



Engine

1 Cummins diesel engine	
Rating per ISO 9249	523 kW/710 hp at 2,100 rpm reduced to 504 kW/675 hp at 1,800 rpm
Model	QSK-19 C 750
Type	6 cylinder in-line engine
Bore/Stroke	159/159 mm/6.26/6.26 in
Displacement	18.9 l/1,153 in ³
Engine operation	4-stroke diesel direct injection turbo-charged reduced emissions
Cooling	water-cooled
Air cleaner	dry-type air cleaner with pre-cleaner, primary and safety elements, automatic dust discharge
Fuel tank	1,585 l/419 gal
Standard	sensor controlled engine idling
Electrical system	
Voltage	24 V
Batteries	2 x 144 Ah/12 V
Starter	24 V/9.0 kW
Alternator	three phase current 24 V/100 A



Hydraulic System

Hydraulic pump for attachment and travel drive	3 Liebherr variable flow, swash plate pumps
Max. flow	3 x 472 l/min./3 x 125 gpm
Max. pressure	320 bar/4,640 psi
Pump regulation	electro-hydraulic with electronic engine speed sensing regulation, pressure com- pensation, automatic oil flow optimizer
Hydraulic pump for swing drive	reversible, variable flow, swash plate pump, closed-loop circuit
Max. flow	403 l/min./106 gpm
Max. pressure	340 bar/4,931 psi
Hydraulic tank	880 l/232 gal
Hydraulic system	1,660 l/438 gal
Hydraulic oil filter	2 full flow filters in return line with inte- grated fine filter area (5 µm), 1 high pres- sure filter for each main pump
Cooler	compact cooler, consisting of a water cooler, sandwiched with hydraulic oil cooler, aftercooler cores and air condi- tioning, hydrostatically driven fan
MODE selection	adjustment of machine performance and the hydraulics via a mode selector to match application
LIFT	for lifting
FINE	for precision work and lifting with sensitive movements
ECO	for economical operation
POWER	for maximum digging power and heavy duty jobs
RPM adjustment	stepless adjustment of engine output via rpm at each selected mode



Hydraulic Controls

Power distribution	via monoblock control valves with inte- grated safety valves
Flow summation	to boom stick and bucket cylinders
Closed-loop circuit	for uppercarriage swing drive
Servo circuit	
Attachment and swing	proportional via joystick levers
Travel	proportional via foot pedals or removable hand levers
Additional functions	via foot pedals or joystick toggle switch



Electric System

Electric isolation	easy accessible battery isolations
Working lights	high brightness halogen lights: - 2 on working attachment - 2 on RHS of uppercarriage - 1 on LHS of uppercarriage Xenon lights in option
Emergency stop switches	in the cab/in option in engine compartment
Electrical wiring	heavy duty execution in IP 65 standard for operating conditions of - 50 °C to 100 °C/ - 58 °F to 212 °F



Swing Drive

Drive by	Liebherr swash plate motor
Transmission	Liebherr compact planetary reduction gear
Swing ring	Liebherr, sealed single race ball bearing swing ring, internal teeth
Swing speed	0 - 5.2 rpm stepless
Holding brake	wet multi-disc (spring applied, pressure released)
Option	pedal controlled positioning brake



Uppercarriage

Design	torque resistant modular design upper frame
Attachment mounting	parallel length girders
Catwalks	on both sides (large catwalks with handrails and access ladder available in option)

Technical Data



Operator's Cab

Cab	profiles and deep drawn technology, resiliently mounted, sound insulated, tinted windows. Front window armored glass, door with sliding window
Operator's seat	shock absorbing suspension, adjustable to operator's weight, 6-way adjustable seat with mountable head rest
Joysticks	integrated into adjustable seat consoles
Monitoring	menu driven query of current operating conditions via the LCD display. Automatic monitoring, display, warning (acoustical and optical signal) and saving machine malfunction data, for example, engine overheating, low engine oil pressure or low hydraulic oil level
Rear vision system	camera installation on counterweight displayed over an additional LCD-display
Heating system	standard automatic air conditioning, combined cooler/heater, additional dust filter in fresh air/recirculated
Noise level (ISO 6396)	L_{pa} (inside cab) = 73.7 dB(A) with oil/water fans at 70 % and AC fan at 65 %



Undercarriage

Version HD	heavy duty
Drive	Liebherr swash plate motors
Transmission	Liebherr planetary reduction gears
Travel speed	0 – 2.9 km/h / 0 – 1.8 mph
Drawbar pull max.	872 kN / 196,033 lbf
Track components	track pitch 280 mm / 11", maintenance-free
Track rollers / Carrier rollers	9/2
Track pads	double grouser
Parking brake	wet multi-discs (spring applied, pressure released)
Brake valves	integrated in main valve block



Central Lubrication System

Type	Lincoln Centromatic lubrication system, for the entire attachment/swing ring bearing and teeth
Grease pumps	1 Lincoln lubrigun (pneumatic) pump for attachment/swing ring bearing lubrication (Lincoln Flowmaster hydraulic pump in option) 1 Lincoln P203 (electric) pump for swing teeth lubrication
Capacity	30 l / 7.9 gal bulk container for attachment/swing ring bearing, separated 8 l / 2.1 gal container for swing ring teeth
Refill	via quick connection and grease filter for the attachment/swing ring bearing circuit via filling point located directly on the pump for the swing ring teeth circuit



Attachment

Type	box-type, combination of resistant steel plates and cast steel components
Hydraulic cylinders	Liebherr design
Pivots	sealed, low maintenance
Pivots bucket-to-stick	
bucket-to-link	O-ring sealed and completely enclosed
Hydraulic connections	pipes and hoses equipped with SAE split-flange connections

Dimensions

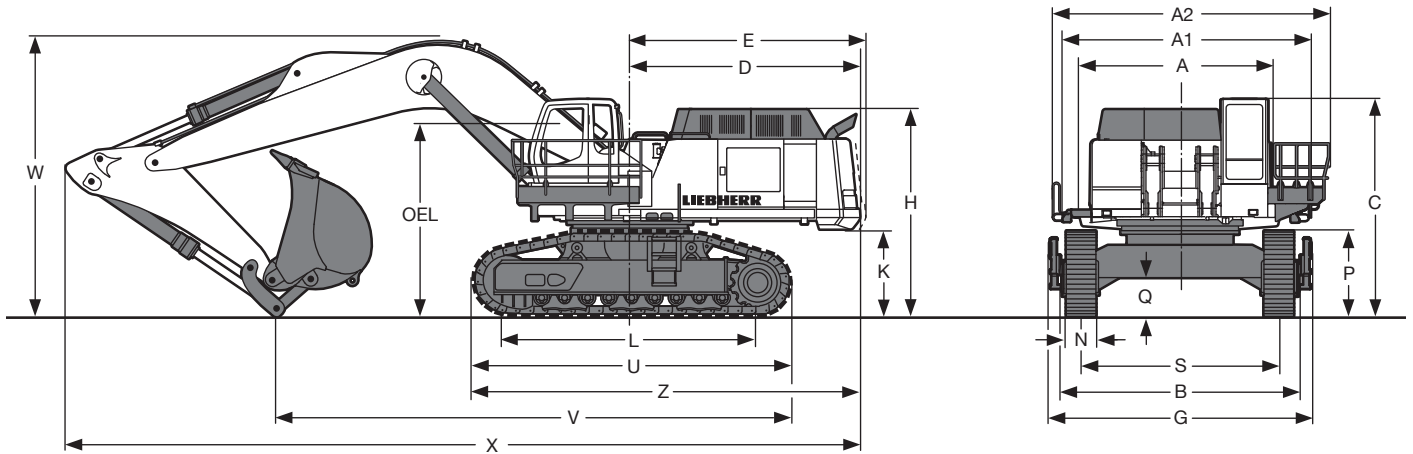

	mm/ft in
A	4,050/13' 3"
A1	5,275/17' 3"
A2	5,760/18'10"
C	4,465/14' 7"
D	4,690/15' 4"
E	4,805/15' 9"
H	4,295/14' 1"
K	1,840/ 6'
L	5,055/16' 6"
P	1,750/ 5' 8"
Q	863/ 2' 9"
S	4,000/13' 1"
U	6,471/21' 2"
N	500/1'7" 600/1'11" 750/ 2' 5"
B	4,942/16' 2"
G	5,290/17' 4"
Z	7,985/26' 2"
OEL	Operator's Eye Level 3,960/12'11"

	Stick Length m/ft in	Gooseneck Boom	Gooseneck Boom	Gooseneck Boom
		7.80 m/ 25'7"	9.20 m/ 30'2"	11.00 m/ 36'
V	3.40/11'1"	8,800/28'10"	10,550/34'7"	-/-
	4.50/14'9"	8,500/27'10"	10,250/33'7"	12,150/39'10"
	5.60/18'4"	-/-	10,150/33'3"	11,900/39'
	6.80/22'3"	-/-	8,350/27'4"	10,000/32' 9"
W	3.40/11'1"	5,650/18' 6"	5,850/19'2"	-/-
	4.50/14'9"	6,300/20' 7"	6,250/20'6"	6,650/21' 9"
	5.60/18'4"	-/-	6,950/22'9"	7,000/22'11"
	6.80/22'3"	-/-	7,950/26'	7,750/25' 5"
X	3.40/11'1"	14,850/48' 8"	16,250/53'3"	-/-
	4.50/14'9"	14,300/46'10"	15,650/51'3"	17,400/57'
	5.60/18'4"	-/-	15,400/50'6"	17,200/56' 4"
	6.80/22'3"	-/-	14,700/48'2"	16,750/54'11"

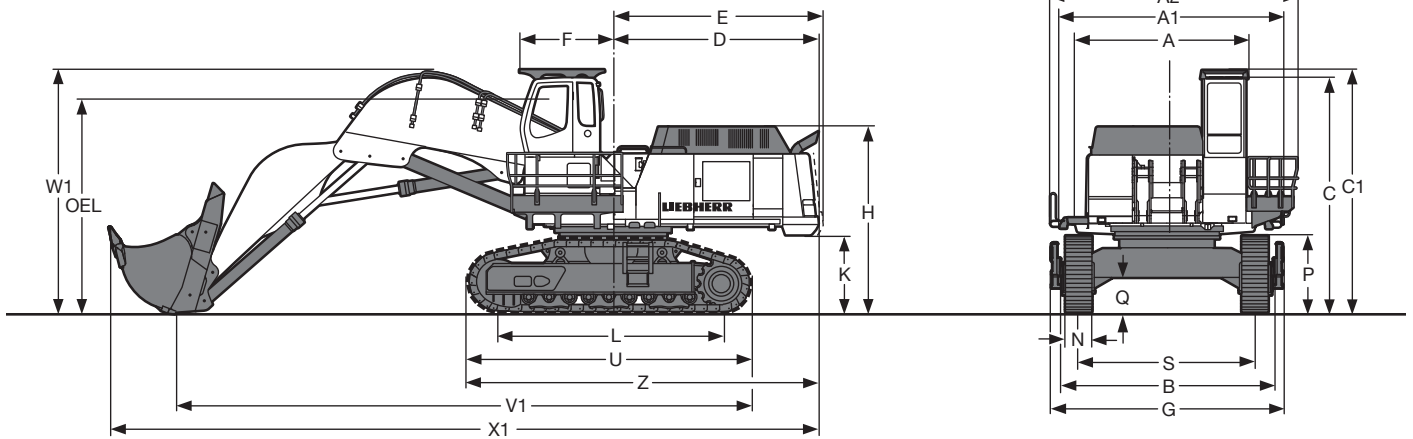

	mm/ft in
A	4,050/13' 3"
A1	5,275/17' 3"
A2	5,760/18'10"
C	5,265/17' 3"
C1	5,430/17' 9"
D	4,690/15' 4"
E	4,805/15' 9"
F	2,075/ 6' 9"
H	4,295/14' 1"
K	1,840/ 6'
L	5,055/16' 6"
P	1,750/ 5' 8"

	mm/ft in
Q	863/ 2' 9"
S	4,000/13' 1"
U	6,471/21' 2"
Z	7,985/26' 2"
N	500/1'7" 600/1'11" 750/ 2' 5"
B	4,942/16' 2"
G	5,290/17' 4"
V1	12,600/41' 3"
W1	5,400/17' 8"
X1	15,500/50'10"
OEL	Operator's Eye Level 4,760/15' 7"

Backhoe Attachment

with Gooseneck Boom 7.80 m/25'7"

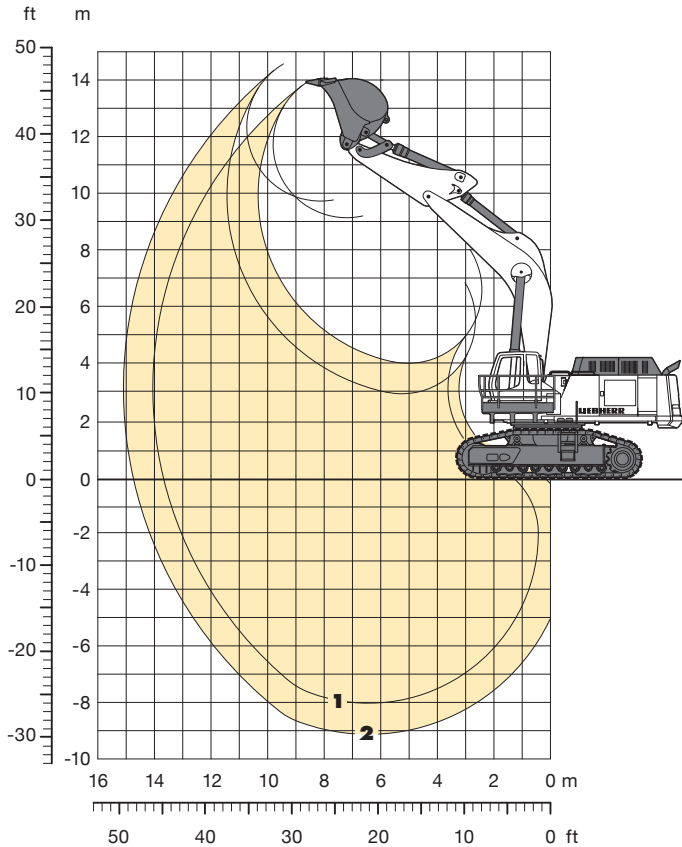

Digging Envelope

		1	2
Stick lengths	m	3.40	4.50
	ft in	11' 1"	14' 9"
Max. digging depth	m	7.95	9.05
	ft in	26'	29' 8"
Max. reach at ground level	m	13.70	14.75
	ft in	44' 11"	48' 4"
Max. dump height	m	9.20	9.80
	ft in	30' 2"	32' 1"
Max. teeth height	m	14.00	14.65
	ft in	45' 11"	48'
Max. digging force (SAE)	kN	416	346
	lbf	93,521	77,784
Max. breakout force (SAE)	kN	550	550
	lbf	123,645	123,645

Operating Weight and Ground Pressure

The operating weight includes the basic machine with gooseneck boom 7.80 m/25'7", stick 3.40 m/11'1" and bucket 7.00 m³/9.16 yd³.

Undercarriage		HD	
Pad width	mm/ft in	600/1'11"	750/2'5"
Weight	kg/lb	120,100/264,775	121,300/267,420
Ground pressure	kg/cm ² /psi	1.80/25.60	1.46/20.77

Buckets

For materials classe according to VOB, Section C, DIN 18300		< 5	< 5	< 5	5 – 6	5 – 6	5 – 6	7 – 8	7 – 8	7 – 8
Typical operation according to VOB, Section C, DIN 18300		GP	GP	GP	HD	HD	HD	XHD	XHD	XHD
Capacity ISO 7451	m ³	8.00	7.30	6.70	7.70	7.00	6.40	6.70	6.20	5.80
	yd ³	10.46	9.55	8.76	10.07	9.16	8.37	8.76	8.11	7.59
Suitable for material up to a specific weight of										
with stick 3.40 m	t/m ³	1.6	1.8	2.0	1.6	1.8	2.0	1.6	1.8	2.0
with stick 11'1"	lb/yd ³	2,698	3,035	3,373	2,698	3,035	3,373	2,698	3,035	3,373
with stick 4.50 m	t/m ³	–	1.5	1.65	–	1.5	1.65	–	–	1.65
with stick 14'9"	lb/yd ³	–	2,530	2,782	–	2,530	2,782	–	–	2,782
Cutting width	mm	2,600	2,400	2,250	2,550	2,400	2,250	2,600	2,500	2,500
	ft in	8'6"	7'10"	7'4"	8'4"	7'10"	7'4"	8'6"	8'2"	8'2"
Weight	kg	7,200	6,800	6,600	7,700	7,500	7,200	9,300	9,000	8,200
	lb	15,873	14,991	14,550	16,976	16,535	15,873	20,503	19,842	18,078

GP: General purpose bucket with Esco V 69 SD teeth

HD: Heavy-duty bucket with Esco V 71 SD teeth

XHD: Heavy-duty rock bucket with Esco V 71 SD teeth

Lift Capacities

with Gooseneck Boom 7.80 m/25'7"

Stick 3.40 m

Height (m)	Radius of load from centerline of machine (m)									
	3.0	4.5	6.0	7.5	9.0	10.5	12.0	13.5	15.0	16.5
12.0										
10.5										
9.0						13.1# (13.1#)				
7.5					14.8# (14.8#)	13.4# (13.4#)				
6.0				19.0# (19.0#)	16.1# (16.1#)	14.1# (14.1#)	12.7# (12.7#)			
4.5			28.2# (28.2#)	21.6# (21.6#)	17.6# (17.6#)	14.9# (14.9#)	12.9# (13.1#)			
3.0			32.3# (32.3#)	23.9# (23.9#)	19.0# (19.0#)	15.8# (15.8#)	12.4# (13.4#)			
1.5			34.7# (34.7#)	25.7# (25.7#)	20.1# (20.1#)	15.6# (16.4#)	11.9# (13.6#)			
0		25.7# (25.7#)	35.4# (35.4#)	26.4# (26.4#)	19.6# (20.6#)	14.9# (16.6#)	11.6# (13.4#)			
- 1.5	21.4# (21.4#)	34.6# (34.6#)	34.4# (34.4#)	25.8# (26.0#)	19.0# (20.3#)	14.6# (16.1#)				
- 3.0	31.8# (31.8#)	42.5# (42.5#)	31.8# (31.8#)	24.4# (24.4#)	18.8# (19.0#)	14.4# (14.4#)				
- 4.5	44.3# (44.3#)	35.7# (35.7#)	27.3# (27.3#)	21.0# (21.0#)	15.8# (15.8#)					
- 6.0		25.8# (25.8#)	20.1# (20.1#)	14.9# (14.9#)						
- 7.5										
- 9.0										
- 10.5										
- 12.0										

Stick 4.50 m

Height (m)	Radius of load from centerline of machine (m)									
	3.0	4.5	6.0	7.5	9.0	10.5	12.0	13.5	15.0	16.5
12.0										
10.5						10.7# (10.7#)				
9.0						10.7# (10.7#)	8.8# (8.8#)			
7.5						11.2# (11.2#)	10.5# (10.5#)			
6.0						13.6# (13.6#)	12.1# (12.1#)	10.9# (10.9#)		
4.5						18.6# (18.6#)	15.4# (15.4#)	13.1# (13.1#)	11.5# (11.5#)	8.3# (8.3#)
3.0						28.7# (28.7#)	21.5# (21.5#)	17.1# (17.1#)	14.2# (14.2#)	9.3# (9.6#)
1.5						32.5# (32.5#)	23.9# (23.9#)	18.6# (18.6#)	15.2# (15.2#)	11.9# (12.7#)
0		25.4# (25.4#)	34.6# (34.6#)	25.4# (25.4#)	19.7# (19.7#)	14.9# (15.8#)	11.3# (12.9#)			
- 1.5	17.0# (17.0#)	30.2# (30.2#)	34.9# (34.9#)	25.9# (25.9#)	18.9# (20.0#)	14.3# (15.9#)	11.0# (12.7#)			
- 3.0	24.6# (24.6#)	38.2# (38.2#)	33.6# (33.6#)	25.2# (25.2#)	18.4# (19.5#)	14.0# (15.2#)	10.9# (11.5#)			
- 4.5	33.8# (33.8#)	42.0# (42.0#)	30.6# (30.6#)	23.2# (23.2#)	17.8# (17.8#)	13.3# (13.3#)				
- 6.0	45.5# (45.5#)	34.3# (34.3#)	25.5# (25.5#)	19.3# (19.3#)	14.1# (14.1#)					
- 7.5		22.9# (22.9#)	17.2# (17.2#)	11.9# (11.9#)						
- 9.0										
- 10.5										
- 12.0										

The load values are quoted in tons (t) on the backhoe bucket's load hook, and may be swung 360° on firm and even ground. Values quoted in brackets apply to the undercarriage when in longitudinal position. Capacities are valid for 600 mm wide double grouser pads. Indicated loads are based on ISO 10567 standard and do not exceed 75 % of tipping or 87 % of hydraulic capacity (indicated via #). Maximum load for the backhoe bucket's lifting eye is 27 t. Without bucket (6.40 m³), the lift capacities will increase by 7,200 kg, without bucket cylinder, link and lever they increase by an additional 1,900 kg. Lifting capacity of the excavator is limited by machine stability, hydraulic capacity and maximum permissible load of the load hook.

When lifting loads, the hydraulic excavator must be equipped with automatic check valve on its hoist cylinders and overload warning device according to European Standard, EN 474-5.

Backhoe Attachment

with Gooseneck Boom 9.20 m/30'2"

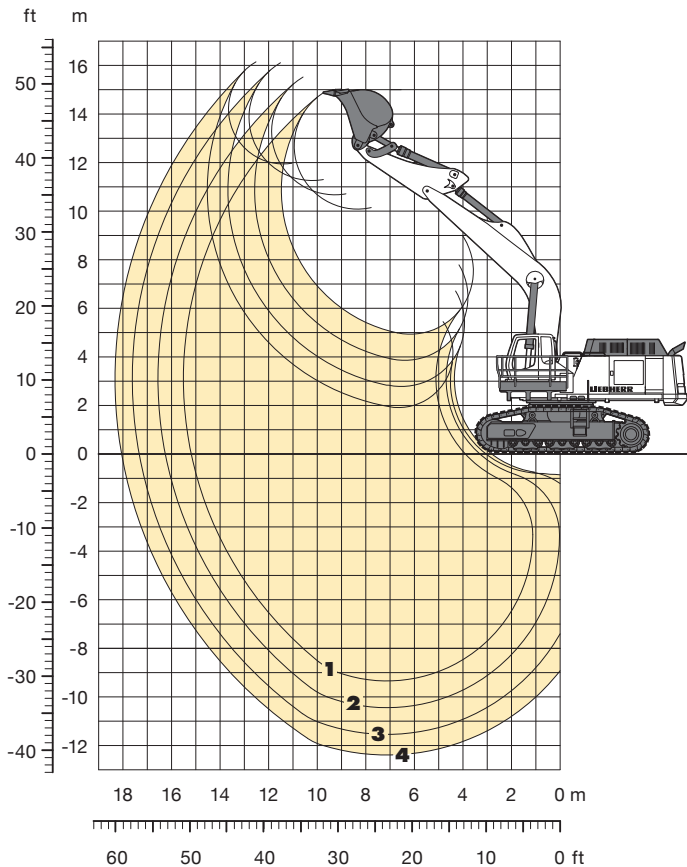

Digging Envelope		1	2	3	4*
Stick lengths	m	3.40	4.50	5.60	6.80
	ft in	11'1"	14'9"	18'4"	22'3"
Max. digging depth	m	9.25	10.35	11.45	12.30
	ft in	30'4"	33'11"	37'6"	40'4"
Max. reach at ground level	m	15.20	16.25	17.35	18.10
	ft in	49'10"	53'3"	56'10"	59'4"
Max. dump height	m	10.20	10.85	11.45	12.20
	ft in	33'5"	35'7"	37'6"	40'
Max. teeth height	m	15.00	15.70	16.35	16.40
	ft in	49'2"	51'5"	53'7"	53'9"
Max. digging force (SAE)	kN	416	346	300	273
	lbf	93,521	77,784	67,443	61,373
Max. breakout force (SAE)	kN	550	550	550	405
	lbf	123,645	123,645	123,645	91,048

* with stick 6.80 m with R 974 B Litronic® buckets

Operating Weight and Ground Pressure

The operating weight includes the basic machine with gooseneck boom 7.80 m/25'7", stick 3.40 m/11'1" and bucket 7.00 m³/9.16 yd³.

Undercarriage		HD
Pad width	mm/ft in	600/1'11" 750/2'5"
Weight	kg/lb	118,800/261,909 120,000/264,554
Ground pressure	kg/cm²/psi	1.78/25.32 1.44/20.48

Buckets

Capacity ISO 7451	m³	2.90	3.50	3.90	4.70	5.50	6.20	2.70	3.20	3.80
	yd³	3.79	4.58	5.10	6.15	7.19	8.11	3.53	4.19	4.97
Suitable for material up to a specific weight of										
with stick 3.40 m	t/m³	–	–	2.2	2.0	1.8	1.5	–	–	–
with stick 11'1"	lb/yd³	–	–	3,710	3,373	3,035	2,530	–	–	–
with stick 4.50 m	t/m³	–	2.2	2.0	1.8	1.5	–	–	–	–
with stick 14'9"	lb/yd³	–	3,710	3,373	3,035	2,530	–	–	–	–
with stick 5.60 m	t/m³	2.2	2.0	1.8	1.5	–	–	–	–	–
with stick 18'4"	lb/yd³	3,710	3,373	3,035	2,530	–	–	–	–	–
with stick 6.80 m	t/m³	–	–	–	–	–	–	2.2	2.0	1.8
with stick 22'3"	lb/yd³	–	–	–	–	–	–	3,710	3,373	3,035
Cutting width	mm	1,300 ¹⁾	1,300 ¹⁾	1,400 ¹⁾	1,600 ¹⁾	1,800 ¹⁾	2,000 ¹⁾	1,350 ²⁾	1,550 ²⁾	1,750 ²⁾
	ft in	4'3" ¹⁾	4'3" ¹⁾	4'7" ¹⁾	5'2" ¹⁾	5'10" ¹⁾	6'6" ¹⁾	4'5" ²⁾	5'1" ²⁾	5'8" ²⁾
Weight	kg	3,720	4,080	4,530	4,970	5,280	5,700	3,190	3,310	3,610
	lb	8,201	8,995	9,987	10,957	11,640	12,566	7,033	7,297	7,959

¹⁾ Medium-duty bucket with teeth size V 69 SD (appropriate for materials up to classification 5, according to VOB, Section C, DIN 18300)

²⁾ Bucket R 974 B Litronic®

Lift Capacities

with Gooseneck Boom 9.20 m/30'2"

Stick 3.40 m

Height (m)	Radius of load from centerline of machine (m)									
	4.5	6.0	7.5	9.0	10.5	12.0	13.5	15.0	16.5	18.0
12.0										
10.5					12.2# (12.2#)					
9.0					12.5# (12.5#)	11.7# (11.7#)				
7.5				14.8# (14.8#)	13.1# (13.1#)	11.9# (11.9#)				
6.0		25.4# (25.4#)	19.5# (19.5#)	16.1# (16.1#)	13.8# (13.8#)	12.3# (12.3#)				
4.5			21.9# (21.9#)	17.5# (17.5#)	14.7# (14.7#)	12.9# (12.9#)	10.8# (11.5#)			
3.0			23.9# (23.9#)	18.8# (18.8#)	15.6# (15.6#)	13.1# (13.4#)	10.4# (11.7#)			
1.5			25.1# (25.1#)	19.8# (19.8#)	15.6# (16.2#)	12.5# (13.7#)	10.0# (11.9#)			
0		28.6# (28.6#)	25.1# (25.6#)	19.0# (20.2#)	14.9# (16.6#)	12.0# (13.9#)				
- 1.5	21.2# (21.2#)	32.2# (32.2#)	24.6# (25.2#)	18.5# (20.1#)	14.5# (16.5#)	11.7# (13.6#)				
- 3.0	31.6# (31.6#)	30.2# (30.2#)	24.0# (24.0#)	18.4# (19.3#)	14.4# (15.8#)	11.8# (12.7#)				
- 4.5	33.8# (33.8#)	27.1# (27.1#)	21.9# (21.9#)	17.7# (17.7#)	14.2# (14.2#)					
- 6.0	27.7# (27.7#)	22.7# (22.7#)	18.5# (18.5#)	14.7# (14.7#)						
- 7.5		16.1# (16.1#)	12.8# (12.8#)							
- 9.0										
- 10.5										
- 12.0										

Stick 4.50 m

Height (m)	Radius of load from centerline of machine (m)									
	4.5	6.0	7.5	9.0	10.5	12.0	13.5	15.0	16.5	18.0
12.0										
10.5						9.8# (9.8#)				
9.0						9.9# (9.9#)	9.5# (9.5#)			
7.5						11.2# (11.2#)	10.2# (10.2#)	9.6# (9.6#)		
6.0						14.0# (14.0#)	12.1# (12.1#)	10.8# (10.8#)	9.8# (9.8#)	
4.5			25.9# (25.9#)	19.4# (19.4#)	15.6# (15.6#)	13.2# (13.2#)	11.5# (11.5#)	10.2# (10.2#)		
3.0						21.8# (21.8#)	17.2# (17.2#)	14.2# (14.2#)	12.1# (12.1#)	10.3# (10.6#)
1.5			29.2# (29.2#)	23.7# (23.7#)	18.5# (18.5#)	15.1# (15.1#)	12.4# (12.7#)	9.8# (11.0#)		
0			28.9# (28.9#)	24.8# (24.8#)	19.1# (19.3#)	14.9# (15.7#)	11.8# (13.1#)	9.4# (11.1#)		
- 1.5	18.3# (18.3#)	33.1# (33.1#)	24.5# (25.0#)	18.3# (19.7#)	14.2# (15.9#)	11.3# (13.2#)	9.2# (11.0#)			
- 3.0	25.5# (25.5#)	31.9# (31.9#)	24.1# (24.5#)	17.9# (19.4#)	13.9# (15.7#)	11.1# (12.9#)	9.1# (10.3#)			
- 4.5	34.3# (34.3#)	29.6# (29.6#)	23.1# (23.1#)	17.9# (18.4#)	13.9# (14.8#)	11.2# (11.8#)				
- 6.0	34.0# (34.0#)	26.2# (26.2#)	20.7# (20.7#)	16.5# (16.5#)	12.9# (12.9#)					
- 7.5	26.8# (26.8#)	21.1# (21.1#)	16.7# (16.7#)	12.9# (12.9#)						
- 9.0			9.9# (9.9#)							
- 10.5										
- 12.0										

Stick 5.60 m

Height (m)	Radius of load from centerline of machine (m)									
	4.5	6.0	7.5	9.0	10.5	12.0	13.5	15.0	16.5	18.0
13.5						8.1# (8.1#)				
12.0										
10.5						8.1# (8.1#)				
9.0						8.1# (8.1#)				
7.5						8.9# (8.9#)	8.4# (8.4#)	8.0# (8.0#)		
6.0					10.7# (10.7#)	9.6# (9.6#)	8.8# (8.8#)	8.2# (8.2#)		
4.5				13.9# (13.9#)	11.8# (11.8#)	10.4# (10.4#)	9.3# (9.3#)	8.5# (8.5#)		
3.0			19.9# (19.9#)	15.7# (15.7#)	13.0# (13.0#)	11.2# (11.2#)	9.8# (9.8#)	8.3# (8.8#)		
1.5		30.6# (30.6#)	22.3# (22.3#)	17.3# (17.3#)	14.1# (14.1#)	11.9# (11.9#)	10.1# (10.3#)	7.9# (9.0#)		
0		31.3# (31.3#)	24.0# (24.0#)	18.6# (18.6#)	15.0# (15.0#)	12.0# (12.5#)	9.5# (10.7#)	7.6# (9.2#)		
- 1.5	16.5# (16.5#)	31.9# (31.9#)	24.9# (24.9#)	18.8# (19.3#)	14.5# (15.6#)	11.4# (12.9#)	9.1# (10.8#)	7.3# (9.1#)		
- 3.0	21.7# (21.7#)	33.1# (33.1#)	24.4# (25.0#)	18.1# (19.6#)	14.0# (15.8#)	11.1# (12.9#)	8.9# (10.7#)			
- 4.5	28.3# (28.3#)	31.7# (31.7#)	24.1# (24.2#)	17.8# (19.1#)	13.7# (15.4#)	10.9# (12.5#)	8.9# (10.0#)			
- 6.0	36.6# (36.6#)	29.3# (29.3#)	22.6# (22.6#)	17.8# (17.9#)	13.8# (14.3#)	11.0# (11.3#)				
- 7.5	33.7# (33.7#)	25.4# (25.4#)	19.8# (19.8#)	15.6# (15.6#)	12.1# (12.1#)					
- 9.0	25.5# (25.5#)	19.7# (19.7#)	15.2# (15.2#)	11.4# (11.4#)						
- 10.5										

Stick 6.80 m

Height (m)	Radius of load from centerline of machine (m)									
	4.5	6.0	7.5	9.0	10.5	12.0	13.5	15.0	16.5	18.0
12.0							8.8# (8.8#)			
10.5							8.7# (8.7#)	7.5# (7.5#)		
9.0							8.9# (8.9#)	8.8# (8.8#)		
7.5							9.3# (9.3#)	9.0# (9.0#)		
6.0							10.4# (10.4#)	9.8# (9.8#)	9.3# (9.3#)	7.5# (7.5#)
4.5							12.6# (12.6#)	11.4# (11.4#)	10.4# (10.4#)	9.7# (8.6#)
3.0						20.0# (20.0#)	16.4# (16.4#)	14.1# (14.1#)	12.4# (12.4#)	11.1# (10.2#)
1.5			30.9# (30.9#)	23.1# (23.1#)	18.4# (18.4#)	15.4# (15.4#)	13.3# (13.3#)	11.8# (11.8#)	9.9# (10.6#)	8.1# (9.5#)
0			34.2# (34.2#)	25.4# (25.4#)	20.1# (20.1#)	16.6# (16.6#)	14.2# (14.2#)	11.7# (12.3#)	9.5# (10.9#)	7.8# (8.9#)
- 1.5	18.0# (18.0#)	35.1# (35.1#)	27.0# (27.0#)	21.3# (21.3#)	17.0# (17.5#)	13.7# (14.8#)	11.2# (12.7#)	9.2# (11.1#)		
- 3.0	21.6# (21.6#)	36.6# (36.6#)	27.4# (27.7#)	20.7# (21.9#)	16.3# (18.0#)	13.1# (15.1#)	10.8# (12.9#)	9.0# (11.0#)		
- 4.5	26.6# (26.6#)	36.0# (36.0#)	26.7# (27.6#)	20.1# (22.0#)	15.8# (18.0#)	12.8# (15.0#)	10.6# (12.6#)	8.9# (10.4#)		
- 6.0	32.9# (32.9#)	34.4# (34.4#)	26.6# (26.6#)	19.9# (21.3#)	15.7# (17.4#)	12.7# (14.4#)	10.6# (11.7#)			
- 7.5	41.2# (41.2#)	31.5# (31.5#)	24.6# (24.6#)	19.8# (19.8#)	15.8# (16.0#)	12.9# (12.9#)				
- 9.0	35.7# (35.7#)	27.0# (27.0#)	21.3# (21.3#)	16.9# (16.9#)	13.2# (13.2#)					
- 10.5	26.1# (26.1#)	20.2# (20.2#)	15.7# (15.7#)	11.7# (11.7#)						
- 12.0										

The load values are quoted in tons (t) on the backhoe bucket's load hook, and may be swung 360° on firm and even ground. Values quoted in brackets apply to the undercarriage when in longitudinal position. Capacities are valid for 600 mm wide double grouser pads. Indicated loads are based on ISO 10567 standard and do not exceed 75 % of tipping or 87 % of hydraulic capacity (indicated via #). Maximum load for the backhoe bucket's lifting eye is 27 t. Without bucket (3.90 m³/2.70 m³*), the lift capacities will increase by 4,530 kg/3,190 kg*, without bucket cylinder, link and lever they increase by an additional 1,900 kg/1,100 kg*. Lifting capacity of the excavator is limited by machine stability, hydraulic capacity and maximum permissible load of the load hook.

When lifting loads, the hydraulic excavator must be equipped with automatic check valve on its hoist cylinders and overload warning device according to European Standard, EN 474-5.

* Just for stick 6.80 m

Backhoe Attachment

with Gooseneck Boom 11.00 m/36'

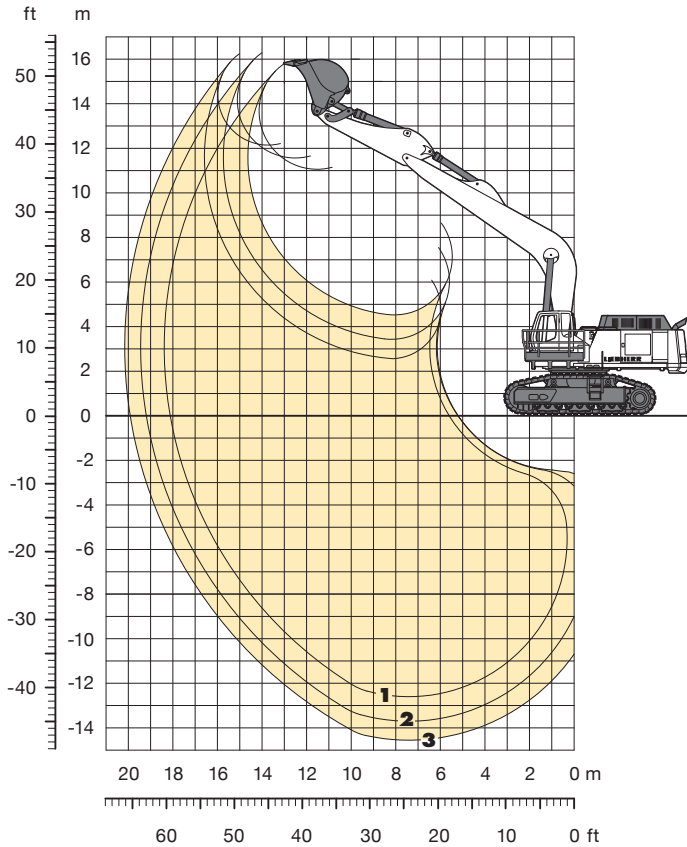

Digging Envelope

		1	2	3*
Stick lengths	m	4.50	5.60	6.80
	ft in	14'9"	18'4"	22'3"
Max. digging depth	m	12.50	13.60	14.45
	ft in	41'	44'7"	47'4"
Max. reach at ground level	m	18.15	19.20	20.00
	ft in	59'6"	62'11"	65'7"
Max. dump height	m	11.25	11.80	12.65
	ft in	36'10"	38'8"	41'5"
Max. teeth height	m	16.05	16.60	16.80
	ft in	52'7"	54'5"	55'1"
Max. digging force (SAE)	kN	346	300	273
	lbf	77,784	67,443	61,373
Max. breakout force (SAE)	kN	550	550	405
	lbf	123,645	123,645	91,048

* with stick 6.80 m with R 974 B Litronic® buckets

Operating Weight and Ground Pressure

The operating weight includes the basic machine with gooseneck boom 11.00 m/36', stick 5.60 m/18'4" and bucket 2.90 m³/3.8 yd³.

Undercarriage		HD	
Pad width	mm/ft in	600/1'11"	750/2'5"
Weight	kg/lb	122,200/269,405	123,400/272,050
Ground pressure	kg/cm²/psi	1.83/26.03	1.48/21.05

Buckets

Capacity ISO 7451	m³	2.90	3.50	3.90	4.70	2.70	3.20
	yd³	3.79	4.58	5.10	6.15	3.53	4.19
Suitable for material up to a specific weight of							
with stick 4.50 m	t/m³	2.2	1.8	1.6	1.2	–	–
with stick 14'9"	lb/yd³	3,710	3,035	2,698	2,024	–	–
with stick 5.60 m	t/m³	2.0	1.6	1.2	–	–	–
with stick 18'4"	lb/yd³	3,373	2,698	2,024	–	–	–
with stick 6.80 m	t/m³	–	–	–	–	2.2	1.8
with stick 22'2"	lb/yd³	–	–	–	–	3,710	3,035
Cutting width	mm	1,300 ¹⁾	1,300 ¹⁾	1,400 ¹⁾	1,600 ¹⁾	1,350 ²⁾	1,550 ²⁾
	ft in	4'3" ¹⁾	4'3" ¹⁾	4'7" ¹⁾	5'2" ¹⁾	4'5" ²⁾	5'1" ²⁾
Weight	kg	3,720	4,080	4,530	4,970	3,190	3,310
	lb	8,201	8,995	9,987	10,957	7,033	7,297

¹⁾ Medium-duty bucket with teeth size V 69 SD (appropriate for materials up to classification 5, according to VOB, Section C, DIN 18300)

²⁾ Bucket R 974 B Litronic®

Lift Capacities

with Gooseneck Boom 11.00 m/36'

Stick 4.50 m

Height (m)	Radius of load from centerline of machine (m)									
	4.5	6.0	7.5	9.0	10.5	12.0	13.5	15.0	16.5	18.0
12.0							5.5# (5.5#)			
10.5							5.5# (5.5#)	5.5# (5.5#)		
9.0							5.7# (5.7#)	5.4# (5.4#)		
7.5						6.8# (6.8#)	6.1# (6.1#)	5.6# (5.6#)		
6.0				10.7# (10.7#)	8.7# (8.7#)	7.4# (7.4#)	6.5# (6.5#)	5.9# (5.9#)	5.6# (5.6#)	
4.5				12.2# (12.2#)	9.7# (9.7#)	8.1# (8.1#)	7.0# (7.0#)	6.2# (6.2#)	5.7# (5.7#)	
3.0				13.6# (13.6#)	10.7# (10.7#)	8.8# (8.8#)	7.5# (7.5#)	6.6# (6.6#)	6.0# (6.0#)	
1.5				14.8# (14.8#)	11.6# (11.6#)	9.5# (9.5#)	8.0# (8.0#)	6.9# (6.9#)	6.1# (6.2#)	
0			20.7# (20.7#)	15.7# (15.7#)	12.4# (12.4#)	10.1# (10.1#)	8.4# (8.4#)	7.2# (7.2#)		
- 1.5			21.0# (21.0#)	16.2# (16.2#)	12.9# (12.9#)	10.5# (10.5#)	8.7# (8.8#)	7.1# (7.4#)		
- 3.0	13.0# (13.0#)	20.3# (20.3#)	20.9# (20.9#)	16.3# (16.3#)	13.1# (13.1#)	10.4# (10.7#)	8.5# (8.9#)	7.0# (7.4#)		
- 4.5	19.9# (19.9#)	26.3# (26.3#)	20.4# (20.4#)	16.1# (16.1#)	13.0# (13.0#)	10.4# (10.6#)	8.5# (8.8#)			
- 6.0	27.7# (27.7#)	24.7# (24.7#)	19.4# (19.4#)	15.5# (15.5#)	12.5# (12.5#)	10.2# (10.2#)	8.2# (8.2#)			
- 7.5	29.2# (29.2#)	22.4# (22.4#)	17.8# (17.8#)	14.3# (14.3#)	11.5# (11.5#)	9.1# (9.1#)				
- 9.0	24.5# (24.5#)	19.1# (19.1#)	15.3# (15.3#)	12.2# (12.2#)	9.5# (9.5#)					
- 10.5		14.2# (14.2#)	11.2# (11.2#)	8.2# (8.2#)						
- 12.0										

Stick 5.60 m

Height (m)	Radius of load from centerline of machine (m)									
	4.5	6.0	7.5	9.0	10.5	12.0	13.5	15.0	16.5	18.0
12.0										4.4# (4.4#)
10.5										4.3# (4.3#)
9.0										4.5# (4.5#)
7.5										4.4# (4.4#)
6.0									5.1# (5.1#)	4.7# (4.7#)
4.5									5.6# (5.6#)	5.1# (5.1#)
3.0									6.4# (6.4#)	5.6# (5.6#)
1.5									10.8# (10.8#)	8.7# (8.7#)
0									12.4# (12.4#)	9.8# (9.8#)
- 1.5									18.6# (18.6#)	13.8# (13.8#)
- 3.0	11.0# (11.0#)	17.8# (17.8#)	21.1# (21.1#)	16.2# (16.2#)	12.8# (12.8#)	10.4# (10.4#)	8.4# (8.6#)	6.8# (7.2#)	5.6# (6.0#)	4.9# (5.5#)
- 4.5	16.2# (16.2#)	23.4# (23.4#)	20.9# (20.9#)	16.3# (16.3#)	13.0# (13.0#)	10.3# (10.5#)	8.3# (8.7#)	6.7# (7.2#)		
- 6.0	22.2# (22.2#)	26.6# (26.6#)	20.3# (20.3#)	16.0# (16.0#)	12.8# (12.8#)	10.3# (10.4#)	8.3# (8.5#)	6.8# (6.8#)		
- 7.5	29.4# (29.4#)	24.8# (24.8#)	19.2# (19.2#)	15.2# (15.2#)	12.2# (12.2#)	9.8# (9.8#)	7.8# (7.8#)			
- 9.0	29.7# (29.7#)	22.2# (22.2#)	17.3# (17.3#)	13.8# (13.8#)	10.9# (10.9#)	8.5# (8.5#)				
- 10.5	24.2# (24.2#)	18.4# (18.4#)	14.4# (14.4#)	11.3# (11.3#)	8.5# (8.5#)					
- 12.0		12.6# (12.6#)	9.5# (9.5#)							

Stick 6.80 m

Height (m)	Radius of load from centerline of machine (m)									
	4.5	6.0	7.5	9.0	10.5	12.0	13.5	15.0	16.5	18.0
12.0										5.6# (5.6#)
10.5										5.5# (5.5#)
9.0										5.6# (5.6#)
7.5									6.0# (6.0#)	5.8# (5.7#)
6.0									6.9# (6.9#)	6.4# (6.0#)
4.5									8.6# (8.6#)	7.6# (6.9#)
3.0									17.6# (17.6#)	13.7# (13.7#)
1.5									20.0# (20.0#)	15.4# (15.4#)
0									21.9# (21.9#)	16.8# (16.8#)
- 1.5									15.3# (15.3#)	23.1# (23.1#)
- 3.0	11.7# (11.7#)	18.5# (18.5#)	23.8# (23.8#)	18.6# (18.6#)	15.0# (15.0#)	12.5# (12.5#)	10.5# (10.6#)	8.8# (9.2#)	7.4# (8.0#)	6.3# (7.0#)
- 4.5	15.9# (15.9#)	22.8# (22.8#)	24.1# (24.1#)	19.0# (19.0#)	15.4# (15.4#)	12.8# (12.8#)	10.2# (10.8#)	8.6# (9.3#)	7.3# (8.0#)	
- 6.0	20.6# (20.6#)	28.1# (28.1#)	23.8# (23.8#)	18.9# (18.9#)	15.4# (15.4#)	12.8# (12.8#)	10.1# (10.8#)	8.5# (9.2#)		
- 7.5	26.3# (26.3#)	29.7# (29.7#)	23.0# (23.0#)	18.5# (18.5#)	15.1# (15.1#)	12.3# (12.6#)	10.2# (10.5#)	8.7# (8.7#)		
- 9.0	33.2# (33.2#)	27.6# (27.6#)	21.6# (21.6#)	17.4# (17.4#)	14.3# (14.3#)	11.8# (11.8#)	9.6# (9.6#)			
- 10.5	32.6# (32.6#)	24.6# (24.6#)	19.4# (19.4#)	15.6# (15.6#)	12.7# (12.7#)	10.1# (10.1#)				
- 12.0	26.1# (26.1#)	20.0# (20.0#)	15.8# (15.8#)	12.5# (12.5#)	9.5# (9.5#)					

The load values are quoted in tons (t) on the backhoe bucket's load hook, and may be swung 360° on firm and even ground. Values quoted in brackets apply to the undercarriage when in longitudinal position. Capacities are valid for 600 mm wide double grouser pads. Indicated loads are based on ISO 10567 standard and do not exceed 75 % of tipping or 87 % of hydraulic capacity (indicated via #). Maximum load for the backhoe bucket's lifting eye is 27 t. Without bucket (3.90 m³/2.70 m³*), the lift capacities will increase by 4,530 kg/3,190 kg*, without bucket cylinder, link and lever they increase by an additional 1,900 kg/1,100 kg*. Lifting capacity of the excavator is limited by machine stability, hydraulic capacity and maximum permissible load of the load hook.

When lifting loads, the hydraulic excavator must be equipped with automatic check valve on its hoist cylinders and overload warning device according to European Standard, EN 474-5.

* Just for stick 6.80 m

Shovel Attachment

with Shovel Boom 5.40 m/17'8"

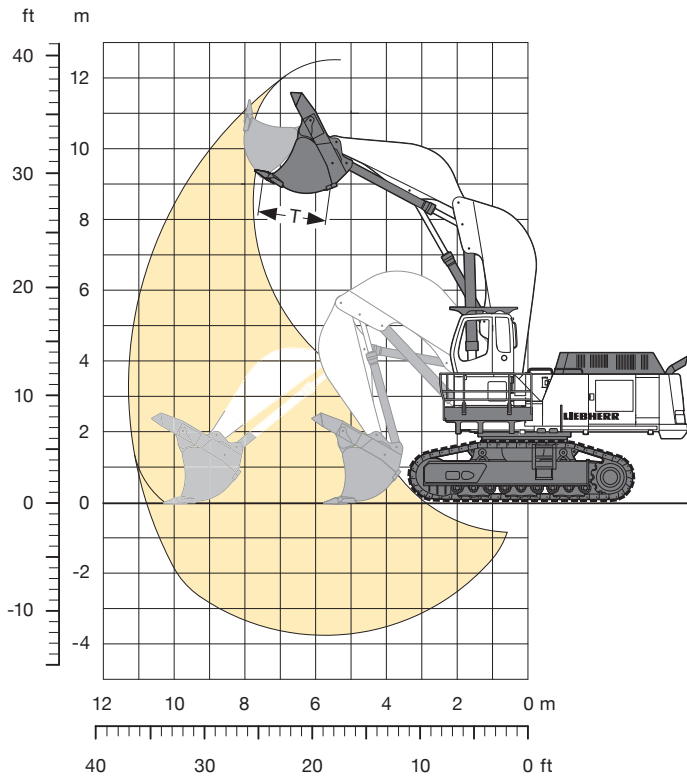

Digging Envelope

Stick length	3.90 m/12'9"
Max. reach at ground level	10.80 m/35'5"
Max. dump height	8.90 m/29'2"
Max. crowd length	4.50 m/14'9"
Bucket opening width T	1,900 mm/ 6'2"
Max. crowd force at ground level (SAE)	550 kN/123,645 lbf
Max. crowd force (SAE)	750 kN/168,607 lbf
Max. breakout force (SAE)	550 kN/123,645 lbf

Operating Weight and Ground Pressure

The operating weight includes the basic machine with shovel attachment and a 7.00 m³/9.16 yd³ bucket.

Undercarriage		HD	
Pad width	mm/ft in	600/1'11"	750/2'5"
Weight	kg/lb	125,100/275,798	126,300/278,444
Ground pressure	kg/cm ² /psi	1.88/26.74	1.48/21.05

Bottom Dump Buckets

For materials classe according to VOB, Section C, DIN 18300		< 5	< 5	5 – 6	5 – 6	5 – 6	7 – 8	7 – 8	7 – 8
Typical operation according to VOB, Section C, DIN 18300		GP	GP	HD	HD	HD	XHD	XHD	XHD
Capacity ISO 7546	m ³	9.00	7.70	7.70	7.00	5.70	7.00	7.00	5.70
	yd ³	11.77	10.07	10.07	9.16	7.46	9.16	9.16	7.46
Suitable for material up to a specific weight of	t/m ³	1.3	1.7	1.5	1.8	2.3	1.5	1.8	2.2
	lb/yd ³	2,192	2,867	2,530	3,035	3,879	2,530	3,035	3,710
Cutting width	mm	2,900	2,900	2,900	2,900	2,500	2,900	2,900	2,500
	ft in	9'6"	9'6"	9'6"	9'6"	8'2"	9'6"	9'6"	8'2"
Weight	kg	13,300	11,000	13,300	12,900	11,400	14,400	12,600	12,400
	lb	29,321	24,251	29,321	28,440	25,133	31,747	27,778	27,337
Wear kit level		I	I	II	II	II	III	III	III

GP: General purpose bucket with Esco V 69 RYL teeth

HD: Heavy-duty bucket with Esco V 69 RYL teeth

XHD: Heavy-duty rock bucket with Esco V 69 RYL teeth

Level I: For non-abrasive materials, such as limestone, without flint inclusion, shot material or easily breakable rock, i.e., deteriorated rock, soft limestone, shale, etc.

Level II: For preblasted heavy rock, or deteriorated, cracked material (classification 5 to 6, according to DIN 18300)

Level III: For highly-abrasive materials such as rock with a high silica content, sandstone etc.

Component Dimensions and Weights

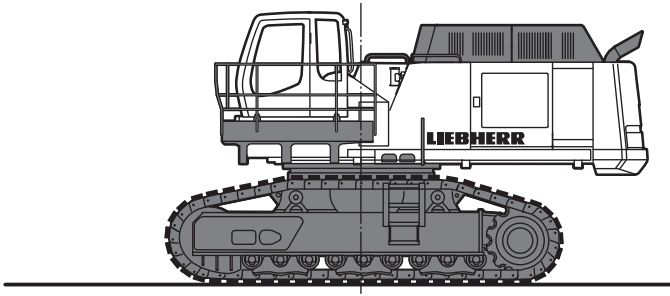

Basic Machine (with Catwalks)

Track pads	mm/ft in	600/1'11"	750/2'5"
Weight with counterweight	kg/lb	89,140/196,520	90,330/199,143

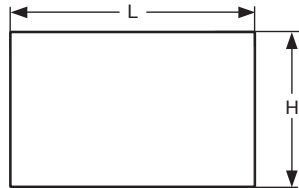

Catwalks and Railings (Wooden Crate)

L Length	mm/ft in	3,500/11' 5"
H Height	mm/ft in	2,400/ 7'10"
Width	mm/ft in	1,900/ 6' 2"
Weight	kg/lb	1,800/3,968

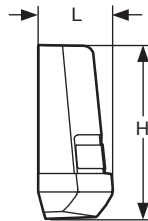

Counterweight

L Length	mm/ft in	900/ 2'11"	900/ 2'11"*
H Height	mm/ft in	1,800/ 5'10"	1,800/ 5'10"*
Width	mm/ft in	4,050/13' 3"	4,050/13' 3"*
Weight	kg/lb	19,020/ 41,932	22,000/ 48,502*

* only with 11.00 m/36' gooseneck boom

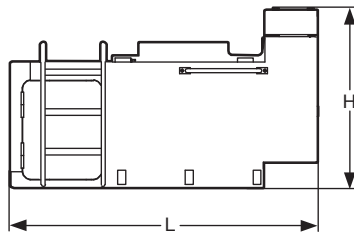

Cab Elevation

L Length	mm/ft in	1,950/6'4"
H Height	mm/ft in	1,130/3'8"
Width	mm/ft in	1,250/4'1"
Weight	kg/lb	600/1,323

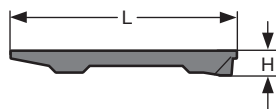

Protective Grid Up

L Length	mm/ft in	1,730/5'8"
H Height	mm/ft in	185/ 7"
Width	mm/ft in	950/3'1"
Weight	kg/lb	30/66

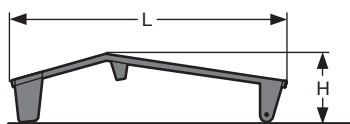

Front Window Screen

L Length	mm/ft in	1,970/6'5"
H Height	mm/ft in	500/1'7"
Width	mm/ft in	970/3'2"
Weight	kg/lb	45/99

Component Dimensions and Weights

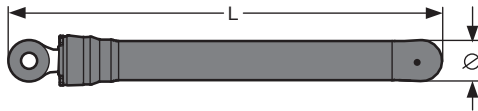

Backhoe Hoist Cylinder (two)

L Length	mm/ft in	3,300/10'9"
Ø Diameter	mm/ft in	400/ 1'3"
Weight	kg/lb	2 x 1,330/2 x 2,932

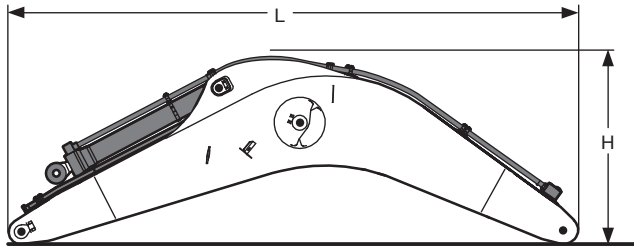

Gooseneck Boom with Stick Cylinder

Boom length	m	7.80	9.20	11.00
	ft in	25'7"	30'2"	36'
L Length	mm	8,200	9,600	11,400
	ft in	26'10"	31'5"	37'4"
H Height	mm	2,800	2,800	3,250
	ft in	9'2"	9'2"	10'7"
Width	mm	1,600	1,600	1,600
	ft in	5'2"	5'2"	5'2"
Weight	kg	13,345	14,285	15,810
	lb	29,421	31,493	34,855

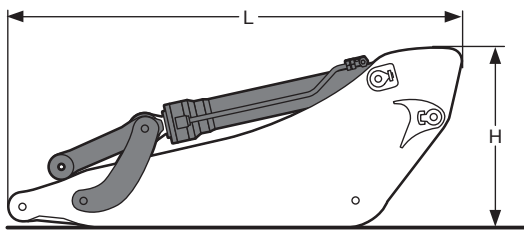

Stick with Bucket Cylinder

Stick length	m	3.40	4.50	5.60	6.80
	ft in	11'1"	14'9"	18'4"	22'3"
L Length	mm	4,800	5,700	6,800	8,000
	ft in	15'8"	18'8"	22'3"	26'2"
H Height	mm	1,850	1,650	1,550	1,400
	ft in	6'	5'4"	5'1"	4'7"
Width	mm	945	945	945	945
	ft in	3'1"	3'1"	3'1"	3'1"
Weight	kg	7,400	7,730	7,885	6,600
	lb	16,314	17,042	17,383	14,550

Mining Backhoe Buckets for Boom 7.80 m/25'7"

Application		GP	GP	GP
Capacity ISO 7451	m ³	8.00	7.30	6.70
	yd ³	10.46	9.55	8.76
L Length	mm	2,900	2,800	2,800
	ft in	9'6"	9'2"	9'2"
H Height	mm	2,250	2,200	2,200
	ft in	7'4"	7'2"	7'2"
Width	mm	2,600	2,400	2,250
	ft in	8'6"	7'10"	7'4"
Weight	kg	7,200	6,800	6,600
	lb	15,873	14,991	14,550

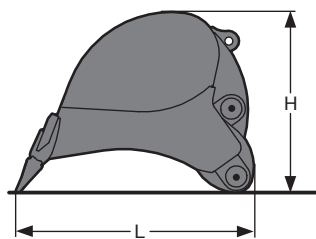

Application		HD	HD	HD
Capacity ISO 7451	m ³	7.70	7.00	6.40
	yd ³	10.07	9.16	8.37
L Length	mm	3,100	2,900	3,000
	ft in	10'2"	9'6"	9'10"
H Height	mm	2,300	2,200	2,150
	ft in	7'6"	7'2"	7'
Width	mm	2,550	2,400	2,250
	ft in	8'4"	7'10"	7'4"
Weight	kg	7,700	7,500	7,200
	lb	16,976	16,535	15,873

Component Dimensions and Weights

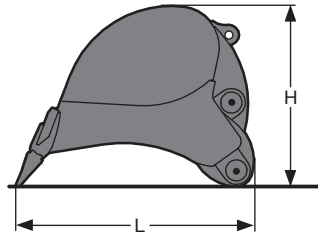

Mining Backhoe Buckets for Boom 7.80 m/25'7"

Application		XHD	XHD	XHD
Capacity ISO 7451	m ³	6.70	6.20	5.80
	yd ³	8.76	8.11	7.59
L Length	mm	3,100	3,150	2,950
	ft in	10'2"	10'3"	9'8"
H Height	mm	2,200	2,200	2,200
	ft in	7'2"	7'2"	7'2"
Width	mm	2,600	2,500	2,500
	ft in	8'6"	8'2"	8'2"
Weight	kg	9,300	9,000	8,200
	lb	20,503	19,842	18,078

Backhoe Buckets

for Boom 9.20 m/30'2" and 11.00 m/36'

Capacity ISO 7451	m ³	2.90	3.50	3.90
	yd ³	3.79	4.58	5.10
L Length	mm	2,700	2,900	2,900
	ft in	8'10"	9'6"	9'6"
H Height	mm	2,100	2,250	2,250
	ft in	6'10"	7'4"	7'4"
Width	mm	1,300	1,300	1,400
	ft in	4'3"	4'3"	4'7"
Weight	kg	3,720	4,080	4,530
	lb	8,201	8,995	9,987

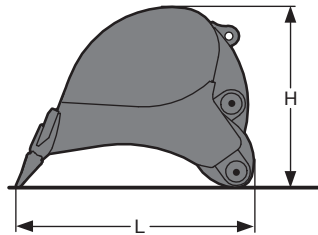

Capacity ISO 7451	m ³	4.70	5.50	6.20
	yd ³	6.15	7.19	8.11
L Length	mm	2,900	2,900	2,900
	ft in	9'6"	9'6"	9'6"
H Height	mm	2,250	2,250	2,250
	ft in	7'4"	7'4"	7'4"
Width	mm	1,600	1,800	2,000
	ft in	5'2"	5'10"	6'6"
Weight	kg	4,970	5,280	5,700
	lb	10,957	11,640	12,566

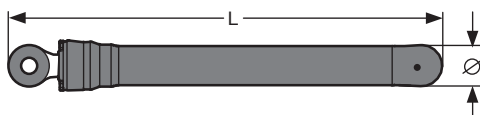

Shovel Hoist Cylinder (two)

L Length	mm/ft in	3,300/10'9"
Ø Diameter	mm/ft in	400/ 1'3"
Weight	kg/lb	2 x 1,330/2 x 2,932

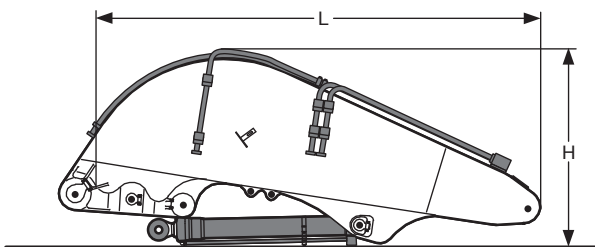

Shovel Boom

L Length	mm/ft in	5,800/19'
H Height	mm/ft in	2,400/ 7'10"
Width	mm/ft in	1,800/ 5'10"
Weight without crowd cylinder	kg/lb	11,090/24,449
Weight crowd cylinder	kg/lb	563/1,241

Component Dimensions and Weights

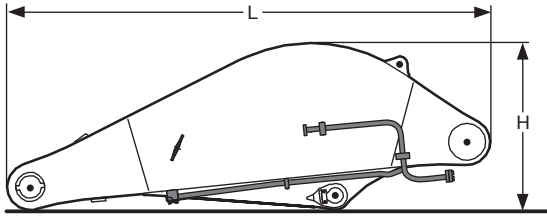

Shovel Stick

L Length	mm/ft in	4,350/14' 3"
H Height	mm/ft in	1,500/ 4'11"
Width	mm/ft in	1,900/ 6' 2"
Weight	kg/lb	6,130/13,514

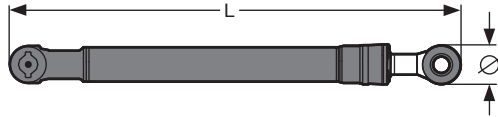

Shovel Bucket Cylinder (two)

L Length	mm/ft in	3,350/10'11"
Ø Diameter	mm/in	300/ 11"
Weight	kg/lb	2 x 810/2 x 1,786

Bottom Dump Buckets for Boom 5.40 m/17'8"

Capacity ISO 7451	m ³	5.70	7.00	7.70	9.00
	yd ³	7.46	9.16	10.07	11.77
L Length	mm	2,800	2,800	2,850	3,250
	ft in	9'2"	9'2"	9'4"	10'7"
H Height	mm	2,900	3,000	3,000	3,050
	ft in	9'6"	9'10"	9'10"	10'
Width	mm	2,500	2,900	2,900	2,900
	ft in	8'2"	9'6"	9'6"	9'6"
Weight					
Wear kit level I	kg	–	–	11,000	13,300
	lb	–	–	24,251	29,321
Wear kit level II	kg	11,400	12,800	13,300	–
	lb	25,133	28,219	29,321	–
Wear kit level III	kg	12,400	14,400	–	–
	lb	27,337	31747	–	–

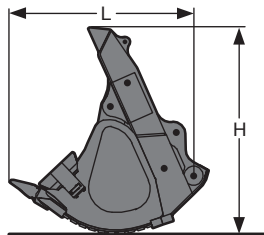

Equipment



Undercarriage

Three track guides per track	•
Integrated travel drive	•
Digging locks	•
Different undercarriage versions	+
Different track pad width	+



Uppercarriage

Engine hood with lift help	•
Lockable tool box	•
Handrails, non slip surfaces	•
Tool kit	•
Maintenance-free swing brake lock	•
Maintenance-free HD-batteries	•
Sound insulation	•
Electric fuel tank filler pump	+
Pedal controlled positioning swing brake	+
Customized paint – compl. machine	+
Protection for front working light	+
Heavy counterweight	+



Hydraulics

Electronic pump regulation	•
Stepless work mode selector	•
Pressure storage for controlled lowering of attachments with engine turned off	•
Hydraulic tank shut-off valve	•
Pressure compensation	•
Flow compensation	•
Filter with integrated fine filter area (5 µm)	•
Pressure test ports	•
Additional hydraulic circuits	+
Bio-degradable hydraulic oils	+
Filter for secondary circuit	+



Engine

Direct injection	•
Turbo charger	•
Air filter with pre-cleaner, main and safety element	•
Air filter with automatic dust ejector	•
Automatic idling	•
Main switch for electric circuit	•
Cold start aid	•
Fuel pre-heater	+



Operator's Cab

Profile and deep drawn component	•
Tinted side windows	•
Armored windshield	•
Door with sliding window	•
Washer and wiper	•
6-way adjustable cloth suspension seat	•
Seat and consoles independently adjustable	•
Coat hook	•
Dome light	•
Sun blinds	•
Radio installation prep-kit	•
Removable handle for travel pedals	•
Cigar lighter and ashtray	•
Removable custom floor mat	•
Storage and literature tray	•
Digital instrumentation	•
Digital instruments for oil temp. engine RPM and oil pressure	•
Digital hour meter visible from outside	•
Automatic air conditioning system	•
AM/FM stereo radio with USB connection	+
Air power seat adjustment with heating	+
Warning beacon	+
Additional flood lights	+
Bluetooth connection for mobile phone	+



Attachment

Cylinders with shock absorber	•
Sealed pivots	•
Two flood lights on the boom	•
Bucket mounted 27 t lifting eye	•
Automatic lubrication system Lincoln "Centromatic" for attachment and swing ring	•
Safety check valves on the hoist cylinders (only on 528 series)	•
Overload warning device	+
Hydraulic quick change tool adapter	+
Liebherr equipment program	+
Special buckets	+
Cylinder – rod protection	+
Additional piping for hydraulic tools	+
3,40 m/11'1" stick equipped for additional pipings	+

• = Standard, + = Option

Options and/or special attachments, supplied by vendors other than Liebherr, are only to be installed with the knowledge and approval of Liebherr to retain warranty.

Liebherr-France SAS Mining Division

49 rue Frédéric Hartmann, CS 50038, F-68025 Colmar Cedex

☎ +33 369 4921 99, Fax +33 369 4922 79

www.liebherr.com, E-Mail: info.lfr-mining@liebherr.com