



## RX 60 Technical data.

Electric forklift trucks

---

RX 60-40

---

RX 60-45

---

RX 60-50

---

RX 60-50/600

---



This specification sheet to VDI Guidelines 2198 only gives the technical figures for the standard truck.  
Different tyres, other masts, additional equipment etc. could give different figures.

		STILL	STILL	STILL	STILL		
Characteristics	1.1	Manufacturer					
	1.2	Manufacturer's model designation	RX 60-40	RX 60-45	RX 60-50	RX 60-50/600	
	1.3	Truck type	Electric	Electric	Electric	Electric	
	1.4	Operation	Rider seated	Rider seated	Rider seated	Rider seated	
	1.5	Capacity	Q t	4.0	4.5	4.99	4.99
	1.6	Load centre	c mm	500	500	500	600
	1.8	Load distance	x mm	525	525	525	535
	1.9	Wheel base	y mm	2021	2021	2021	2088
	Weights	2.1	Truck weight	kg	6477	6793	7115
2.2		Axle load, laden, front	kg	9296	10112	10884	11547
2.2.1		Axle load, laden, rear	kg	1181	1181	1221	1154
2.3		Axle load, unladen, front	kg	3268	3329	3363	3845
2.3.1		Axle load, unladen, rear	kg	3209	3463	3752	3866
Wheel   chassis	3.1	Tyres		SE	SE	SE	SE
	3.2	Tyre size, front		250-15	28 x 12.5-15	28 x 12.5-15	28 x 12.5-15
	3.3	Tyre size, rear		21 x 8-9	21 x 8-9	21 x 8-9	21 x 8-9
	3.5	Number of wheels front (x=driven)		2x	2x	2x	2x
	3.5.1	Number of wheels rear (x=driven)		2	2	2	2
	3.6	Track width, front	b <sub>10</sub> mm	1030	1104	1104	1104
	3.7	Track width, rear	b <sub>11</sub> mm	920	920	920	920
Basic dimensions	4.1	Tilt Mast/Fork carriage, forward	°	3	3	3	3
	4.1.1	Tilt Mast/Fork carriage, back	°	9	9	9	6
	4.2	Height, mast lowered	h <sub>1</sub> mm	2300	2300	2300	2300
	4.3	Free lift	h <sub>2</sub> mm	160	160	160	160
	4.4	Lift	h <sub>3</sub> mm	2980	2980	2980	2780
	4.5	Height, mast raised	h <sub>4</sub> mm	3987	3987	3987	3935
	4.7	Height over overhead guard (cab)	h <sub>6</sub> mm	2322	2320	2320	2320
	4.8	Seat/Platform height (SRP)	h <sub>7</sub> mm	1251	1249	1249	1249
	4.12	Coupling height	h <sub>10</sub> mm	546/421	546/421	546/421	546/421
	4.19	Overall length	l <sub>1</sub> mm	3886	3886	3886	4163
	4.20	Length including fork backs l <sub>2</sub>	l <sub>2</sub> mm	2886	2886	2886	2963
	4.21	Overall width	b <sub>1</sub> mm	1256	1399	1399	1399
	4.22	Fork thickness	s mm	50	50	50	60
	4.22.1	Fork width	e mm	120	120	150	130
	4.22.2	Fork length	l mm	1000	1000	1000	1200
	4.23	Fork carriage DIN 15173, Class/Form A, B		3 A	3 A	3 A	3 A
	4.24	Fork carriage width	b <sub>3</sub> mm	1200	1310	1310	1310
	4.31	Floor clearance under mast, laden	m <sub>1</sub> mm	150	150	150	150
	4.32	Floor clearance, centre of wheel-base	m <sub>2</sub> mm	147	145	145	145
	4.33	Working aisle - 1000 x 1200 pallet crosswise	A <sub>st</sub> mm	4208	4208	4208	4284
4.34	Working aisle - 800 x 1200 pallet lengthways	A <sub>st</sub> mm	4408	4408	4408	4484	
4.35	Turning radius	W <sub>a</sub> mm	2483	2483	2483	2549	
4.36	Smallest pivot point distance	b <sub>13</sub> mm	629	629	629	638	
Performance data	5.1	Travel speed laden	km/h	19	19	19	18
	5.1.1	Travel speed unladen	km/h	20	20	20	19
	5.2	Hoist speed laden	m/s	0.40	0.38	0.33	0.31
	5.2.1	Hoist speed unladen	m/s	0.55	0.46	0.46	0.44
	5.3	Lowering speed laden	m/s	0.55	0.55	0.55	0.55
	5.3.1	Lowering speed unladen	m/s	0.46	0.46	0.46	0.46
	5.5	Drawbar pull laden	N	3770	3620	3600	3600
	5.5.1	Drawbar pull unladen	N	4390	4470	4400	4400
	5.6	Max. drawbar pull laden	N	15940	15830	15670	15670
	5.6.1	Max. drawbar pull unladen	N	16140	16150	16090	16090
	5.7	Gradeability laden	%	11.3	9.5	8.8	7.4
	5.7.1	Gradeability unladen	%	17.0	16.8	15.8	13.7
	5.8	Max. gradeability laden	%	15.5	14.3	13.2	12.6
	5.8.1	Max. gradeability unladen	%	25.9	24.6	23.4	21.4
5.9	Acceleration time laden	s	5.1	5.2	5.3	5.4	
5.9.1	Acceleration time unladen	s	4.5	4.5	4.6	4.7	
5.10	Service brake		electr./mech.	electr./mech.	electr./mech.	electr./mech.	
E-Motor	6.1	Drive motor, 60 minute rating	kW	15	15	15	15
	6.2	Hoist motor 15% rating	kW	25	25	25	25
	6.3	Battery to DIN 43531/35/36 A, B, C, No		DIN 43536 A	DIN 43536 A	DIN 43536 A	DIN 43536 A
	6.4	Battery voltage	U V	80	80	80	80
	6.4.1	Battery capacity	K <sub>s</sub> Ah	840	840	840	840
	6.5	Battery weight	kg	2178	2178	2178	2178
	6.6	Energy consumption 60 CDI cycles/hour	kWh/h	10.2	10.8	11.5	12.1
Miscellaneous	8.1	Drive control					
	8.2	Working pressure for attachments	bar	250	250	250	250
	8.3	Oil flow for attachments	l/min	30	30	30	30
	8.4	Sound level at driver's ear	dB(A)	< 70	< 70	< 70	< 70
	8.5	Towing coupler, Type/Model DIN		Pin	Pin	Pin	Pin

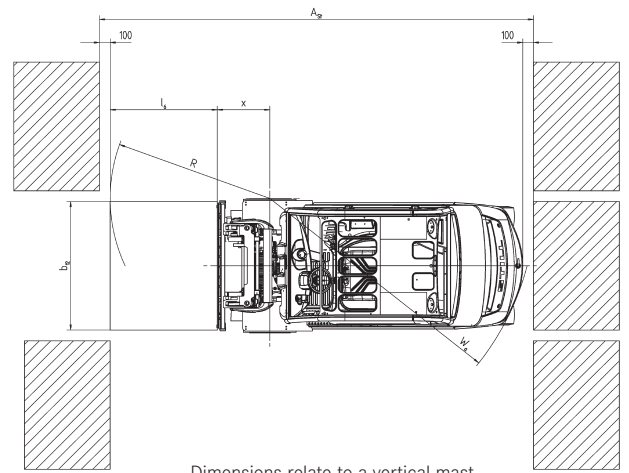
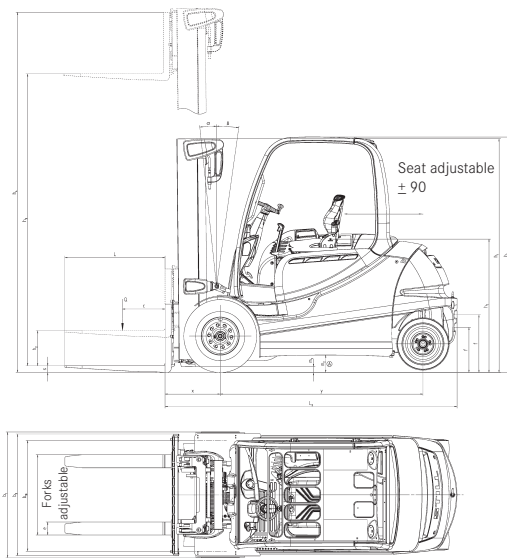

Dimensions relate to a vertical mast.

			Telescopic mast		Triplex mast	
RX 60-40/45/50	Rated lift	h <sub>3</sub> mm	2980 - 3680	4080 - 4880	4330 - 7180	
	Overall height	h <sub>1</sub> mm	2300 - 2650	2850 - 3250	2250 - 3200	
	Free lift Form "B"	h <sub>5</sub> mm	160	160	1462 - 2412	
	Free lift Form "A"	h <sub>5</sub> mm	160	160	1504 - 2554	
	Greatest height Form "B"	h <sub>4</sub> mm	3987 - 4687	5087 - 5887	5416 - 8266	
	Greatest height Form "A"	h <sub>4</sub> mm	3987 - 4687	5087 - 5887	5437 - 8287	
	Forward tilt	a °	3			
	Back tilt	b °	9			
	Overall length	L <sub>2</sub> mm	2886			
	Load distance	x mm	525			
Working aisle width	A <sub>st</sub> mm	(1000 x 1200) 4208 // (1200 x 800) 4408				
RX 60-40	Tyres	v/h	250/70-15 // 200/75-9		345/45-15 // 200/75-9	
	Track	v/h mm	1030 // 920		1104 // 920	
	Greatest width	B mm	1256		1399	
	Fork locations, centre to centre	mm	191 368 572 673 876 978			
RX 60-45/50	Tyres	v/h	345/45-15 // 200/75-9			
	Track	v/h mm	1104 // 920			
	Greatest width	B mm	1399			
	Fork locations, centre to centre	mm	191 368 572 673 978 1080			
RX 60-50/600	Rated lift	h <sub>3</sub> mm	2780 - 4680	4030 - 6880		
	Overall height	h <sub>1</sub> mm	2300 - 3250	2250 - 3200		
	Free lift Form "A"	h <sub>5</sub> mm	160	160	1230 - 2180	
	Greatest height Form "A"	h <sub>4</sub> mm	3887 - 5787	5095 - 7945		
	Forward tilt	a °	3			
	Back tilt	b °	6			
	Overall length	L <sub>2</sub> mm	2963			
	Load distance	x mm	535			
	Working aisle width	A <sub>st</sub> mm	(1000 x 1200) 4248 // (1200 x 800) 4500			

### Gradients, maximum distance that can be driven in 60 minutes

Example: An RX 60-40 with a load of 4,000 kg and a gradient of 13% can drive a distance of 215m 10 times per hour.

Unladen		RX 60-40	RX 60-45	RX 60-50	RX 60-50/600
	23%	1850 m	1470 m	1430 m	-
	20%	2700 m	2290 m	2030 m	1850
	15%	5390 m	5060 m	4350 m	4140
	10%	7180 m	6930 m	6700 m	6250
	5%	11660 m	11170 m	10720 m	10260
Laden	13%	2150 m	1590 m	1380 m	-
	9%	5030 m	4200 m	3620 m	3440
	7%	6070 m	5750 m	5380 m	5150
	5%	7580 m	7130 m	6670 m	6440

(dry rough concrete surface = Coefficient of friction 0.80)

Capacities RX 60-40 Tele/HiLo mast

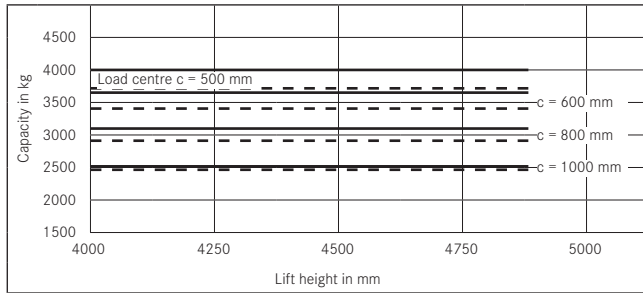

Capacities RX 60-40 with triplex mast

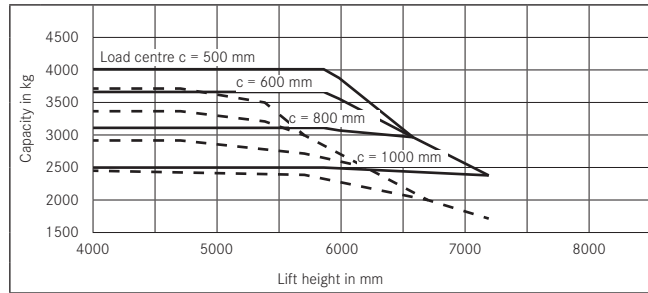

Capacities RX 60-45 Tele/HiLo mast (single tyres)

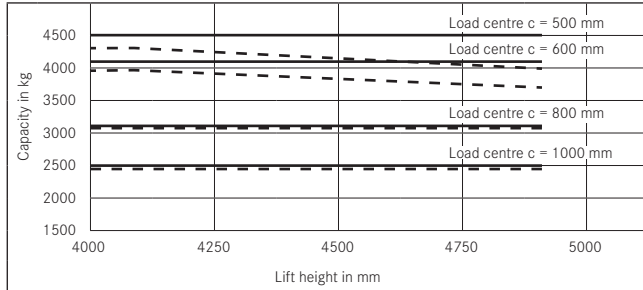

Capacities RX 60-45 Triplex mast/single tyres

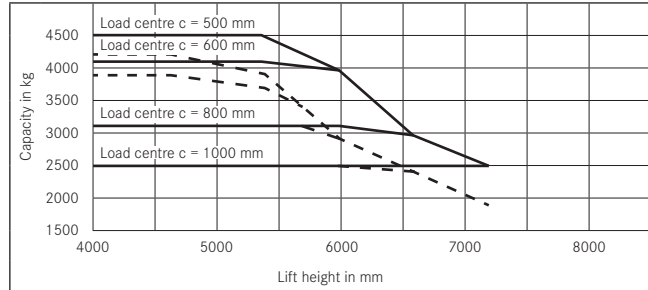

Capacities RX 60-50 Tele/HiLo mast

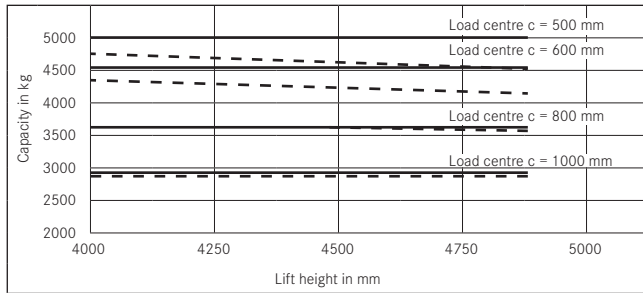

Capacities RX 60-50 Triplex mast/single tyres

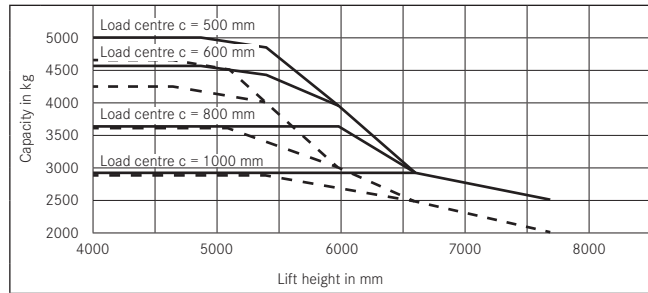

Capacities RX 60-45 Triplex mast/dual tyres

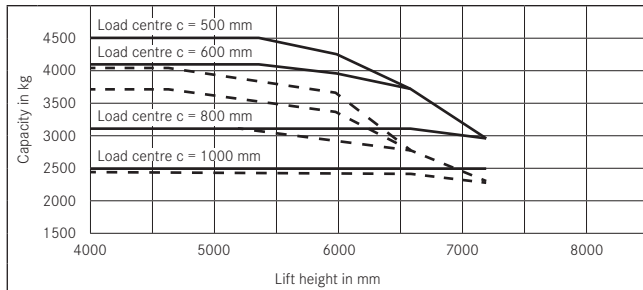

Capacities RX 60-50 Triplex mast/dual tyres

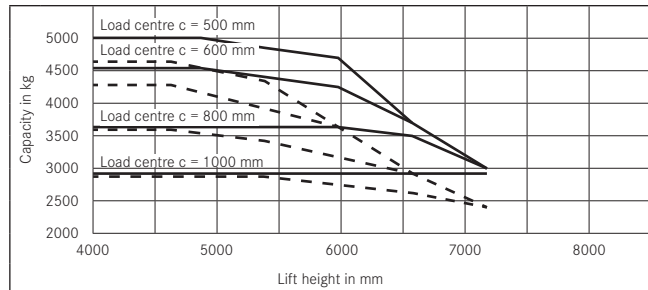

Capacities RX 60-50/600 Triple mast to BH2350

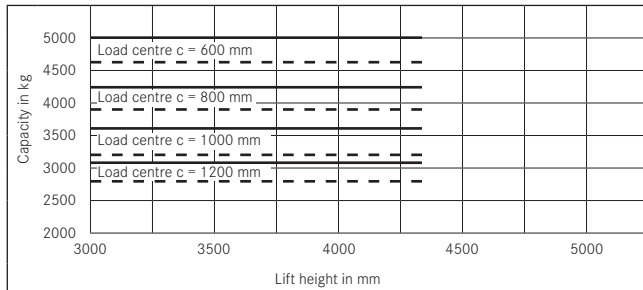

Capacities RX 60-50/600 Triple mast from BH2400

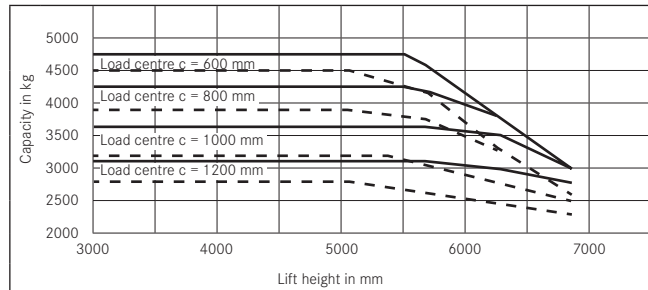

Capacities RX 60-50/600 Tele-mast to BH3250

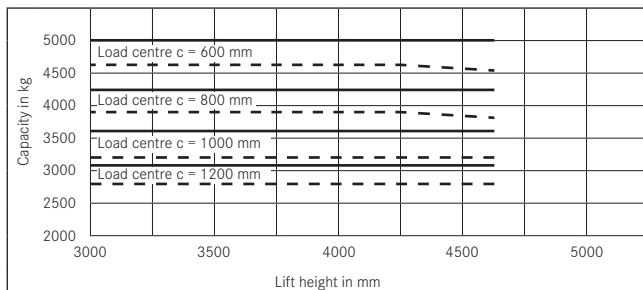

— without Sideshifter  
 - - - with Sideshifter

## Driver's compartment.

The large footwell featuring an inclined floor plate and anti-slip lining provides quick and convenient entry and exit and a relaxed leg position when driving.

The adjustable steering column with its small steering wheel is ergonomically sound, requiring minimal steering movements from the driver. The automotive style pedal layout can be replaced by a dual pedal arrangement if required.

The drive direction switch on the valve lever (lift and lower) allows the driver to change direction without releasing his grip, thus reducing fatigue, even on long shifts.

The fully graphic display is heated to ensure that all essential information (including time, battery charge state, maintenance intervals, etc.) remains clearly visible under all conditions - even in extreme applications such as cold stores, or all-weather indoor/outdoor working.

The entire truck is under constant on-board diagnosis. With 5 selectable drive programs the driver can match the driving characteristics of the RX 60 to the application or his personal preferences. Each program can be precisely matched to the application profile in order to achieve optimum economy and load turnaround.

The driver's compartment of the RX 60 provides generous head room even for tall drivers, with good all-round vision thanks to the large viewing panels in the roof, very slim overhead guard legs and high seating position.

## Blue-Q energy optimisation.

- Activate Blue-Q energy saving mode on the truck at the push of a button.
- Energy saving due to intelligent optimisation of the drive characteristics without impairing the work process.
- Intelligently switches off electrical consumers.
- A saving in energy consumption of up to 20% depending on the application and the truck's equipment.

## Safety.

In conjunction with the mechanical parking and service brake, the RX 60 brakes automatically when the drive pedal is released, guaranteeing safe use at all times. The truck will also hold its position on a gradient without the need to depress the footbrake, further enhancing safety. The RX 60's side battery change can be carried out using a hand pallet truck, low lift pallet truck or forklift truck. This not only gives significant time savings compared to a conventional hoist, but makes the battery changing operation much safer. The risks of operator injury or truck damage are considerably reduced.

## Service.

The maintenance interval of the RX 60 is 1000 operating hours or 12 months. These intervals save time and maintenance costs - especially with single-shift operation, where 1000 hours roughly corresponds to annual operating hours, enabling the maintenance and UVV safety checks to be carried out at the same time. Fast diagnosis via a notebook computer and easily accessible maintenance components, together with readily available parts, guarantee short service times and maximum uptime.

## Drive.

The energy-efficient, noise-optimised three-phase drive unit of the RX 60 acts on the front wheels. High traction power

and driving dynamics, even when climbing ramps or operating on uneven ground, ensure a high turnaround of goods. The 'BOOST' function of the RX 60 is an innovative feature which, when required, calls up maximum torque from the drive motors. Maximum thrust is therefore always available - for example, at kerbs or when pushing pallets.

The maintenance-free, efficiency optimised three-phase drive guarantees a long battery operating life. Thanks to its IP 54 enclosure the entire drive system is protected against the ingress of dirt, dust and moisture, so that even the most inhospitable applications pose no problem.

In addition to all this, electrical regenerative braking means the motors feed back up to 15% of the energy into the battery when the drive pedal is released, increasing the work available from a battery charge by up to 1.5 hours. Interim battery charging, or even changing, is often not necessary. The STILL controller ensures sensitive driving response with optimal utilisation of energy. It also enables the truck to be held on ramps without using the maintenance-free multi-disc brakes, for greater safety and driving comfort. The power electronics are protected within the counterweight and the heat from the controller is dissipated into the counterweight over a large area. This arrangement provides very good cooling without additional fans or filters and makes operating the RX 60 reliable and quiet.

## Electrical system.

The RX 60 features digital control with two independent CAN bus systems which ensure that the drive train is not affected by minor electrical failures elsewhere on the truck, while the drive control unit has dual microprocessor monitoring to ensure safe operation. A pre-prepared wiring harness means that auxiliary electrical equipment can be fitted quickly and easily.

## Mast.

A new generation of optimised visibility masts has been specially developed for this truck. The new concept is based on an outer mast C-section with hoist cylinders positioned behind the mast profiles. Depending on the application, the telescopic or triplex construction offer the following:

- Telescopic: an inexpensive mast design suitable for many applications, with full visibility through the mast.
- Triplex: for use where there are low doorways but high lift heights, to allow utilisation of warehouse space right up to the roof. Here too, there is a clear view through the mast due to the use of two free-lift cylinders.

## Hydraulic system.

The speed of the AC pump drive is demand controlled and is precisely regulated by the dynamic servo assistance through the valve lever or the steering wheel movement. This ensures longer use from a battery charge. Sensitive operation of hydraulics increases working safety thanks to positioning to the nearest millimetre. The hydraulics also improve energy consumption by:

- The high efficiency of the hydraulic pump. A noise reduced internal gear pump specially developed for this truck is used.
- The replacement of the pressure make-up valves with load holding valves. The priority valve for the steering is directly connected to the pump so that hydraulic interfaces and hoses are not required. This guarantees a safer, cleaner operation.



## Your contact

STILL GmbH

Berzeliusstraße 10

D-22113 Hamburg

Telephone: +49 (0)40/73 39-2000

Telefax: +49 (0)40/73 39-2001

info@still.de

**For further information please visit:**

**[www.still.de](http://www.still.de)**

STILL Materials Handling Ltd.

Aston Way, Leyland

Lancashire PR26 7UX

Telephone: +44 (0)1772 644300

Telefax: +44 (0)1772 644303

info@still.co.uk

**For further information please visit:**

**[www.still.co.uk](http://www.still.co.uk)**