



P2870D_{ABG}

Volvo Wheeled Pavers 1.8-4.5 m 55.4 kW



Unrivalled versatility

Go where other pavers cannot with the brand-new P2870D ABG wheeled paver. The most compact paver in the Volvo line-up, this machine is equipped with all the industry leading features of its larger counterparts but designed to deliver unrivalled versatility in small-to-medium paving applications.

All-around talent

Whether accessing narrow jobsites or quickly completing patching work, the P2870D ABG is a talented all-rounder. Featuring power steering, the machine offers a tight (2m) turning radius. Flexible configurations, such as individually operated hopper wings and electro-hydraulic foldable roof, enable you to take on a wider range of paving jobs.



One machine, multiple solutions

The strong P2870D ABG can push a feed truck, while the 9-tonne capacity hopper can also easily be fed by other machinery. Choose between the dual conveyor or the single conveyor, which is unique to Volvo in this size-class and designed to deliver higher output per hour. Proportional conveyor and auger control comes as standard.



Easy to transport

For faster movement around jobsites, the P2870D ABG can travel up to 16km/h. The paver is small enough to be transported alongside a compactor on the same transport vehicle without disassembling the shorter screed extensions and end-gates.



Efficiency at work

Pave for longer without needing to stop for refueling. The efficient Volvo engine and perfectly matched hydraulics deliver the same best-in-class drive system you would expect from the larger Volvo ABG pavers.





MADE FOR THE CITY

Low noise and low emissions make the P2870D ABG the perfect choice when working in inner-city environments. Respecting the local environment is key when working in built-up areas and the low-noise screed contributes to an impressively quiet operation. When it comes to air quality, the efficient 55kW engine delivers low fuel consumption and low CO₂ emissions.



TOTAL OPERATOR CONTROL

The Electronic Paver Management (EPM3) system from Volvo is renowned for its operator friendly controls. The convenient layout intuitively guides operators through individual working functions, with the jog-wheel used to quickly select and adjust functions. With a workstation in common with larger Volvo ABG pavers, this is a machine which operators will instantly feel at home in.

The operator's choice

The P2870D ABG is designed with operators in mind, including many of the state-of-the-art features you would expect to find on larger Volvo ABG pavers. With a fully customizable workstation, easy-to-use controls and superior visibility, you can count on the machine to keep operators comfortable and productive throughout their entire working shift.

Get straight to work

Get to work without delay thanks to Settings Manager, integrated within EPM3, allowing operators to store and retrieve customized settings for individual projects. A fast heating screed, up to 3°C per minute, further supports a fast and hassle-free machine setup.



All weather protection

Operators stay protected whatever the weather, thanks to the all-weather roof which provides built-in sound insulation and sliding extensions which cover the operator even when the seat is extended. An optional glazed area to both sides of the operator platform provides further wind protection.



Tailor-made comfort

For a truly personal level of comfort, operators can customize their working position and switch from sitting to standing within seconds. The control panel is capable of sliding across to both sides of the paver as a complete unit, and tiltable 30-degrees in all directions.



Convenient storage

Safely and securely store the paving panel and screed console within the machine, allowing the operator to leave empty-handed at the end of a working shift. The new storage areas are located under the weather roof and at screed level, and for even further convenience everything is locked/unlocked with the ignition key.



The wheel deal

You can count on the P2870D ABG to deliver all the quality and engineering excellence you expect from Volvo. The machine is packed with a range of intelligent features and technology to help you achieve an outstanding paving performance.

Smooth travel

The P2870D ABG is built on a 6x4 wheel drive undercarriage, for comfort and convenience when travelling between jobs. The machine ride levelers are unique in this class, drawing on technology from the larger Volvo ABG pavers, to offer unrivalled ride comfort.



Rear Frame Lift

Introducing Rear Frame Lift, a new feature unique to Volvo pavers which allows the rear wheels of the paver to be lifted from the ground by pushing down on the screed. Rear Frame Lift is the perfect solution to release the wheels if they are stuck in soft ground, or for faster and easier wheel repairs.



The need for screed

Unlock the full performance of your paver with a Volvo screed, delivering outstanding paving versatility and a smooth, high quality finished surface. Pave with ease thanks to a host of advanced features built on generations of experience from Volvo ABG, helping you to achieve superior paving results.

New VB40 screed

With the new VB40 screed you can pave up to a 4.5m width. The screed features a tiltable walkway, mechanical or hydraulic screed crown and zero-daily maintenance with lifetime lubricated tamper and vibration bearings. Two possible screed extensions are available: 52.5 cm and 27.5 cm, with the latter allowing machine transportation without disassembling extensions and end-gates.



Smarter end-gate control

With hydraulically-controlled end-gates you eliminate the need for manual adjustments. This optional feature keeps operators safely away from traffic and reduces the time required to ensure a clean side finish. The hydraulic end-gates are no thicker than the manual option, with the slim design leaving less uncompacted material within the screed.



Have it your way

The newly designed screed console can be tilted and rotated in any direction, allowing the operator to easily position it according to the requirements of the jobsite and their personal preferences. The new button layout is further optimized for greater convenience and ease of operation.



Paving versatility

COMFORT AND CONVENIENCE

- Fully adjustable operator station
- All-weather roof, optional side glazed areas
- New storage areas
- EPM3: intuitive controls, from bigger pavers

ALL-AROUND TALENT

- Quiet and clean: low noise, low emissions
- Single or dual conveyor configurations
- Individually operated hopper wings
- 2-meter turning radius
- 9-tonne hopper capacity
- 110-liter fuel tank capacity



THE WHEEL DEAL

- 6x4 wheel drive
- Ride levelers **A VOLVO EXCLUSIVE**
- Rear Frame Lift **A VOLVO EXCLUSIVE**
- 16km/h transport speed



HIGH UPTIME, LOWER COSTS

- Easy battery access, with external panel for jump starting
- 3 lubricating points, low daily maintenance
- Maintenance-free bearings for conveyor
- Diesel Particulate Filter with no SCR and no AdBlue
- CareTrack telematics system



THE NEED FOR SCREED

- New VB40 screed: pave up to 4.5 meters
- Slim hydraulically controlled end-gates
- Fully adjustable screed console

Keep on paving

When it comes to successful operations, uptime is key and you can count on the P2870D ABG to keep working harder, for longer. The machine is also designed for quick and easy routine maintenance to keep scheduled downtime to a minimum.

Easy after-treatment

The after-treatment system consists of Diesel Particulate Filter only, meaning there is no SCR and Adblue requirements. This eliminates both the need to replace diesel exhaust fluid and the need for SCR maintenance, helping to keep uptime to a maximum and lower machine running costs.



Easy machine monitoring

With CareTrack you can access a full portfolio of telematics reports, including productivity, health and fuel efficiency, to stay one step ahead of machine condition and performance. Working independently or with the support of your Volvo dealer, you can use data to minimize the risk of unplanned downtime and ensure your machine is performing at its best.





MAINTAINING UPTIME

Complete routine maintenance with speed and ease thanks to a range of features such as drain hoses for fluids, easy battery access with external panel for jump starting and only three lubricating points for the whole machine. The conveyor also has lifetime lubricated, maintenance-free bearings.

Volvo P2870D ABG in detail

Engine		
Manufacturer		Volvo
Model		D3.8H
Fuel		Diesel
Output	kW	55.4
	hp	75.3
at engine speed	r/min	2 200
Coolant		Liquid
Fuel tank capacity	l	110
Exhaust emission		EU Stage V
Paving		
Output (theoretical)*	t/h	330 with single conveyor 230 with double conveyor
Mat thickness (max)	mm	250
Speed		
Paving (max.)	m/min	20
Transport (max.)	km/h	16
Propulsion		
Drive units rear	number	2
Drive units front	number	2
Wheel/Tires		
Rear wheels		
Type		Pneumatic tires
Number	number	2
Dimension		365 / 80 R20
Front steering wheels		
Type		Elastic tires
Number		4
Diameter	mm	457
Width	mm	229
Conveyor		
Hopper capacity	t	9
Number of conveyors		1 or 2
Conveyor speed (max)	m/min	17.9
Auger		
Number of augers		2
Speed (max.)	1/min	72
Diameter	mm	300
Electrical system		
Battery voltage	V	24
Dimensions		
Length with Vario Screed (Walkway up)	mm	4 871
Length (Walkway down)	mm	5 220
Width (tractor only)	mm	1 740
Operating height	mm	3 994
Shipping height	mm	2 899
Weight**		
Tractor unit	kg	7 230
Max. allowable gradeability***		
Tractor unit + screed	%	36
Sound Level		
Driver's ear, according to ISO 11201		
L _{pA}	dB	83
Guaranteed sound power level according to ISO 6395 / Directive 2000/14/EC		
L _{WA}	dB	105
Notes		
*The actual paving output depends upon mat thickness, paving width and paving speed, and will vary according to conditions prevailing on your jobsite. We can assist you in calculating the paving output for a specific project.		
**Approximative weight, without options. Tires filled with water, diesel tank half-full, 75 kg operator, standard hopper and weather roof included.		
***When using extensions, the maximum allowable gradeability will be reduced.		

Specifications

DIMENSIONS

Description	Unit	P2870D ABG
A	Operating length	mm 5 220
B ₁	Operating height	mm 3 995
B ₂	Height weather roof	mm 3 720
B ₃	Shipping height	mm 2 899
C	Tractor width	mm 1 740
D ₁	Height railing	mm 2 523
D ₂	Deck height	mm 1 493
D ₃	Screed height	mm 877
E ₁	Outer hopper width	mm 3 240
E ₂	Inner hopper width	mm 3 103
E ₃	Width oscillating beam	mm 2 559
F ₁	Extension weather roof	mm 580
F ₂	Seat console extension	mm 542
G ₁	Inner loading height	mm 552
G ₂	Outer loading height	mm 701
H ₁	Hopper length to push roller	mm 1 985
H ₂	Hopper length	mm 1 805
J ₁	Distance rear wall auger centre	mm 225
J ₂	Distance auger screed	mm 230
J ₃	Screed depth	mm 850
K ₁	Auger height to ground (center)	mm 350-90
K ₂	Diameter auger	mm 300
L	Ground clearance	mm 145
M	Diameter wheel	mm 459
N	Diameter push roller	mm 110
O	Conveyor width	mm 710
S ₁	Basic screed width	m 1.8
S ₂	Extended screed width	m 3.5
T ₁	Front wheel/track to push roller	mm 960
T ₂	Distance front wheels	mm 600
T ₃	Track length/wheel base	mm 1 833
T ₄	Track/wheel distance to rear wall	mm 589
U ₁	Wheel/track gauge wheels/ tracks centre to centre	mm 1 410
U ₂	Track pad width/wheel width	mm 160
W ₁	Width of walkway	mm 300
W ₂	Height of walkway	mm 295

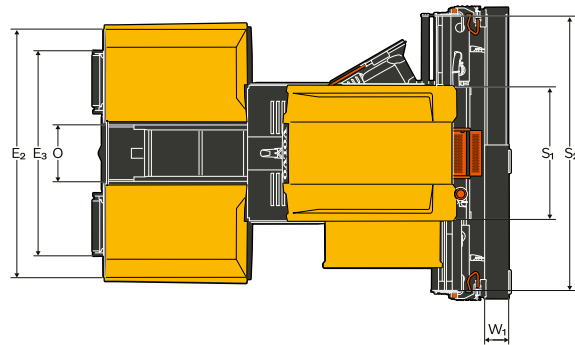
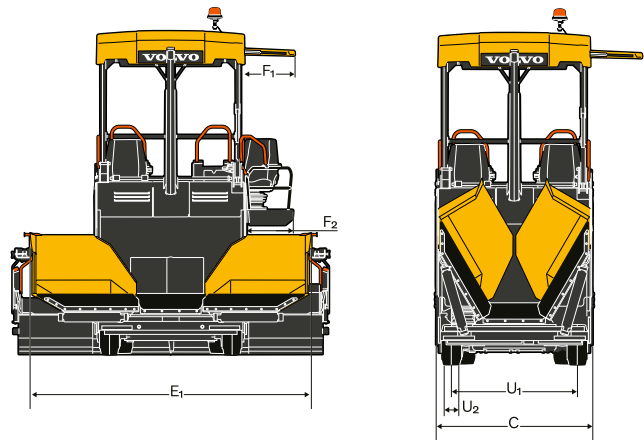
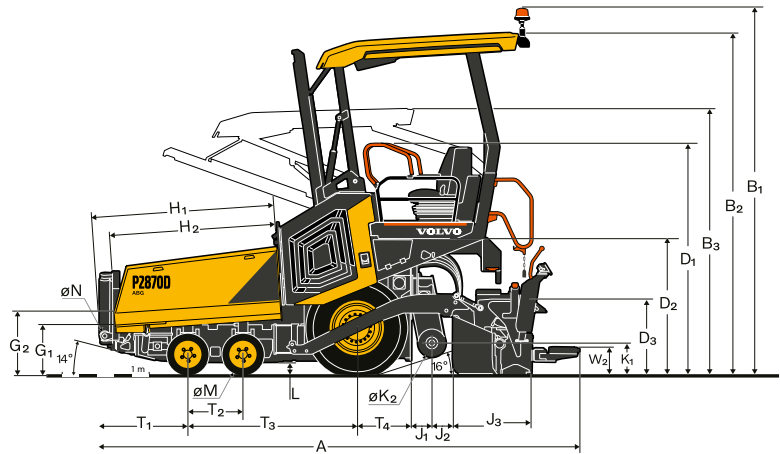

OPERATING WEIGHT¹ OF SCREED IN KG

At working width	3.5 m	4.0 m	4.5 m
VB 40 ETC min Mechanical crown control and standard end-gates	1 638	1 977	2 186
VB 40 ETC max Hydraulic crown and hydraulic end-gates	1 720	2 058	2 267

¹ Including auger extensions, channel plates, end-gates.

Equipment

STANDARD EQUIPMENT

Engine

Volvo diesel engine EU Stage V

Drive

Electronic drive control

Independent rear wheel drives

Driven front axle

Hydraulic ride levelers

Load dependent efficient drive system

Active steering

Rear wheels without ballast

Material Management

Proportional ultrasonic auger control

Proportional conveyor control

Reversible direction of auger rotation

Single conveyor

Mechanical auger height adjustment

Oscillating cross beam with two mounting positions

110 mm push roller

Electronics

Electronic Paver Management (EPM 3)

Settings Manager

Service interval manager

Adjustable and slideable control station

Two adjustable and revolving screed control panels

Battery master switch

Electric switching cabinet

Back-up alarm

Tool kit

MATRIS support

Structure

Manual folding all-weather roof Glass-fibre Reinforced Plastic (GRP)

Two swing out seats

Storage compartment under weather roof

Near field mirrors at weather roof

Volvo Green Key

Screed

VB 40 ETC 1.80 - 3.50 m

Mechanical crown adjustment

Screed lock

Split towing arms

Lights

Work lights

Operator's platform lighting

Home light function

Environmental

Sound insulation für engine compartment and operator station

OPTIONAL EQUIPMENT

Material Management

Two independent conveyors

Reversible conveyor

Individual operating hopper wings

Mechanically operated front apron

Hydraulically operated front apron

Push-roller D110 plus 100 mm more space

Electronics

Lateral emergency stop

Additional socket 230V 50Hz

Traction isolator switch

CareTrack GSM / Satellite

Levelling equipment

Case for control panels

Structure

Deluxe seats with heating and USB charger

Electrohydraulic powered weather roof

Seat side windshield

Ballast weight

Screed

Rear Frame Lift

Screed anti-climbing lock

Screed Assist

Hydraulic end-gates (VB 40)

Hydraulic heated end-gates (VB 40)

Hydraulic crown adjustment

Paving width reduction

Edging shoes 3/5/7/12 cm

Lights

Worklights LED

Two additional rear lights LED

Additional auger light LED

Additional lights levelling scale LED

Portable worklight LED with magnetic base

Warning beacon LED

Road travel lighting right-hand traffic

Road travel lighting left-hand traffic

Environmental

Extractor for bituminous fumes

Integrated emulsion spraying system

High performance spray cleaning unit

Biodegradable hydraulic oil and Bypass filter

SELECTION OF VOLVO OPTIONAL EQUIPMENT

Electro-hydraulically foldable roof



Choice of single or dual conveyor



Hydraulic crown control



Storage area at screed level



Lateral emergency switch



LED light packages



Not all products are available in all markets. Under our policy of continuous improvement, we reserve the right to change specifications and design without prior notice. The illustrations do not necessarily show the standard version of the machine.

VOLVO

Volvo Construction Equipment

volvoce.com