

KOMATSU®

PC160LC-8

NET HORSEPOWER

86 kW **115 HP** @ 2200 rpm

OPERATING WEIGHT

16680–17120 kg **36,770–37,740 lb**

BUCKET CAPACITY

0.37–0.95 m³ **0.48–1.24 yd³**

PC
160
LC



HYDRAULIC EXCAVATOR

Photo may include optional equipment.

WALK-AROUND

Ecology and Economy Features

- **Low Emission Engine**

A powerful turbocharged and air-to-air aftercooled Komatsu SAA4D107E-1 engine provides 86 kW **115 HP** (net). This engine is EPA Tier 3 and EU Stage 3A emissions certified, without sacrificing power or machine productivity.

- **Low Operational Noise**

The dynamic noise is reduced providing low noise operation

- **Selectable Working Modes**

Match performance to the application and minimize fuel consumption with E mode

- **Extended Idling Caution**

- **Eco-gauge**

Assists energy saving operation

- **Low Fuel Consumption**

Additional Features

- Innovative cab design
- Slip-resistant plates to improve foot grip
- Large side-view and sidewise mirrors
- Rear view monitoring system
- Operator Protective Guard (OPG) top guard Level 2 capable



Large TFT LCD Monitor

- Easy-to-see and use large 7" multi-function color monitor
- Can be displayed in 12 languages

TFT : Thin Film Transistor
LCD : Liquid Crystal Display

- Easy hydraulic flow adjustment



KOMTRAX equipped machines can send location, SMR and operation maps to a secure website utilizing wireless technology. Machines also relay error codes, cautions, maintenance items, fuel levels, and much more.

Maintenance Features

- Long replacement interval of engine oil, engine oil filter, hydraulic oil and hydraulic filter
- Fuel pre-filter with water separator as standard equipment
- Side-by-side cooling concept enables servicing of individual cooling modules
- Easy access to engine oil filter, fuel filter and fuel drain valve
- Fuel filter is remotely mounted to improve accessibility
- Self-diagnostic monitor

Large Comfortable Cab

- Low-noise cab design
- Low vibration with viscous cab damper mounting
- Highly pressurized cab with automatic air conditioner
- Operator seat and console with armrest that enables ergonomic operational posture
- Automatic air conditioner

NET HORSEPOWER

86 kW 115 HP @ 2200 rpm

OPERATING WEIGHT

16680 – 17120 kg

36,770 – 37,740 lb**BUCKET CAPACITY**0.37 – 0.95 m³**0.48 – 1.24 yd³*****Reliability Features***

- High rigidity work equipment
- Sturdy frame structure
- Reliable Komatsu manufactured major components
- Reliable electronic devices
- In-line hydraulic filters



Photo may include optional equipment.

ECOLOGY & ECONOMY FEATURES

Komatsu Technology



Komatsu develops and produces all major components in-house such as engines, electronics and hydraulic components. Combining “Komatsu Technology” and customer feedback, Komatsu is achieving great advancements in technology. To achieve both high levels of productivity and economical performance, Komatsu has developed the main components with a total control system. The result is a new generation of high performance and environment-friendly excavators.

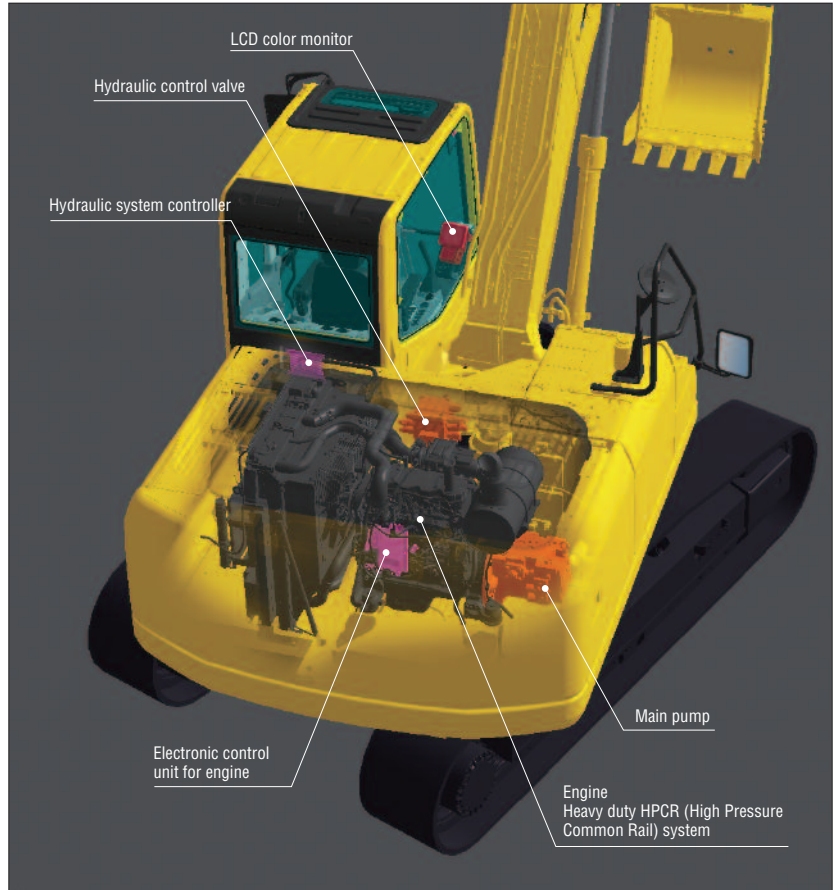

Low Emission Engine

The Komatsu SAA4D107E-1 engine is EPA Tier 3 and EU Stage 3A emission regulations certified, without sacrificing power or machine productivity.



Low Operational Noise

A low-noise engine, muffler, and sound absorbing materials reduce engine noise at the source.

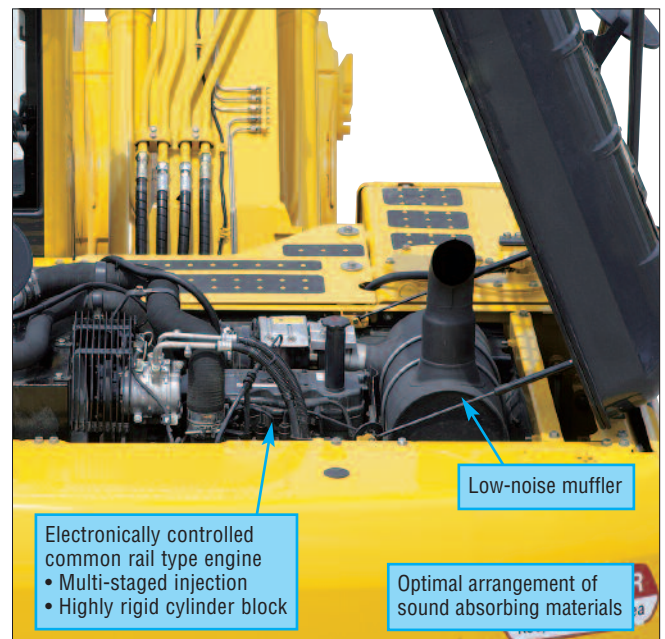

Working Mode Selection

The PC160LC-8 excavator is equipped with five working modes (P, E, L, B, and ATT). Each mode is designed to match engine speed, pump flow, and system pressure with the current application. This provides the flexibility to match equipment performance to the job at hand.

Working Mode	Application	Advantage
P	Power mode	<ul style="list-style-type: none"> Maximum production/power Fast cycle times
E	Economy mode	<ul style="list-style-type: none"> Excellent fuel economy
L	Lifting mode	<ul style="list-style-type: none"> Hydraulic pressure is increased by 7%
B	Breaker mode	<ul style="list-style-type: none"> Optimum engine rpm, hydraulic flow, 1-way
ATT	Attachment mode	<ul style="list-style-type: none"> Optimum engine rpm, hydraulic flow, 2-way

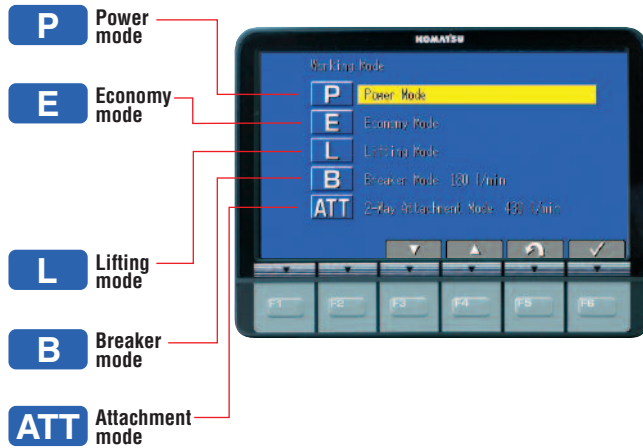

Economy Mode

Economy mode is environmentally friendly. Fuel consumption is reduced 10% (compared with PC160LC-8 Power mode).

Lifting Mode

When the lifting mode is selected, lifting capacity is increased 7% by raising hydraulic pressure.

Breaker Mode

Flow can be adjusted from the cab to match various one-way flow attachment requirements.

Attachment Mode

Flow can be adjusted from the cab to match various two-way flow attachment requirements.

Idling Caution

To help prevent unnecessary fuel consumption, an idling caution is displayed on the monitor if the engine idles for 5 minutes or more.



Eco-gauge that Assists Energy-saving Operation

The Eco-gauge, that can be recognized at a glance on the right of the multi-monitor, allows the operator to maintain work in the green zone and reduce fuel consumption, for environment-friendly energy-saving operation.



Operating conditions that keep the Eco-gauge in the green bars indicate that fuel consumption can be potentially reduced by operating in E mode.

Low Fuel Consumption

The Komatsu SAA4D107E-1 [ecot3] engine enables NOx emissions to be significantly reduced with the accurate multi-staged fuel injection by the engine controller. It improves total engine durability using the high-pressure fuel injection system developed specifically for construction machinery. This excavator significantly reduces hourly fuel consumption using highly-efficient matching techniques of the engine and hydraulic unit and also provides features that promote energy-saving operation such as the E mode and Eco-gauge.

RELIABILITY FEATURES

High Rigidity Work Equipment

Boom and arms are constructed with thick plates of high tensile strength steel. In addition, these structures are designed with large cross-sectional areas and generous use of castings. The result is working attachments that exhibit long term durability and high resistance to bending and torsional stress.

Sturdy Frame Structure

The revolving frame, center frame, and undercarriage are designed using the most advanced three-dimensional CAD and FEM analysis technology.

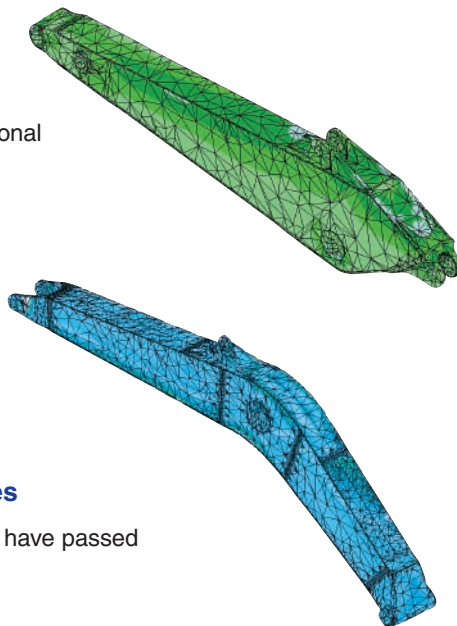

Reliable Components

All of the major machine components such as engine, hydraulic pumps, hydraulic motors, and control valves are exclusively designed and manufactured by Komatsu.

Highly Reliable Electronic Devices

Exclusively designed electronic devices have passed severe testing.

- Controllers
- Sensors
- Connectors
- Wiring

Metal Guard Rings Protect All the Hydraulic Cylinders and Improve Reliability

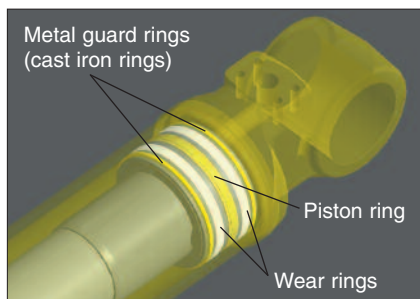

DT-type Connectors

DT-type connectors seal tightly and have high reliability.

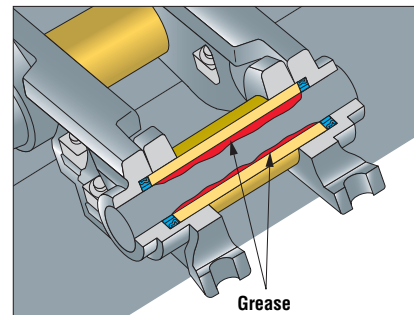
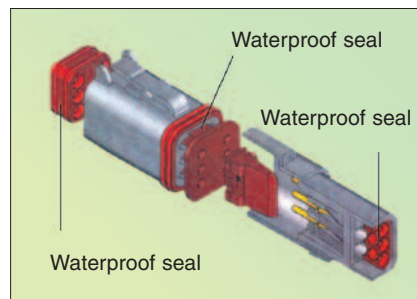

Grease Sealed Track

The PC160LC-8 uses grease sealed tracks for extended undercarriage life.



High-Pressure In-line Filters

The PC160LC-8 has high pressure in-line filters installed at the pump discharge ports. This provides an additional level of hydraulic system protection.

O-ring Face Seals

Hydraulic hoses are equipped with O-ring seals versus conventional taper seals to provide extended leak-free life.

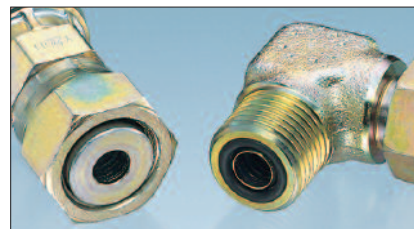

WORKING ENVIRONMENT



Low Noise Cab

The newly-designed cab is highly rigid and has excellent sound absorption ability. Improvement of noise source reduction and use of low noise engine, hydraulic equipment, and air conditioner allow this machine to generate a low level of noise similar to that of a modern automobile.

Low Vibration with Cab Damper Mounting

The PC160LC-8 uses viscous damper mounting for the cab that incorporates a longer stroke and the addition of a spring. The new cab damper mounting combined with high rigidity deck aids vibration reduction at the operator seat.

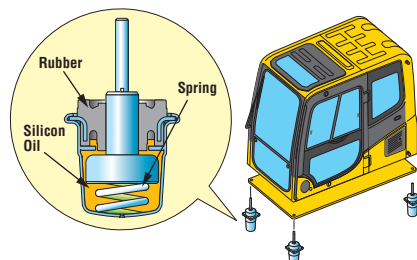

Wide Newly-designed Cab

Newly-designed wide spacious cab includes a seat with reclining backrest. The seat height and longitudinal inclination are easily adjusted using a pull-up lever. You can set the appropriate operational posture of the armrest together with the console. Reclining the seat further enables you to place it into the fully flat state with the headrest attached.



Pressurized Cab

Automatic air conditioner, air filter, and a higher internal air pressure help prevent dust from entering the cab.

Automatic Air Conditioner

Enables you to easily and precisely set cab temperature with the instruments on the large LCD screen. The bi-level control function keeps the inside of the cab comfortable from top to bottom throughout the year. Defroster function keeps cab glass clear.



Lock Lever

When the lock lever is placed in the lock position all hydraulic controls (travel, swing, boom, arm and bucket) are inoperable.



Lever shown in lock position

PC160LC-8 HYDRAULIC EXCAVATOR

New Cab Design for Hydraulic Excavators

The cab is designed specifically for hydraulic excavators and gains strength from the reinforced pipe-structured framework. The cab framework provides high durability and impact resistance with very high impact absorbency.

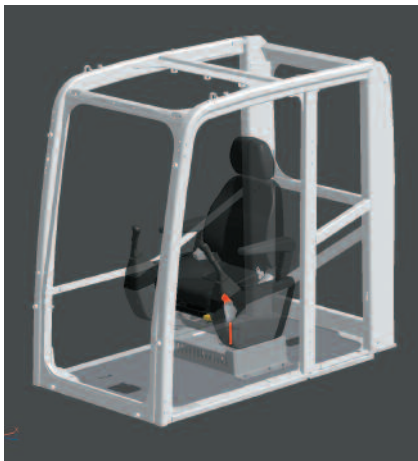

OPG Level 2 Top Guard (optional)

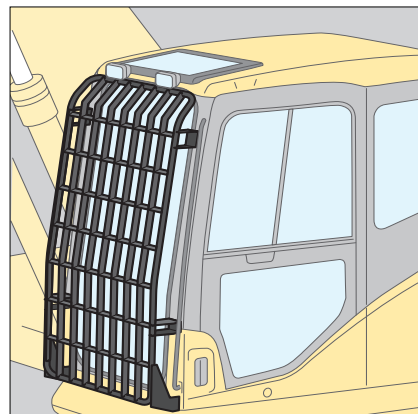

Front Full Guard Level 2 (optional)

Slip-Resistant Plates

Durable slip resistant plates help maintain foot traction.



Large Side-view and Sidewise Mirrors



Thermal and Fan Guards

Guards are placed around the fan drive and high-temperature parts of the engine.



Skylight

Skylight can be opened to improve overhead visibility.



Large Serrated Steps



Large Handrail



Travel Alarm

An alarm is installed as standard equipment to give other workers a warning when the machine travels in forward or reverse.

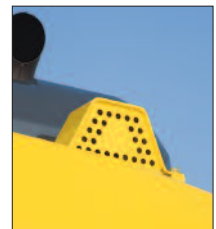

MAINTENANCE FEATURES

Easy Maintenance

Side-by-side Cooling

Since the radiator, aftercooler and oil cooler are arranged side-by-side, it is easy to clean, remove and install them. The radiator, aftercooler, and oil cooler are made of aluminum, have high cooling efficiency and are easily recycled.



Equipped with Fuel Pre-filter with Water Separator

Removes water and contaminants in the fuel to help prevent fuel problems (with built in priming pump).



Maintenance Cost Reduction

Long Replacement Interval of Hydraulic and Engine Oil and Filters



Hydraulic oil filter

High-performance filtering materials and long-life oil extend the oil and filter replacement intervals.

Engine oil & Engine oil filter every **500** hours

Hydraulic oil every **5000** hours

Hydraulic oil filter every **1000** hours

Easy Access to Engine Oil Filter, Engine Main Fuel Filter and Fuel Drain Valve

Engine oil filter, engine main fuel filter and fuel drain valve are remote mounted to improve accessibility.



Engine Oil Filter

Fuel Filter

Fuel Drain Valve

Equipped with Eco-drain Valve as Standard

Enables easier and cleaner engine oil changes

Washable Cab Floor Mat

The PC160LC-8's cab floor is easy to keep clean. The gently inclined surface has a flanged floor mat and drainage holes to facilitate runoff.

Sloping Track Frame

Helps prevent dirt and sand from accumulating and allows easy mud removal.

Gas Assisted Engine Hood Damper Cylinders

The engine hood can be easily opened and closed with the help of the gas assisted engine hood damper cylinders.



Air Conditioner Filters

Both the fresh air filter and the recirculation air filter are removed and installed without the use of tools, facilitating easy filter maintenance.



Recirculation air filter



Fresh air filter

Long Work Equipment Greasing Interval

High quality BMRC bushings and resin shims are installed in the work equipment, excluding the bucket, which can extend the greasing interval to 500 hours.

Self-Diagnostic Monitor

The PC160LC-8 features the most advanced diagnostics system in the industry. The Komatsu-exclusive system identifies maintenance items, reduces diagnostic times, indicates oil and filter replacement hours, and displays error codes.

Continuous Machine Monitoring System

When the starting switch is turned ON, check-before-starting items and caution items appear on the LCD. If abnormalities are found, a warning lamp blinks and a warning buzzer sounds. The continuous machine condition checks help prevent the development of serious problems and allow the operator to concentrate on the work at hand.

Abnormalities Display with Code

When an abnormality occurs during operation, a user code is displayed. When an important user code is displayed, a caution lamp blinks and a warning buzzer sounds to alert the operator to take action.

Oil Maintenance Function

When the machine exceeds the oil or filter replacement time, the oil maintenance monitor will display lights to inform the operator.

Trouble Data Memory Function

The monitor stores a record of abnormalities for effective troubleshooting.



Normal display

Maintenance List	Interval	Remain
Engine Oil Change	500 h	490 h
Eng Oil Filter Change	500 h	490 h
Fuel Main Filter Change	1000 h	980 h
Fuel Pre Filter Change	500 h	490 h
Hyd Oil Filter Change	1000 h	980 h
H/Tank Breather Change	900 h	490 h

Maintenance time display

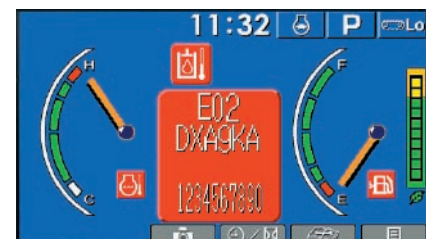

Error code display



Photo may include optional equipment.

Large LCD Color Monitor

Large Multi-Lingual LCD Monitor

A large user-friendly color monitor enables accurate and smooth work. Improved screen visibility is achieved by use of a TFT liquid crystal display that can easily be read at various angles and lighting conditions. All switches are simple and easy to operate. Industry-first function keys facilitate multi-function operations. Displays data in 12 languages to globally support operators around the world.



Indicators

- | | |
|----------------------------------|-----------------------------------|
| 1 Auto-decelerator | 5 Hydraulic oil temperature gauge |
| 2 Working mode | 6 Fuel gauge |
| 3 Travel speed | 7 Eco-gauge |
| 4 Engine water temperature gauge | 8 Function switches menu |

Basic operation switches

- | | |
|-------------------------|---------------------|
| 1 Auto-decelerator | 4 Buzzer cancel |
| 2 Working mode selector | 5 Wiper |
| 3 Travel speed selector | 6 Windshield washer |

Rear-view Monitoring System

On the large LCD color monitor, the operator can access and view one standard video camera that will display areas directly behind the machine.

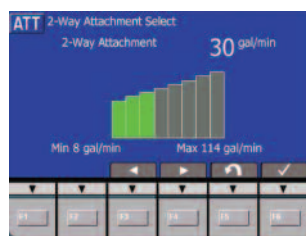

Improved attachment flow control

Flow rates can easily be adjusted for one-way and two-way flow attachments through the monitor.

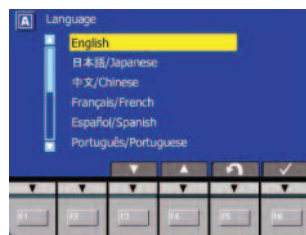

Multiple languages

The monitor can be displayed in 12 languages

PC160LC-8 HYDRAULIC EXCAVATOR

SPECIFICATIONS



ENGINE

Model Komatsu SAA4D107E-1*
 Type Water cooled, 4-cycle, direct injection
 Aspiration Turbocharged, and air-to-air aftercooled
 Number of cylinders 4
 Bore 107 mm **4.21"**
 Stroke 124 mm **4.88"**
 Piston displacement 4.46 ltr **272 in³**
 Horsepower:
 Gross (SAE J1995) 90 kW **121 HP** @ 2200 rpm
 Net (ISO 9249/SAE J1349) 86 kW **115 HP** @ 2200 rpm
 Governor All speed control, electronic
 Lubrication system :
 Method Gear pump, force-lubrication
 Filter Full-flow
 Air cleaner Dry type with double elements
 and auto dust evacuator, plus dust indicator

*EPA Tier 3 and EU Stage 3A emissions certified.



HYDRAULIC SYSTEM

Type HydrauMind (Hydraulic Mechanical Intelligence New Design) system, Closed-center system with load-sensing valves and pressure-compensated valves
 Number of selectable working modes 5
 Main pump:
 Type Variable displacement piston type
 Pumps for Boom, arm, bucket, swing, and travel circuits
 Maximum flow 312 ltr/min **82.4 U.S. gal/min**
 Supply for control circuit Self-reducing valve
 Hydraulic motors:
 Travel 2 x axial piston motor with parking brake
 Swing 1 x axial piston motor with swing holding brake
 Relief valve setting:
 Implement circuits 37.3 MPa 380 kgf/cm² **5,400 psi**
 Travel circuit 37.3 MPa 380 kgf/cm² **5,400 psi**
 Swing circuit 28.9 MPa 295 kgf/cm² **4,195 psi**
 Pilot circuit 3.2 MPa 33 kgf/cm² **470 psi**
 Hydraulic cylinders:
 (Number of cylinders – bore x stroke x rod diameter)
 Boom 2–110 mm x 1175 mm x 75 mm **4.3" x 46.3" x 3.0"**
 Arm 1–120 mm x 1342 mm x 85 mm **4.7" x 52.8" x 3.3"**
 Bucket 1–105 mm x 1027 mm x 70 mm **4.1" x 40.4" x 2.8"**



SWING SYSTEM

Drive method Hydrostatic
 Swing reduction Planetary gear
 Swing circle lubrication Grease-bathed
 Service brake Hydraulic lock
 Holding brake/Swing lock Mechanical disc brake
 Swing speed 12.0 rpm
 Swing torque 4331 kg•m **31,314 ft. lbs.**



DRIVES AND BRAKES

Steering control Two levers with pedals
 Drive method Hydrostatic
 Maximum drawbar pull 156 kN 15950 kgf **35,160 lbf**
 Gradeability 70%, 35°
 Maximum travel speed: High 5.5 km/h **3.4 mph**
 Low 3.4 km/h **2.1 mph**
 Service brake Hydraulic lock
 Parking brake Mechanical disc



UNDERCARRIAGE

Center frame X-leg
 Track frame Box-section
 Track type Sealed
 Track adjuster Hydraulic
 Number of shoes (each side) 44
 Number of carrier rollers (each side) 2
 Number of track rollers (each side) 7



SERVICE REFILL CAPACITIES

Fuel tank 280 ltr **74 U.S. gal**
 Radiator 18.5 ltr **4.9 U.S. gal**
 Engine 16.0 ltr **4.2 U.S. gal**
 Final drive (each side) 3.3 ltr **0.9 U.S. gal**
 Swing drive 4.5 ltr **1.2 U.S. gal**
 Hydraulic tank 121 ltr **32.0 U.S. gal**



OPERATING WEIGHT (APPROXIMATE)

Operating weight including 5150 mm **16'11"** one-piece boom, 2610 mm **8'7"** arm, SAE heaped 0.65 m³ **0.85 yd³** backhoe bucket, rated capacity of lubricants, coolant, full fuel tank, operator, and standard equipment.

Shoes		Operating Weight		Ground Pressure		
mm	in	kg	lb	kPa	kg/cm ²	psi
600	24"	16900	37,260	40.3	0.41	5.84
700	28"	17120	37,740	35.0	0.36	5.08
800	31.5"	17420	38,400	31.0	0.32	4.49



DIMENSIONS

	Arm Length	2610 mm 8'7"	2900 mm 9'6"
A	Overall length	8565 mm 28'1"	8565 mm 28'1"
B	Length on ground (transport)	4760 mm 15'7"	4565 mm 15'0"
C	Overall height (to top of boom)*	3025 mm 9'11"	3125 mm 10'3"

D	Overall width**	2590 mm 8'6"
E	Overall height (to top of cab)*	3030 mm 9'10"
F	Ground clearance, counterweight	1055 mm 3'6"
G	Ground clearance (minimum)	440 mm 1'5"
H	Tail swing radius	2435 mm 8'0"
I	Track length on ground	3170 mm 10'5"
J	Track length	3965 mm 13'0"
K	Track gauge	1990 mm 6'6"
L	Width of crawler	2590 mm 8'6"
M	Shoe width	600 mm 24"
N	Grouser height	26 mm 1.0"
O	Machine cab height	2065 mm 6'9"
P	Machine cab width	2490 mm 8'2"
Q	Distance, swing center to rear end	2390 mm 7'10"

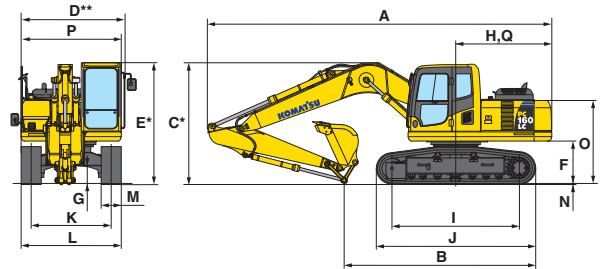

* Including grouser height ** Including handrail



BACKHOE BUCKET AND ARM COMBINATION

Bucket Type	Bucket				Arms	
	Capacity		Width	Weight	2.6 m 8'7"	2.9 m 9'6"
Komatsu TL	0.47 m ³	0.61 yd ³	610 mm 24"	506 kg 1,116 lb	V	V
	0.62 m ³	0.81 yd ³	762 mm 30"	568 kg 1,252 lb	V	V
	0.78 m ³	1.02 yd ³	914 mm 36"	660 kg 1,454 lb	W	X
	0.95 m ³	1.24 yd ³	1067 mm 42"	705 kg 1,554 lb	X	Y
Komatsu HP	0.37 m ³	0.48 yd ³	508 mm 20"	511 kg 1,126 lb	V	V
	0.47 m ³	0.61 yd ³	610 mm 24"	572 kg 1,260 lb	V	V
	0.62 m ³	0.81 yd ³	762 mm 30"	649 kg 1,431 lb	V	V
	0.78 m ³	1.02 yd ³	914 mm 36"	735 kg 1,620 lb	W	X
Komatsu HPS	0.95 m ³	1.24 yd ³	1067 mm 42"	806 kg 1,776 lb	Y	Y
	0.37 m ³	0.48 yd ³	508 mm 20"	563 kg 1,241 lb	V	V
	0.47 m ³	0.61 yd ³	610 mm 24"	635 kg 1,400 lb	V	V
	0.62 m ³	0.81 yd ³	762 mm 30"	729 kg 1,607 lb	V	W
Komatsu HPS	0.78 m ³	1.02 yd ³	914 mm 36"	831 kg 1,833 lb	X	X
	0.95 m ³	1.24 yd ³	1067 mm 42"	919 kg 2,027 lb	Y	Z

V – Used with densities up to 3,500 lb/yd³, W – Used with densities up to 3,000 lb/yd³
 X – Used with densities up to 2,500 lb/yd³, Y – Used with densities up to 2,000 lb/yd³, Z – Not useable

COMMENTS: When using any quick coupler or other attachment equipment, there is an increased risk of the bucket hitting the cab.

*See the Operation & Maintenance Manual for detailed bucket installation instructions.

WORKING RANGES

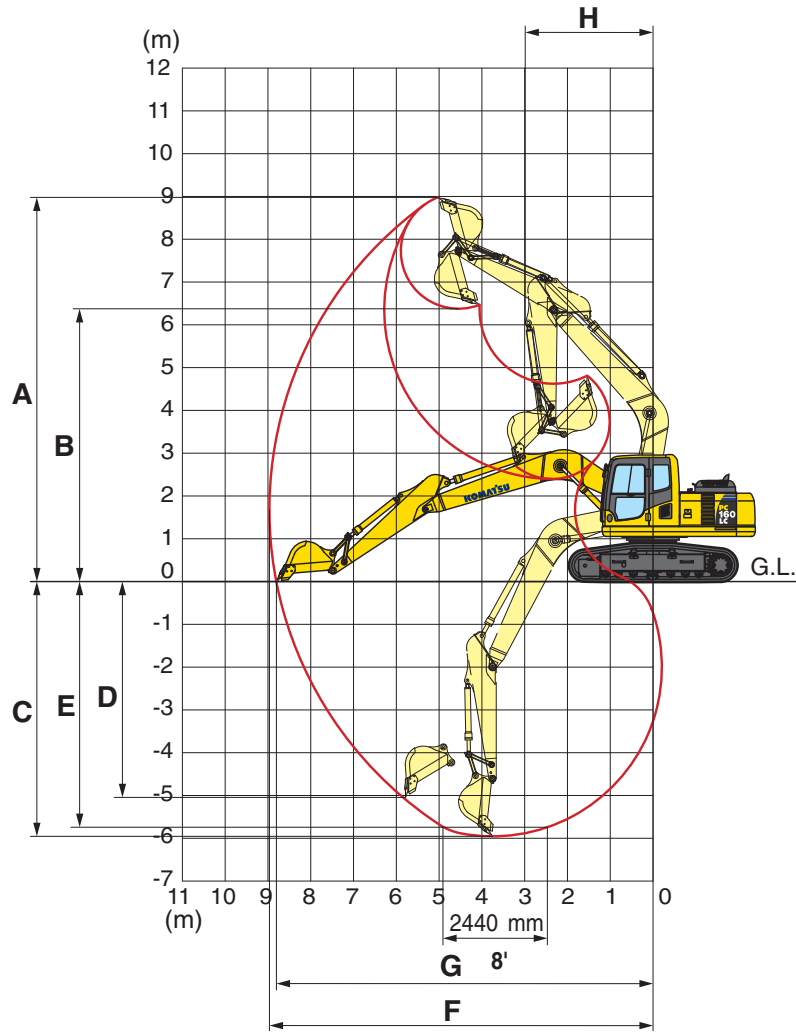

	Arm	2610 mm 8'7"	2900 mm 9'6"
A	Max. digging height	8980 mm 29'6"	9130 mm 29'11"
B	Max. dumping height	6370 mm 20'11"	6525 mm 21'5"
C	Max. digging depth	5960 mm 19'6"	6250 mm 20'6"
D	Max. vertical wall digging depth	5040 mm 16'6"	5320 mm 17'5"
E	Max. digging depth of cut for 8' level bottom	5740 mm 18'10"	6050 mm 19'10"
F	Max. digging reach	8960 mm 29'5"	9235 mm 30'4"
G	Max. digging reach at ground level	8800 mm 28'10"	9075 mm 29'9"
H	Min. swing radius	2990 mm 9'10"	2995 mm 9'10"
SAE rating	Bucket digging force at power max.	109 kN 11100 kgf/24,470 lb	109 kN 11100 kgf/24,470 lb
	Arm crowd force at power max.	83.4 kN 8500 kgf/18,740 lb	77.5 kN 7900 kgf/17,420 lb
ISO rating	Bucket digging force at power max.	123 kN 12500 kgf/27,560 lb	123 kN 12500 kgf/27,560 lb
	Arm crowd force at power max.	86.3 kN 8800 kgf/19,400 lb	79.4 kN 8100 kgf/17,860 lb

LIFTING CAPACITIES



LIFTING CAPACITY

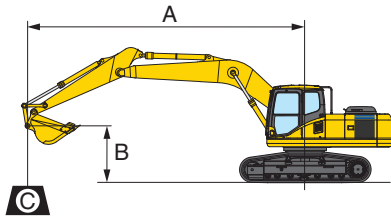

- A: Reach from swing center
- B: Bucket hook height
- C: Lifting capacity
- Cf: Rating over front
- Cs: Rating over side
- ☉: Rating at maximum reach

Conditions:

- Arm: 2610 mm 8'7"
- Boom length 5150 mm 16'11"
- Bucket 0.65 m³ 0.85 yd³ (SAE heaped)
- Bucket weight: 500 kg 1,100 lb.
- Lifting mode: On

PC160LC-8		Shoe 600 mm 24"										Unit: kg/lb	
B \ A	1.5 m 5'		3.0 m 10'		4.6 m 15'		6.1 m 20'		7.6 m 25'		☉ MAX		
	Cf	Cs	Cf	Cs	Cf	Cs	Cf	Cs	Cf	Cs	Cf	Cs	
7.6 m 25'											*2250 *5,000	*2250 *5,000	
6.1 m 20'							*3050 *6,800	2850 6,300			*2000 *4,400	*2000 *4,400	
4.6 m 15'							4150 *9,100	2850 6,200			*2000 *4,400	1950 4,300	
3.0 m 10'			*8450 *18,600	8350 18,400	*5750 *12,700	4350 9,600	4450 9,800	2700 6,000	*2750 *6,100	1800 3,900	*2050 *4,600	1700 3,800	
1.5 m 5'			*8500 *18,800	7300 16,100	6850 15,100	3950 8,800	4250 9,400	2550 5,600	2950 6,500	1700 3,800	*2250 *5,000	1600 3,500	
0 m 0'			*7650 *16,900	6900 15,200	6550 14,400	3700 8,200	4100 9,100	2400 5,300	2900 6,400	1650 3,700	*2650 *5,900	1650 3,600	
-1.5 m -5'	*5900 *13,000	*5900 *13,000	*10500 *23,200	6850 15,100	6400 14,100	3600 8,000	4050 8,900	2350 5,200			3150 6,900	1800 4,000	
-3.0 m -10'	*9400 *20,700	*9400 *20,700	*10900 *24,100	6950 15,400	6450 14,200	3650 8,000	4100 9,000	2350 5,200			3900 8,600	2250 5,000	
-4.6 m -15'			*7900 *17,400	7250 16,000	*5250 *11,500	3800 8,400					*4950 *10,900	3650 8,000	

PC160LC-8		Shoe 700 mm 28"										Unit: kg/lb	
B \ A	1.5 m 5'		3.0 m 10'		4.6 m 15'		6.1 m 20'		7.6 m 25'		☉ MAX		
	Cf	Cs	Cf	Cs	Cf	Cs	Cf	Cs	Cf	Cs	Cf	Cs	
7.6 m 25'											*2250 *5,000	*2250 *5,000	
6.1 m 20'							*3050 *6,800	2900 6,400			*2000 *4,400	*2000 *4,400	
4.6 m 15'							*4150 *9,100	2850 6,300			*2000 *4,400	*2000 *4,400	
3.0 m 10'			*8450 *18,600	*8450 *18,600	*5750 *12,700	4400 9,700	4500 9,900	2750 6,000	*2750 *6,100	1800 4,000	*2050 *4,600	1750 3,800	
1.5 m 5'			*8500 *18,800	7400 16,300	6900 15,300	4050 8,900	4350 9,500	2600 5,700	3000 6,600	1750 3,900	*2250 *5,000	1650 3,600	
0 m 0'			*7650 *16,900	7000 15,400	6650 14,600	3800 8,300	4200 9,200	2450 5,400	2950 6,500	1700 3,700	*2650 *5,900	1650 3,700	
-1.5 m -5'	*5900 *13,000	*5900 *13,000	*10500 *23,200	6950 15,300	6500 14,300	3650 8,100	4100 9,100	2400 5,300			3200 7,000	1850 4,100	
-3.0 m -10'	*9400 *20,700	*9400 *20,700	*10900 *24,100	7050 15,600	6550 14,400	3700 8,200	4150 9,100	2400 5,300			3950 8,700	2300 5,100	
-4.6 m -15'			*7900 *17,400	7350 16,200	*5250 *11,500	3900 8,600					*4950 *10,900	3700 8,100	

*Load is limited by hydraulic capacity rather than tipping. Ratings are based on SAE standard No. J1097. Rated loads do not exceed 87% of hydraulic lift capacity or 75% of tipping load.

PC160LC-8 HYDRAULIC EXCAVATOR

LIFTING CAPACITIES



LIFTING CAPACITY

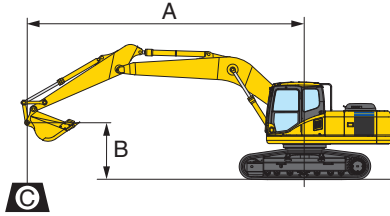

- A: Reach from swing center
- B: Bucket hook height
- C: Lifting capacity
- Cf: Rating over front
- Cs: Rating over side
- ☉: Rating at maximum reach

Conditions:

- Arm: 2610 mm **8'7"**
- Boom length 5150 mm **16'11"**
- Bucket 0.65 m³ **0.85 yd³** (SAE heaped)
- Bucket weight: 500 kg **1,100 lb.**
- Lifting mode: On

PC160LC-8		Shoe 800 mm 31.5"										Unit: kg/lb	
B	A	1.5 m 5'		3.0 m 10'		4.6 m 15'		6.1 m 20'		7.6 m 25'		☉ MAX	
		Cf	Cs	Cf	Cs	Cf	Cs	Cf	Cs	Cf	Cs	Cf	Cs
7.6 m 25'												*2250 *5,000	*2250 *5,000
6.1 m 20'								*3050 *6,800	2950 6,500			*2000 *4,400	*2000 *4,400
4.6 m 15'								*4150 *9,100	2900 6,400			*2000 *4,400	*2000 *4,400
3.0 m 10'				*8450 *18,600	*8450 *18,600	*5750 *12,700	4450 9,800	4550 10,100	2750 6,100	*2750 *6,100	1850 4,100	*2050 *4,600	1750 3,900
1.5 m 5'				*8500 *18,800	7500 16,500	7000 15,500	4100 9,000	4400 9,700	2600 5,800	3050 6,700	1800 3,900	*2250 *5,000	1650 3,700
0 m 0'				*7650 *16,900	7100 15,600	6700 14,800	3850 8,500	4250 9,400	2500 5,500	3000 6,600	1750 3,800	*2650 *5,900	1700 3,700
-1.5 m -5'		*5900 *13,000	*5900 *13,000	*10500 *23,200	7050 15,500	6600 14,600	3750 8,200	4200 9,200	2400 5,300			3250 7,100	1850 4,100
-3.0 m -10'		*9400 *20,700	*9400 *20,700	*10900 *24,100	7150 15,800	6650 14,600	3750 8,300	4200 9,300	2450 5,400			4000 8,900	2350 5,200
-4.6 m -15'				*7900 *17,400	7450 16,500	*5250 *11,500	3950 8,700					*4950 *10,900	3750 8,300

*Load is limited by hydraulic capacity rather than tipping. Ratings are based on SAE standard No. J1097. Rated loads do not exceed 87% of hydraulic lift capacity or 75% of tipping load.



LIFTING CAPACITY

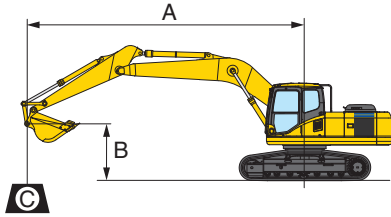

- A: Reach from swing center
- B: Bucket hook height
- C: Lifting capacity
- Cf: Rating over front
- Cs: Rating over side
- ⊗: Rating at maximum reach

Conditions:

- Arm: 2900 mm 9'6"
- Boom length 5150 mm 16'11"
- Bucket 0.65 m³ 0.85 yd³ (SAE heaped)
–Bucket weight: 500 kg 1,100 lb.
- Lifting mode: On

PC160LC-8		Shoe 600 mm 24"										Unit: kg/lb	
A \ B	1.5 m 5'		3.0 m 10'		4.6 m 15'		6.1 m 20'		7.6 m 25'		⊗ MAX		
	Cf	Cs	Cf	Cs	Cf	Cs	Cf	Cs	Cf	Cs	Cf	Cs	
7.6 m 25'											*1950 *4,300	*1950 *4,300	
6.1 m 20'							*3100 *6,800	2900 6,400			*1750 *3,800	*1750 *3,800	
4.6 m 15'							*3900 *8,600	2850 6,300	*1750 *3,900	*1750 *3,900	*1700 *3,800	*1700 *3,800	
3.0 m 10'			*7600 *16,800	*7600 *16,800	*5400 *11,900	4350 9,600	4450 9,800	2700 5,900	3000 6,600	1750 3,900	*1800 *3,900	1650 3,600	
1.5 m 5'			*10900 *24,100	7400 16,300	*6850 *15,100	4000 8,800	4250 9,400	2500 5,600	2900 6,400	1700 3,700	*1950 *4,300	1450 3,300	
0 m 0'			*7950 *17,500	6650 15,100	6500 14,300	3700 8,100	4100 9,000	2350 5,200	2850 6,300	1650 3,600	*2250 *5,000	1500 3,300	
-1.5 m -5'	*5500 *12,100	*5500 *12,100	*10050 *22,200	6750 14,900	6350 14,000	3550 7,800	4000 8,800	2300 5,000			*2850 *6,300	1650 3,600	
-3.0 m -10'	*8550 *18,900	*8550 *18,900	*11250 *24,800	6850 15,100	6350 14,000	3550 7,800	4000 8,800	2300 5,100			3500 7,800	2000 4,500	
-4.6 m -15'			*8600 *19,000	7100 15,700	*5800 *12,800	3700 8,200					*4800 *10,600	3100 6,800	

PC160LC-8		Shoe 700 mm 28"										Unit: kg/lb	
A \ B	1.5 m 5'		3.0 m 10'		4.6 m 15'		6.1 m 20'		7.6 m 25'		⊗ MAX		
	Cf	Cs	Cf	Cs	Cf	Cs	Cf	Cs	Cf	Cs	Cf	Cs	
7.6 m 25'											*1950 *4,300	*1950 *4,300	
6.1 m 20'							*3100 *6,800	2950 6,500			*1750 *3,800	*1750 *3,800	
4.6 m 15'							*3900 *8,600	2850 6,300	*1750 *3,900	*1750 *3,900	*1700 *3,800	*1700 *3,800	
3.0 m 10'			*7600 *16,800	*7600 *16,800	*5400 *11,900	4400 9,700	*4450 *9,800	2750 6,000	3050 6,700	1800 4,000	*1800 *3,900	1600 3,500	
1.5 m 5'			*10900 *24,100	7500 16,500	*6850 *15,100	4050 8,900	4300 9,500	2550 5,600	2950 6,600	1750 3,800	*1950 *4,300	1500 3,300	
0 m 0'			*7950 *17,500	6950 15,300	6600 14,600	3750 8,300	4150 9,200	2400 5,300	2900 6,400	1650 3,700	*2250 *5,000	1500 3,400	
-1.5 m -5'	*5500 *12,100	*5500 *12,100	*10050 *22,200	6850 15,100	6450 14,200	3600 8,000	4050 9,000	2350 5,100			*2850 *6,300	1650 3,700	
-3.0 m -10'	*8550 *18,900	*8550 *18,900	*11250 *24,800	6950 15,300	6450 14,200	3600 8,000	4050 9,000	2350 5,100			3600 7,900	2050 4,500	
-4.6 m -15'			*8600 *19,000	7200 15,900	*5800 *12,800	3750 8,300					*4800 *10,600	3150 6,900	

*Load is limited by hydraulic capacity rather than tipping. Ratings are based on SAE standard No. J1097. Rated loads do not exceed 87% of hydraulic lift capacity or 75% of tipping load.

PC160LC-8 HYDRAULIC EXCAVATOR

LIFTING CAPACITIES



LIFTING CAPACITY

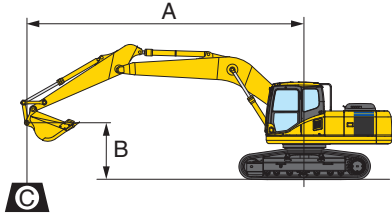

- A: Reach from swing center
- B: Bucket hook height
- C: Lifting capacity
- Cf: Rating over front
- Cs: Rating over side
- ☉: Rating at maximum reach

Conditions:

- Arm: 2900 mm 9'6"
- Boom length 5150 mm 16'11"
- Bucket 0.65 m³ 0.85 yd³ (SAE heaped)
–Bucket weight: 500 kg 1,100 lb.
- Lifting mode: On

PC160LC-8		Shoe 800 mm 31.5"										Unit: kg/lb	
B	A	1.5 m 5'		3.0 m 10'		4.6 m 15'		6.1 m 20'		7.6 m 25'		☉ MAX	
		Cf	Cs	Cf	Cs	Cf	Cs	Cf	Cs	Cf	Cs	Cf	Cs
7.6 m 25'												*1950 *4,300	*1950 *4,300
6.1 m 20'								*3100 *6,800	2950 6,500			*1750 *3,800	*1750 *3,800
4.6 m 15'								*3900 *8,600	2900 6,400	*1750 *3,900	*1750 *3,900	*1700 *3,800	*1700 *3,800
3.0 m 10'			*7600 *16,800	*7600 *16,800	*5400 *11,900	4500 9,900	*4450 *9,800	2750 6,100	3100 6,800	1850 4,000		*1800 *3,900	1650 3,600
1.5 m 5'			*10900 *24,100	7600 16,700	*6850 *15,100	4100 9,000	4400 9,700	2600 5,700	3000 6,700	1750 3,900		*1950 *4,300	1550 3,400
0 m 0'			*7950 *17,500	7050 15,500	6700 14,800	3800 8,400	4200 9,300	2450 5,400	2950 6,500	1700 3,700		*2250 *5,000	1550 3,400
-1.5 m -5'		*5500 *12,100	*5500 *12,100	*10050 *22,200	6950 15,300	6550 14,400	3650 8,100	4100 9,100	2350 5,200			*2850 *6,300	1700 3,800
-3.0 m -10'		*8550 *18,900	*8550 *18,900	*11250 *24,800	7050 15,500	6550 14,400	3650 8,100	4150 9,100	2350 5,200			3650 8,000	2100 4,600
-4.6 m -15'				*8600 *19,000	7300 16,100	*5800 *12,800	3800 8,400					*4800 *10,600	3200 7,000

*Load is limited by hydraulic capacity rather than tipping. Ratings are based on SAE standard No. J1097. Rated loads do not exceed 87% of hydraulic lift capacity or 75% of tipping load.



STANDARD EQUIPMENT

- Automatic air conditioner with defroster
- Alternator, 60 Ampere, 24 V
- Auto-decel
- Automatic engine warm-up system
- Batteries, large capacity, 2 x 12 V, 110 Ah
- Boom and arm holding valves
- Cab
- Converter, 12 V
- Counterweight, 2850 kg **6280 lb**
- Dry type air cleaner, double element
- Electric horn
- Engine, Komatsu SAA4D107E-1
- Engine overheat prevention system
- Equipment Management Monitoring System (EMMS)
- Fan guard structure
- High pressure in-line hydraulic filters
- Hydraulic track adjusters (each side)
- KOMTRAX®
- Long lubricating intervals for work equipment bushings (500 hours)
- Multi-function color monitor
- Operator Protective Top Guard (OPG) Level 1
- Power maximizing system
- PPC hydraulic control system
- Radiator and oil cooler dustproof net
- Rear reflector
- Rearview mirrors (LH & RH (2 pieces))
- Rear-view monitoring system
- Revolving frame deck guard
- Seat belt 76 mm **3"**, retractable
- Service valve (1 additional)
- Slip-resistant plates
- Starting motor, 4.5 kW/24 V x 1
- Suction fan
- Suspension seat
- Track frame undercover
- Track guiding guard, center section
- Track rollers: 7 each side
- Track shoes: 600 mm **24"** triple grouser
- Travel alarm
- Work lights, 2 (boom and RH)
- Work mode selection system



OPTIONAL EQUIPMENT

- Arms
 - 2900 mm **9'6"** arm assembly
 - 2610 mm **8'7"** arm assembly
 - 2900 mm **9'6"** arm w/ one actuator piping
 - 2610 mm **8'7"** arm w/ one actuator piping
- Boom
 - 5150 mm **16'11"** boom assembly
 - 5150 mm **16'11"** boom w/ one actuator piping
- Full front guard, Level 2
- One actuator hydraulic control unit
- OPG top guard, Level 2, bolt-on
- Pattern change valve (ISO to BH)
- Rain visor
- Shoes, triple grouser
 - 700 mm **28"**
 - 800 mm **31.5"**
- Sun visor



ATTACHMENT OPTIONS

- JRB attachments
 - Couplers
 - Smart-Loc
 - Versa-Loc
- Komatsu buckets
- PSM thumbs
- Rockland thumbs
- Rubber track shoes, Bolt-on type

For a complete list of available attachments, please contact your local Komatsu distributor.



AESS790-00

©2010 Komatsu America Corp.

Printed in USA

D01(2.5M)C

01/10 (EV-1)

KOMATSU[®]

www.KomatsuAmerica.com



Komatsu America Corp. is an authorized licensee of Komatsu Ltd. Materials and specifications are subject to change without notice. **KOMATSU** is a registered trademark of Komatsu Ltd., Japan. **KOMTRAX** is a registered trademark of Komatsu America Corp.