



# DISC MOWERS

Compact angle drive

- ▶ Professional
- ▶ Powerful
- ▶ Cost-effective



[fella.eu](http://fella.eu)

*Harvesting  
Energy!*

## FIRST-RATE HARVEST

For more than 95 years, FELLA has always meant innovative technology, outstanding quality and personal passion in the service of agriculture. As the specialist for "Made in Germany" forage harvesting technology, we offer our customers all around the world an extremely wide range of products in terms of mowers, rakes, hay tedders and conditioners.

FELLA has been represented in all important markets around the world since the 1980s. Through close contact with farmers and agricultural contractors, our machines are constantly undergoing further development towards perfection. In this way, even the most diverse markets can enjoy mutual benefits. FELLA's objective is to provide every customer with the optimum solution for their farm and their requirements.



## TRADITION, INNOVATION, PASSION

The first grass mower was produced on our company site in Feucht as early as 1932. All key components of our forage harvesting machines are assembled and tested by specialists before they leave our works.

At the same time, our research and development department continues to invest all its expertise into the development of ever better and more efficient machines. This will guarantee the outstanding FELLA "Made in Germany" quality far into the future for all our customers the world over.

### FELLA - the forage harvesting specialist:

- ▶ "Made in Germany" quality
- ▶ More than 95 years of experience
- ▶ In-house research and development department
- ▶ All machines are assembled and tested on the company's site by specialists
- ▶ Innovative, efficient, long-lasting

## HISTORY

The name FELLA has been a byword for innovative agricultural machinery from Franconia for over 95 years. FELLA-Werke GmbH of Feucht near Nuremberg currently holds a top position in the demanding crop harvesting machinery sector. With a comprehensive range of drum and disc mower machines, tedders and rakes, FELLA is in an excellent position to enjoy sustainable growth on the world market.

Since early 2011, FELLA has been fully incorporated into the AGCO Corporation and will continue to drive forward the specialisation of harvest technology for them. The Feucht site, near Nuremberg, is AGCO's centre of excellence for green forage harvesting in Europe.

### AN OVERVIEW OF OUR HISTORY

- ▶ 1918 Founding of "Bayerische Eggenfabrik AG" in Feucht
- ▶ 1921 The brand name FELLA is created, derived from the Egyptian word "Fellache" (= farmer)
- ▶ 1923 Ploughs and front carriages are incorporated in the product range
- ▶ 1932 Introduction of grass mowers, hay tedders, horse rakes and reaper-binders to the product portfolio
- ▶ 1953 FELLA brings its first conditioner with tine rotor to the market. It is awarded with the *große Bronzene Preismedaille* (great bronze medal) by the DLG (German Agricultural Association)
- ▶ 1954 With the Jupiter, FELLA brings an automatic, powerful combine harvester to market
- ▶ 1968 Introduction of rakes to the product portfolio
- ▶ 1980 Specialisation of products for green forage harvesting
- ▶ 1989 Concentration on the core competences of construction, assembly, sales
- ▶ 1997 The principle of the four "self-controlling factories" is introduced. Two years later, it is awarded with the International Best Factory Award
- ▶ 2000 Investment in the "new" FELLA (new building, restructuring)
- ▶ 2004 Takeover of FELLA by Argo, FELLA becomes a 100% subsidiary of Laverda
- ▶ 2007 Argo and AGCO conclude a joint venture, each with a 50% share, FELLA becomes a part of both companies
- ▶ 2011 100% takeover by AGCO: FELLA becomes the competence centre for green forage harvesting of AGCO in Europe
- ▶ 2013 FELLA's 95th anniversary

## SERVICE

"Out of sight, out of mind." But not at FELLA!

Together with our dealers, we are always there and ready to provide reliable support to our partners, both at home and abroad – as we have been doing now for almost 100 years. In conjunction with our well organised spare parts stores, regular further technical training for our dealers ensures that FELLA machines can be used, maintained and repaired to a professional standard. This comprehensive service ensures a high level of deployment reliability for your FELLA machines and makes a significant contribution to high-yield and stress-free forage harvesting.



95 YEARS OF FELLA

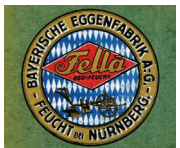

## DISC MOWERS WITH COMPACT ANGLE DRIVE



### WHY CHOOSE A FELLA DISC MOWER WITH COMPACT ANGLE DRIVE?

Professional, powerful and cost-effective – these are the distinguishing features of the FELLA disc mower with compact angle drive. They are ideal for use in all regions and harvesting conditions. The recovery of high-quality and clean forage is ensured by the precise cut. A durable design goes without saying in just the same way as the low maintenance requirements. See for yourself.



### At a glance:

- ▶ Tried and tested compact angle drive for use in all conditions
- ▶ Profiled cutter bar for perfect flow and, as a result, clean forage
- ▶ Precise cut due to the large overcut of the mower discs
- ▶ Cost-effectiveness due to the easy-to-assemble structure of the bar
- ▶ All machines manufactured from high-quality materials and all components powder coated – colour coating particularly impact resistant and long-lasting, providing a brilliant look which lasts for years

### Opinions based on actual use:

"I am impressed by FELLA's grassland technology. The working width of my SM 911 TL-KCB mower combination is 8.30 metres. I am particularly impressed by the butterfly mower's high cutting power, which in turn is the basis for the highest-quality forage. Another great advantage is the machine's low drag, as well as the exact swath gathering using the deposit belts. The mower combination is equipped with a tine-rotor conditioner, which results in green waste being prepared gently. When cornering and operating on slopes, we take the opportunity to move the SM 310 FZ-KC front-mounted mower laterally using hydraulics – this allows us to work very precisely and cleanly. Even today, I would still choose a butterfly mower from FELLA."

Ferdinand Staiger, 78600 Kolblingen, Germany"



## THE SECRET TO A PERFECT CUT

### THE COMPACT ANGLE DRIVE

The cutter bar with compact angle drive was developed over 20 years ago and based on components from other FELLA machines that were tried and tested a thousand times over. The features at the heart of this system are a continuous, large-dimensioned hexagonal shaft and a robust angular gearbox under each mower disc. This results in even power distribution to all mower discs and the smoothing of torque peaks. The load and the wear of the components is significantly lower when compared to the conventional spur gear bar. The components are screwed to a robust, yet flexible, unit. Due to its unique design, the FELLA disc mowers with compact angle drive have low power-loss and are durable, therefore making an important contribution to the cost-effectiveness of your mowing, particularly in times when the cost of fuel is always increasing.

### THE PERFECT CUTTER BAR: THE SHAPE MAKES ALL THE DIFFERENCE

The cutter bar determines whether you harvest quality forage. The engineers at FELLA have succeeded in developing a perfectly streamlined cutter bar with profiles on the underside. As a result, even in adverse conditions, this prevents the formation of mounds of soil in field forage crops or on wetland. The soil is cleanly separated from the forage and flows away under the cutter bar. This removes the possibility of the soil mixing in with your high-quality forage. With a FELLA cutter bar, you can then continue to work when others have already had to give up or have not even been able to start working.

### THE CUT IS WHAT COUNTS

A perfect cut is achieved due to the large overlap of the mower discs which is positioned well towards the front. This is a result of the large mower discs which FELLA use. Due to their special shape, these improve the flow of forage across the mower bed – an important aspect, especially for heavy, lying material. A clean cutting pattern – the calling card of any FELLA mower!

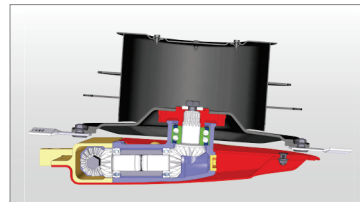

The cutter discs are driven "indirectly" by means of a hexagonal shaft and compact angular gears

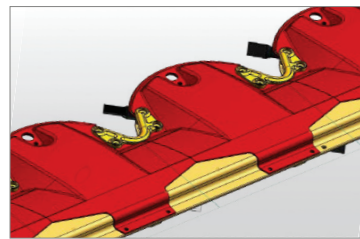

Streamline cutter bar with profiled base and hardened track skids

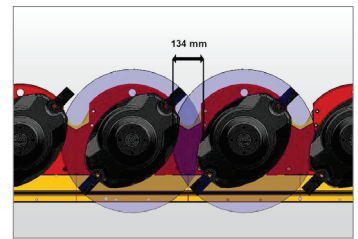

Large overlap of disc cutting area

Low power requirement – huge area output!

## TYPICAL FEATURES OF THE COMPACT ANGLE DRIVE

### EVERYTHING IS WELL THOUGHT-OUT - FOR A HIGH LEVEL OF OPERATIONAL RELIABILITY AND LOW OPERATING COSTS

Even as early as when the cutter bar was being designed, our engineers worked with foresight. As a result, the hexagonal shaft was provided with a predetermined breaking point which interrupts the flow of power between the cutter bar and the tractor if there is a heavy overload. That saves you having to pay for expensive repairs.

The cutter bar has been designed for ease of service. The compact angle drives, the skids and the counter-cutter are bolt-fitted and can be replaced easily and quickly, as required.

Due to its lifetime oil filling, the cutter bar is largely maintenance-free and the lubrication of the cutter bar is ensured in any mowing situation.

The best basis for a worry-free harvest!

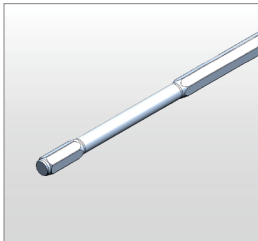

Hexagonal shaft with predetermined shear point

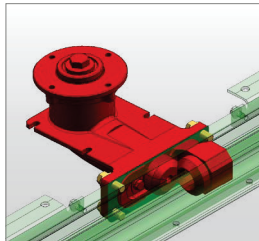

Easy to assemble cutter bar design

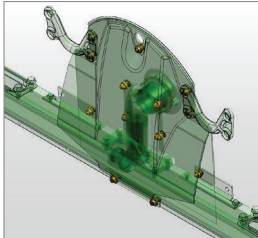

Bolt-fit design

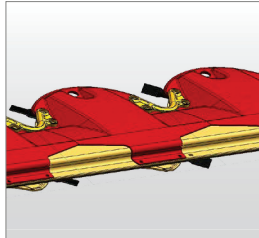

Streamlined cutterbar

### At a glance:

- ▶ Hexagonal drive shaft with predetermined shear point
- ▶ Easy to service cutter bar design thanks to bolt-fitted, easily replaceable components
- ▶ Cutter bar lifetime oil filling

### TOWARDS-CENTRE OR PAIRED RUNNING

Due to the screwed-in compact angle drive, you can specially adjust the direction of rotation to meet your individual needs - even after many years. The mower discs are converted from axial running to paired running by simply switching over two angle drives - all without any additional components.

You can flexibly adapt your FELLA mower to changing general conditions. Whatever comes your way: you always have the right mowing technology.

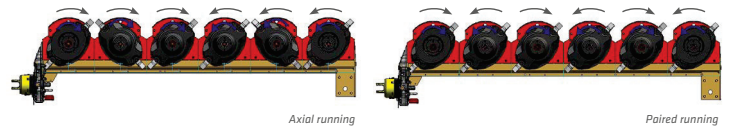

Axial running

Paired running

### THE SUPPORT FRAME - THE BACKBONE OF ANY MOWER

The cutter bar is supported and guided by the support frame. This is manufactured from high-quality, warp-resistant steel and is designed for extremely heavy loads. The FELLA design is particularly characterised by sturdiness and durability.

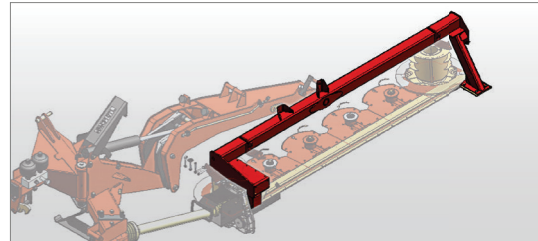

Support frame

### At a glance:

- ▶ Power train protected using a drive shaft with freewheel and overload protection\*
- ▶ Support frame made from warp-resistant steel
- ▶ Axial or paired running of the mower discs

\* model-specific

## driveGUARD

### THE INNOVATIVE OVERLOAD PROTECTION SYSTEM FOR YOUR DISC MOWER

Every farmer knows from experience that foreign objects on agricultural land that are accidentally drawn into the mower along with the crop can cause significant damage.

With its brand new **driveGUARD**, a industry leading overload protection system, FELLA prevents precisely this kind of costly damage!

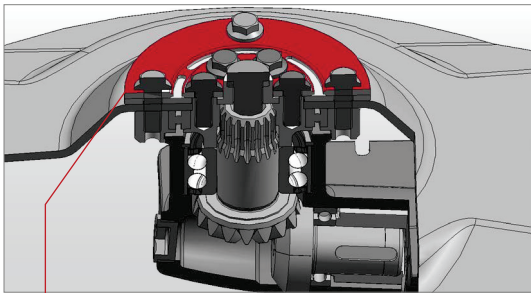

driveGUARD protects your mower: simple, ingenious and cost-effective!

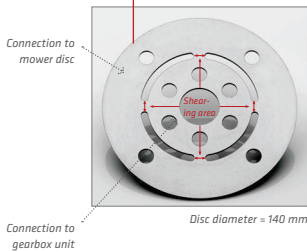

machine type	driveGUARD as standard
SM 210 FK/FK-S	
SM 260 FK	
SM 260 FP/FP-S	
SM 310 FP-K/FP/FP-SL/FP-KC/FP-RC	■
SM 310 FZ/FZ-KC/FZ-RC	■
SM 210/270/320/350	
SM 3060/3570/4080/4590 TL	■
SM 310 TL-KC/TL-RC	■
SM 911 TL/TL-KC/TL-RC/TL-KCB	■
SM 991 TL/TL-KC/TL-KCB	■
SM 8312 TL-RCB / SM 9314 TL-KCB	■
SM 313 Trans/Trans-KC/Trans-RC	■
SM 3065/3575 Trans-KC/Trans-RC	■
SM 311 Trans/Trans-KC/Trans-RC	■
SM 401 Trans/Trans-KC/Trans-RC	■

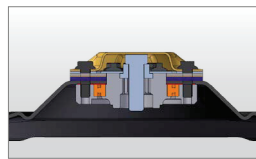

#### BETTER PROTECTED THAN EVER

If the mower disc is jammed by a foreign object, **driveGUARD** shears off the predetermined breaking points. This interrupts the power train, and the mower disc turns freely. No shock loads reach the mower power train as they would if the **driveGUARD** is not there, preventing costly repairs. The mower disc remains firmly connected at all times with the cutter bar via the outer part of the profile flange. Loss of the mower disc is safely prevented.



#### INTELLIGENT ATTACHMENT

By positioning **driveGUARD** outside of the cutter bar, expensive damage to the gearbox, long downtimes and contamination of the oil bath are prevented.



#### NOTHING IS MORE COST-EFFECTIVE

**driveGUARD** provides the customer with a very reasonably priced protection system because, when a replacement is required, only the overload disc has to be changed.



#### SIMPLE YET INGENIOUS

Should you need to, you can replace the **driveGUARD** in the field in a matter of minutes. You do not need to open the cutter bar, because the **driveGUARD** is mounted on the mower disc, outside the cutter bar.



### ADVANTAGES:

- ▶ Protection of the entire mower drive
- ▶ Shorter downtimes
- ▶ The **driveGUARD** disc can be changed quickly and easily out in the field
- ▶ It is possible to retrofit existing machines without any problems
- ▶ It is possible to change the **driveGUARD** without opening the entire cutter bar
- ▶ The cutting disc remains securely attached to the cutter bar at all times

#### SAVE BOTH TIME AND MONEY:

You simply need only to change the **driveGUARD** disc when necessary. It is possible to do this within minutes out in the field and you can do it yourself.

## FELLA PATENTS FOR COMFORTABLE HARVESTING

### TURBOLIFT - ALWAYS THE RIGHT GROUND CONTACT PRESSURE

The FELLA TurboLift system relieves the hydropneumatic load on the cutter bar. This system makes use of an innovative control device which makes any adjustments to the contact pressure possible – quick, simple and with no need for tools. In addition, the system is automatically calibrated at every headland and, as a result, any undesired change to the ground contact pressure is immediately corrected. All of this can be monitored and controlled from the comfort of the tractor seat. Climbing down from the tractor and the use of a tool – not with FELLA!

Due to the floating cut, the cutter bar is extremely well suited to the most wide-ranging operating conditions. The easy-to-use reduction of the contact pressure when passing through damp or wet areas prevents the forage from becoming contaminated and also ensures that the sward remains undamaged.

In addition, the frame structure and the skids carry less of a load, meaning less wear and drag resistance reducing tractor fuel consumption.

Perfect ground following, combined with increased cost-effectiveness has just one name: FELLA TurboLift!

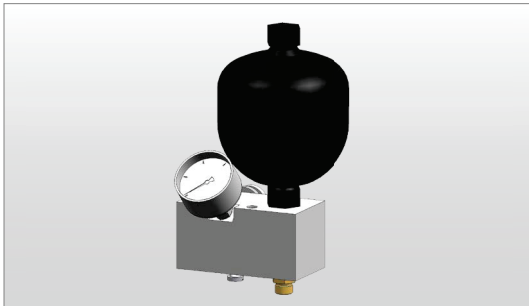

TurboLift system

### At a glance:

- ▶ Relieves the hydropneumatic load
- ▶ Ground contact pressure can be adjusted while driving
- ▶ Automatic calibration every headland
- ▶ Perfect monitoring from the tractor seat – no need to climb down from the tractor
- ▶ Floating cut – perfect adjustment of the cutter bar
- ▶ Conservation of the sward – very low level of forage contamination

### SAFETYSWING - MORE SECURITY FOR YOUR MACHINE

The patented SafetySwing impact guard provides optimum safety in any field and reliably protects your machine from damage caused by striking obstructions. If the mower encounters an obstacle, it will fold back and up and then automatically returns to its original position under its own weight. Each mower unit is protected separately and can therefore separately swing out of the way.

Another special feature of the SafetySwing: The pivotal point of the mower unit is positioned exactly in the centre of the three-point headstock and therefore guarantees a maximum possible leverage. As a result, the mechanism is activated, even if you hit an obstacle with one of the inner mower discs.

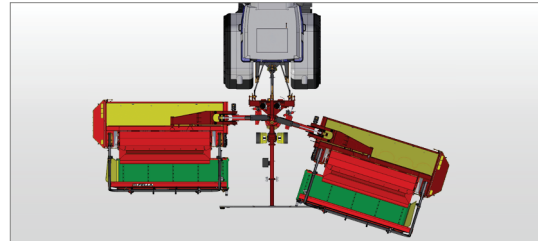

Swing backwards

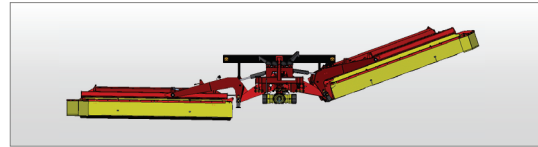

Swing upwards

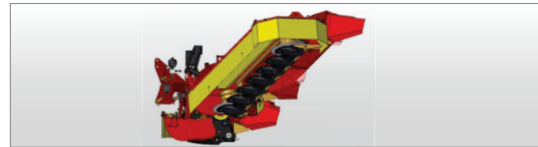

Re-engagement due to own weight



### At a glance:

- ▶ SafetySwing – patented impact guard
- ▶ If there is an obstacle, the mower folds backwards and upwards
- ▶ Automatic re-engagement into working position
- ▶ Reliable protection against damage

## CONTENT OVERVIEW

### DISC MOWERS WITH COMPACT ANGLE DRIVE

#### Pages 18–19

##### ALPIN FRONT-MOUNTED DISC MOWERS



#### Pages 20–23

##### FRONT-MOUNTED DISC MOWERS



#### Pages 26–31

##### REAR-MOUNTED DISC MOWERS

- ▶ laterally hitched (SM 210–350)
- ▶ centrally hitched (SM 310 TL-KC–SM 4590 TL)



#### MACHINE DESIGNATIONS AND ABBREVIATIONS

- ▶ SM: Disc mowers
- ▶ FK: Front-mounted compact headstock
- ▶ FP: Front-mounted oscillating linkage
- ▶ FP-K: Short front-mounted oscillating linkage
- ▶ FZ: Front headstock with trailing linkage
- ▶ TL: TurboLift System
- ▶ Trans: Transport chassis
- ▶ D: Three-point headstock
- ▶ B: Belt
- ▶ SL: Driven rake
- ▶ KC: Tine-rotor conditioner
- ▶ RC: Roller conditioner

Machine designation	SM 210 FK	SM 210 FK-S	SM 260 FK	SM 260 FP	SM 260 FP-S
Approx. working width in m	2.05	2.05	2.50	2.50	2.50
Approx. swath width in m	1.10	1.10	1.35	1.35	1.35
Approx. weight in kg	369	373	410	474	504
Approx. power requirement in kW/hp	19/26	19/26	22/30	28/38	28/38

Machine designation	SM 310 FP	SM 310 FP-K	SM 310 FP-SL	SM 310 FP-KC	SM 310 FP-RC
Approx. working width in m	3.00	3.00	3.00	3.00	3.00
Approx. swath width in m	2.00	2.00	<1.10	1.45–2.20	1.55–1.90
Approx. weight in kg	734	694	854	954	1,006
Approx. power requirement in kW/hp	55/75	56/75	55/75	66/90	64/87

Machine designation	SM 310 FZ	SM 310 FZ-KC	SM 310 FZ-RC
Approx. working width in m	3.00	3.00	3.00
Approx. swath width in m	2.00	1.45–2.20	1.55–1.90
Approx. weight in kg	930	1,150	1,202
Approx. power requirement in kW/hp	55/75	66/90	64/87

Machine designation	SM 210	SM 210 KC	SM 210 RC	SM 270	SM 270 KC	SM 270 RC	SM 320	SM 320 KC
Approx. working width in m	2.05	2.05	2.05	2.55	2.55	2.55	3.00	3.00
Approx. swath width in m	1.10	0.40–0.95	0.55–0.90	1.60	0.90–1.40	1.05–1.40	1.80	1.35–1.90
Approx. weight in kg	612	782	835	630	883	980	724	1,011
Approx. power requirement in kW/hp	36/49	48/65	48/65	40/54	55/75	55/75	45/61	63/86

Machine designation	SM 350	SM 3060 TL	SM 3570 TL	SM 4080 TL	SM 4590 TL	SM 310 TL-KC	SM 310 TL-RC
Approx. working width in m	3.50	3.00	3.50	4.00	4.50	3.00	3.00
Approx. swath width in m	2.30	2.30	2.80	3.30	3.80	1.45–2.25	1.55–1.90
Approx. weight in kg	798	875	950	980	1,100	1,228	1,264
Approx. power requirement in kW/hp	50/68	55/75	65/88	72/99	84/115	63/86	63/86

## CONTENT OVERVIEW DISC MOWERS WITH COMPACT ANGLE DRIVE

### Pages 34–39 MOWER COMBINATIONS



Machine designation	SM 911 TL	SM 911 TL-KC	SM 911 TL-RC	SM 911 TL-KCB	SM 991 TL	SM 991 TL-KC	SM 991 TL-KCB
Approx. working width in m	8.30	8.30	8.30	8.30	9.30	9.30	9.30
Approx. swath width in m	2x2.00	2x1.45–2.25	2x1.55–1.90	2x1.80–2.50	2x2.50	2x1.85–3.25	2x2.20–2.50
Approx. weight in kg	1,966	2,410	2,508	2,901	2,120	2,830	3,200
Approx. power requirement in kW/hp	110/150	132/180	128/175	145/200	130/175	155/200	168/228

Machine designation	SM 8312 TL-RCB	SM 9314 TL-KCB
Approx. working width in m	8.30	9.30
Approx. swath width in m	2x1.80–2.60	2x1.80–3.00
Approx. weight in kg	3,300	3,450
Approx. power requirement in kW/hp	141/182	168/228

### Pages 42–53 TRAILED MOWERS AND CONDITIONERS



Machine designation	SM 313 Trans	SM 313 Trans-KC	SM 313 Trans-RC	SM 3065 Trans-KC	SM 3065 Trans-RC	SM 3575 Trans-KC	SM 3575 Trans-RC
Approx. working width in m	3.00	3.00	3.00	3.00	3.00	3.50	3.50
Approx. swath width in m	2.00	0.90–2.25	1.55–1.90	0.80–2.00	0.80–2.00	1.20–2.60	1.20–2.60
Approx. weight in kg	1,690	1,945	1,962	2,388	2,365	2,560	2,527
Approx. power requirement in kW/hp	55/74	66/90	66/90	75/102	75/102	88/120	88/120

Machine designation	SM 311 Trans	SM 311 Trans-KC	SM 311 Trans-RC	SM 401 Trans	SM 401 Trans-KC	SM 401 Trans-RC
Approx. working width in m	3.00	3.00	3.00	4.00	4.00	4.00
Approx. swath width in m	2.00	1.45–2.25	1.55–1.90	2x1.05	2x0.50–1.25	2x0.60–0.95
Approx. weight in kg	1,458	1,678	1,730	1,633	1,928	1,988
Approx. power requirement in kW/hp	55/74	66/90	66/90	73/99	80/115	80/120

Machine designation	KC 275 D
Approx. working width in m	1.73
Shaft speed rpm	540/1,000
Approx. weight in kg	398
Approx. power requirement in kW/hp	15/20



## FIRST-RATE HARVEST!

Based on tradition, innovation and passion.

Front-mounted disc mowers from FELLA



## FRONT-MOUNTED ALPIN

SM 210 FK  
SM 210 FK-S  
SM 260 FK  
SM 260 FP  
SM 260 FP-S

- ▶ Specially developed for use on alpine terrain
- ▶ Swinging hitch
- ▶ Mowing on sloping terrain without loss of forage



SM 210 FK-S



Four mower discs for symmetrically central running

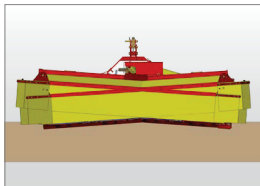

Pendulum swing +/- 4°

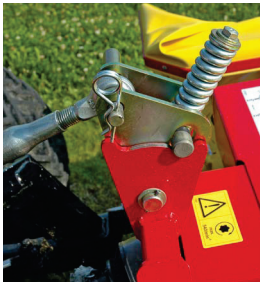

Spring-loaded impact guard system



Short attachment headstock

### SPECIALISTS FOR ALPINE USE

To also meet the demands of farmers in alpine regions, FELLA has developed the SM 200 series disc mowers. These are unique with their short, compact linkage. As a result, the centre of gravity lies close to the tractor and this leads to very good track stability on sloping terrain. Due to the centre pivoting hitch (+/- 4°) of the mower, optimum ground following is ensured.

You have the choice between two linkage systems on the tractor:

- ▶ FK: extremely short linkage directly on the lower link of the alpine tractors
- ▶ FP: compact linkage using a mounting triangle on standard tractors

### MOWING ON SLOPING TERRAIN - WITHOUT LOSS OF FORAGE

With the SM 210 FK-S and SM 260 FP-S mowers, you can also mow on the steepest alpine terrain or in the hillside line without losing forage. Due to the option to move the mower by up to 12 cm (SM 210 FK-S) and 20 cm (SM 260 FP-S) to the left or right, you can also mow with ease on sloping terrain using twin tyres without having to leave any forage behind.

### SWATH FORMATION ON SLOPING TERRAIN - NO PROBLEM

The four centrally running mower discs allow a very good and even swath deposit even on sloping terrain, yet still require no additional guiding equipment.

### OPTIMUM WEIGHT DISTRIBUTION - PERFECT FORAGE CONDITIONING

With the combined use of a front-mounted mower and a KC 275 D rear-mounted conditioner, you can achieve the greatest possible level of efficiency during forage harvesting in alpine areas. The optimum weight distribution leads to very good track stability, even on difficult sections. The forage is optimally prepared and loosely deposited – an important requirement for perfect quality forage.

### At a glance:

- ▶ Two variants: FK (rigid headrack) and FP (oscillating linkage)
- ▶ 4 mowers for symmetrically central running, which allows an even swath deposit and a very good conveying effect
- ▶ Very good track stability
- ▶ Folding side guard for narrow-width road travel
- ▶ Spring-loaded impact guard system with the FK version



SM 260 FP-S: steplessly hydraulically adjustable sideways (approx. 20 cm on either side)

## FRONT-MOUNTED OSCILLATING LINKAGE

SM 310  
SM 310 FP-K  
SM 310 FP-SL  
SM 310 FP-KC  
SM 310 FP-RC

► The all-rounders in the front-mounted mower range

► Wide pivot travel

► Available in many variants



SM 310 FP-KC

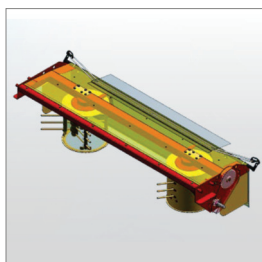

Rake

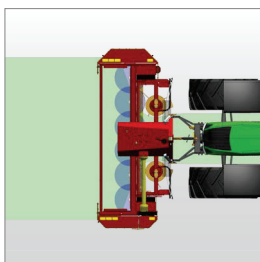

SM 310 FP-SL



SM 310 FP-K



SM 310 FP-K extremely compact attachment to the tractor

drive  
GUARD

### THE ALL-ROUND FRONT-MOUNTED MOWER

Due to the compact linkage on the FP mower, the centre of gravity lies very close to the tractor. This results in a low load for the tractor and machine, and prevents rocking, even when driving quickly on roads. The attachment and removal of the machine using a mounting triangle, which is extremely easy and quick to complete, is another advantage of this model. Additional hydraulic connections are not required.

### GOOD GROUND FOLLOWING – THE PIVOT TRAVEL MAKES THIS HAPPEN!

The mower is attached in the centre of gravity using a swinging axle. This leads to excellent ground following (+/- 6.5°) and reliably prevents contamination of your quality forage. The mechanical spring relief causes a lower ground contact pressure for the cutter bar across the entire working width. When driving on roads, the mower is automatically stabilised by a spring centring system, providing a high level of safety and maximum comfort.

### CONDITIONER – ACHIEVING QUALITY FORAGE MORE QUICKLY

The SM 310 FP front-mounted mower is also available with an optional roller conditioner (RC) or tine-rotor conditioner (KC). If you use a conditioner, you achieve your quality forage more quickly because the moisture loss from your plants is accelerated. This gives you a decisive time advantage, particularly in unstable weather conditions – a quicker and safer way to produce your quality forage.

### SL VERSION – FOR OPTIMUM SWATH FORMING THAT IS LESS IMPACTIVE FOR THE FORAGE

The swather variant with cam-controlled feed tines ensures swaths are deposited in defined, compact lines (> 1.10 m depending on type of forage and crop). The feed tines deposit a precisely shaped, lightly packed swath which is suitable for all pick-up widths. Swaths are placed between the tractor wheels at all times, preventing the forage from being driven over. This defined depositing of the swath is particularly convenient on inclines when working with hillside lines. You achieve the desired result – clean basic feed for your livestock.

### SM 310 FP-K – EXTREMELY COMPACT ATTACHMENT

The extremely compact attachment for the SM 310 FP-K ensures perfect ground adaptation, and since the centre of gravity is very close to the tractor, it is possible to operate it even using light tractors.

### At a glance:

- Compact linkage
- No hydraulic connection required
- Excellent ground adaptation
- Tine-rotor conditioner or roller conditioner
- Rake version
- FP-K: Design with extremely compact tractor attachment

### WE RECOMMEND\*:

- Swath disc for operating without a conditioner for depositing an even narrower swath
- ComfortChange quick-change blade system to safely replace blades without losing too much time

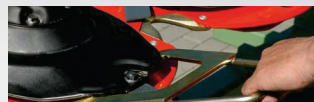
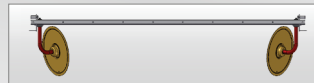

\*AS AN OPTION

## FRONT-MOUNTED HEADSTOCK WITH TRAILING LINKAGE

### SM 310 FZ SM 310 FZ-KC SM 310 FZ-RC

- ▶ Perfect for operating in mower combinations
- ▶ Hydraulic movement system for harvesting without losses
- ▶ Three-dimensional sensing of the ground contours



SM 310 FZ-RC

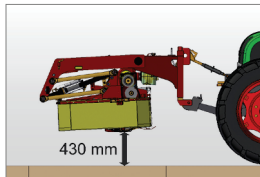

Large lifting height

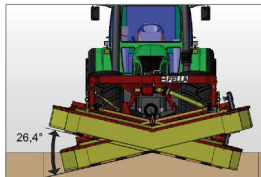

Large pivot angle



Transport position



### FRONT-MOUNTED MOWER WITH OUTSTANDING GROUND FOLLOWING

The SM 310 FZ front-mounted mower offers you the largest possible pivot travel, ensuring outstanding ground following, even under the most difficult harvesting conditions. The three-dimensional sensing of the ground contours allows you to mow an extremely wide range of materials without any losses. This machine is commendable due to its ability to move laterally, especially when used with mower combinations. If you use the optional hydraulic movement system, no blade of grass is left standing – even on sloping terrain and when cornering.

### ADAPTS VERY WELL TO GROUND CONTOURS

The cutter bar is mounted at the outermost points on the sturdy support frame. This in conjunction with the parallel following of the mower to uneven ground prevents the cutter bar digging into the soil ensuring top quality forage without contamination. Due to the specially developed trailed suspension mounting of the cutter bar, the ground pressure is reduced to a minimum – whatever the pivot movement.

### USER-FRIENDLY

The working height can be infinitely and conveniently adjusted by a central crank. As a result, you can react flexibly to changing working conditions. In addition, you can perfectly adapt the ground contact pressure of the mower to your conditions. Due to the generous lifting height of the mower, turning manoeuvres on the headland can be carried out seamlessly without causing any damage to transverse swaths.

### CONDITIONER – ACHIEVING QUALITY FORAGE MORE QUICKLY

The SM 310 FZ front-mounted mower is also available with an optional roller conditioner (RC) or tine-rotor conditioner (KC). If you use a conditioner, you achieve your quality forage more quickly because the moisture loss from your plants is accelerated. This gives you a decisive time advantage, particularly in unstable weather conditions – a quicker and safer way to produce your quality forage.

### At a glance:

- ▶ Largest pivot angle travel on the market
- ▶ Mower can be moved laterally
- ▶ Infinitely adjustable cutting height
- ▶ Adjustable ground contact pressure
- ▶ Tine-rotor conditioner or roller conditioner options

### WE RECOMMEND\*:

- ▶ Stone guard for RC machines; protects the cutter bar from stones
- ▶ Additional spring relief for a low contact pressure of the cutter bar

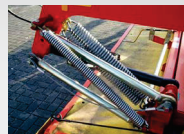
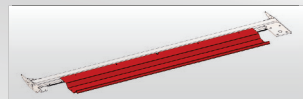

\*AS AN OPTION

# FIRST-RATE HARVEST!

Based on tradition, innovation and passion.

Rear-mounted disc mowers from FELLA



## REAR-MOUNTED THREE-POINT ATTACHMENT, SIDE HITCH ATTACHMENT

SM 210  
SM 210 KC  
SM 210 RC  
SM 270  
SM 270 KC  
SM 270 RC  
SM 320  
SM 320 KC  
SM 350

- ▶ Rear-mounted mower for medium power classes
- ▶ Controlled lifting kinematics
- ▶ Ease of handling



SM 270 KC



Transport position



Cover folded back

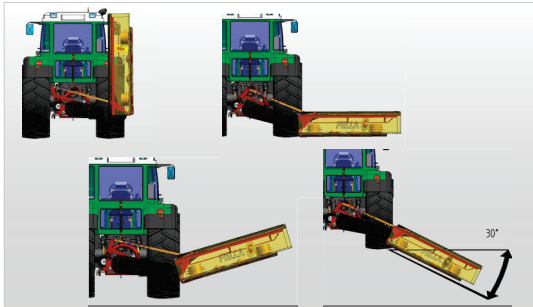

Controlled lifting kinematics

### REAR-MOUNTED MOWER WITH SIDE ATTACHMENT AND WIDE RANGE OF APPLICATIONS

These models are rear-mounted mowers with side attachment that are in the medium power class and are available in various versions. Typical features of the machines include the mechanical spring relief and the robust V-belt drive. An impact guard is as much part of standard equipment as the option of having track adaptation on a wide range of tractors. Special conveyor drums on the right and left of the mower and the automatic tensioner complete the equipment package.

### VERY USER-FRIENDLY

It could not be simpler to attach and remove the mower. The controlled lifting kinematics ensure that the cutter bar lifts in parallel to the ground on the headland, thus reliably preventing the mower from digging into the ground. The machine is easily operated using a single-acting hydraulic service – the position of the three-point linkage arms remain unchanged. The sturdy mower cover opens widely on both sides allowing optimum access for cleaning and maintenance work.

### CONDITIONER – ACHIEVING QUALITY FORAGE MORE QUICKLY

The SM 210, SM 270 and SM 320 disc mowers with side attachment are also available with a tine-rotor conditioner (KC), and the SM 210 and SM 270 disc mowers are also available with a roller conditioner (RC). If you use a conditioner, the moisture loss from the forage is accelerated. This gives you a decisive time advantage, particularly in unpredictable weather conditions – a quicker and safer way to produce your quality forage.

### At a glance:

- ▶ Mower for medium power classes
- ▶ Robust support frame
- ▶ Mechanical spring relief of the cutter bar
- ▶ Lateral hitching – downward ground adaptation possible (mowing on slopes)
- ▶ Impact guard
- ▶ Controlled lifting kinematics (very high lifting height at the headland), no activation of the three-point hydraulic system necessary on the headland
- ▶ Foldable protective sheets
- ▶ V-belt drive with automatic V-belt tensioning

Conditioners for retrofitting\*

### WE RECOMMEND\*:

- ▶ Additional skids for larger cutting heights and as wear protection for stony and sandy ground
- ▶ ComfortChange quick-change blade system to safely replace blades without losing too much time

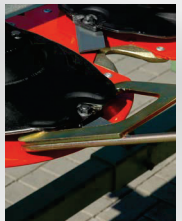
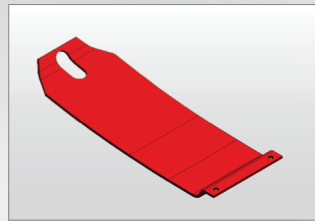

\* see also page 52

\*AS AN OPTION

## REAR-MOUNTED THREE-POINT ATTACHMENT, CENTRE HITCH ATTACHMENT

SM 3060 TL  
SM 3570 TL  
SM 4080 TL  
SM 4590 TL

- ▶ Efficient rear mowers without conditioner
- ▶ Very user-friendly
- ▶ Perfect ground contour following thanks to the FELLA patent



SM 3060 TL



Transport position



Cover folded back



TurboLift control device



Swivel gearbox



### REAR-MOUNTED MOWERS WITH MIDDLE ATTACHMENT AND WIDE RANGE OF APPLICATIONS

These models are specifically designed to meet the increasing demand for powerful rear-mounted mowers. Despite their large working width of up to 4.50 metres, the mowers are attached at their centre of gravity adapt to ground contours extremely well. The impact guard with pivoting gearbox ensures maximum safety against obstacles. The pivoting gearbox also provides the mower with a very wide angle of yield and ensures that the universal shaft is not damaged.

### OPTIMUM GUIDANCE OF THE CUTTER BAR THANKS TO THE FELLA PATENT

The FELLA patent provides optimum stability and guidance of the cutter bar both longitudinally and transversely. As a result, the lifting arm of the mower is relieved and the excellent ground adaptation is reinforced. In addition, your sward is protected against damage and this therefore prevents your forage from becoming contaminated – the perfect prerequisite for your quality forage.

### USER-FRIENDLY

The mower is lifted and lowered again on the headland using a single-acting control unit. A special hydraulic compensating cylinder prevents the mower unit from freely swinging when it is lifted. Your sward and the cutter bar are therefore protected – for perfect forage quality and long machine life.

### At a glance:

- ▶ Premium mower with middle attachment
- ▶ Floating cut – TurboLift system
- ▶ No pivot movement on the headland
- ▶ Impact guard with pivoting gearbox
- ▶ Sliding guide both longitudinally and transversely – FELLA patent
- ▶ Upward folding full surround guard for good access and weight saving

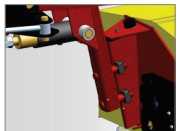

Sliding guide

### WE RECOMMEND\*:

- ▶ ComfortChange quick-change blade system to safely replace blades without losing too much time
- ▶ Right-hand swath disc for optimum swath formation

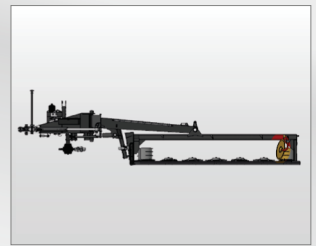
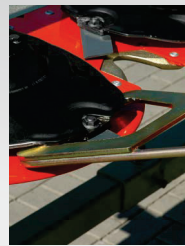

\*AS AN OPTION

## REAR-MOUNTED THREE-POINT ATTACHMENT, CENTRE HITCH ATTACHMENT

### SM 310 TL-KC SM 310 TL-RC

- ▶ Centrally hitched rear-mounted mower with conditioner
- ▶ High level of operational convenience



SM 310 TL-KC



Transport position



Sturdy frame



SM 310 TL-KC



TurboLift system



### PREMIUM REAR-MOUNTED MOWER WITH CONDITIONER

The SM 310 TL is a rear-mounted mower from the premium class which has a middle attachment at the centre of gravity and is available in various versions. You can choose between a tine-rotor conditioner and a roller conditioner. This means that the machines can be specially tailored to meet your needs and are well-equipped for an extremely wide range of mowing tasks.

### USER-FRIENDLY

The mower is lifted and lowered again on the headland using a single-acting control unit. A special hydraulic compensating cylinder prevents the mower unit from freely swinging when it is lifted. Your sward and the cutter bar are therefore protected.

### CONDITIONER – ACHIEVING QUALITY FORAGE MORE QUICKLY

If you use a conditioner, you achieve your quality forage more quickly because the moisture loss from your plants is accelerated. This gives you a decisive advantage, particularly in poor weather conditions – a faster way to produce your high-quality forage.



### At a glance:

- ▶ Centrally hitched mower
- ▶ Floating cut – TurboLift system
- ▶ Impact guard
- ▶ Sturdy frame
- ▶ Lift arm with low lying pivot point – low centre of gravity – beneficial for transport position
- ▶ Trailed cutter bar attachment – pulling is easier than pushing
- ▶ Compact parking position – thanks to the cutter bar which can be mechanically swung backwards
- ▶ Very easy attachment and removal of the conditioner thanks to modular system

### WE RECOMMEND\*:

- ▶ Additional skids for larger cutting heights and as wear protection for stony and sandy ground
- ▶ Stone guard for variant with RC, providing stone protection for the mower and conditioner

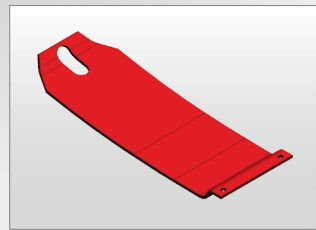

\*AS AN OPTION



# FIRST-RATE HARVEST!

Based on tradition, innovation and passion.

Mower combinations from FELLA



## REAR-MOUNTED MOWER COMBINATIONS

**SM 911 TL**  
**SM 911 TL-KC**  
**SM 911 TL-RC**  
**SM 911 TL-KCB**

- ▶ Perfect for use on large farms and for contractors
- ▶ Powerful alternatives to self-propelled machines
- ▶ Extremely low drag and cost-effective



SM 911 TL-KCB



Transport position

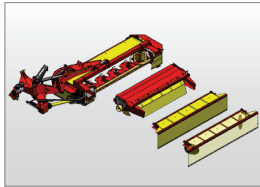

Easy attachment and removal of the conditioner thanks to modular system



Mowers in use



### CUTTING POWER WITHOUT COMPROMISE

This mower combination occupies the premium sector of mowing technology and has a working width of 8.30 m. The robust overall structure is uncompromisingly designed for maximum mowing performance, operational reliability and long service life. It combines the advantages of the FELLA compact angle cutter bar, the innovative TurboLift system and the patented SafetySwing impact guard in one machine, with which you can carry out even the most demanding of mowing work reliably and without stress. Ideally suited for a wide range of requirements, the SM 911 TL can be individually equipped to meet your needs. The mower combination can be equipped with a tine-rotor conditioner which can, in turn, be combined with a transverse conveyor belt. Whether you use the SM 911 TL on your own land or on more than one farm - you always have the comfortable feeling that you are well-equipped for any task and able to deliver extremely high-quality mowing work.

### COST-EFFECTIVENESS WHICH SPEAKS FOR ITSELF

Due to the particularly low power loss of the FELLA disc mowers, a tractor performance of approx. 200 hp is more than adequate for this mower combination - even when fully equipped with a conditioner and conveyor belt. In view of the continuously rising cost of fuel, one important aspect is to also be able to work cost-effectively in the future. The low maintenance requirement is also firmly on the "credit side" of your cost calculation.

### CONDITIONER - ACHIEVING QUALITY FORAGE MORE QUICKLY

The mower combination is also available with an optional tine-rotor conditioner (KC) or roller conditioner (RC). If you use a conditioner, the moisture loss from the forage is accelerated. This gives you a decisive time advantage, particularly in unpredictable weather conditions - a quicker and safer way to produce your quality forage.



### At a glance:

- ▶ Working width 8.30 metres
- ▶ Floating cut - TurboLift system
- ▶ Optional tine-rotor conditioner and roller conditioner
- ▶ Tine-rotor conditioner with transverse conveyor belt possible
- ▶ Integrated oil supply for conveyor belt variant - no oil cooler required
- ▶ Lifting arm with low lying pivot point - low centre of gravity
- ▶ Extremely simple to attach and remove the conditioner
- ▶ Trailed cutter bar attachment - pulling is easier than pushing
- ▶ The mower unit does not swing on the headland thanks to the hydraulic compensating cylinder
- ▶ SafetySwing impact guard



TurboLift system

### WE RECOMMEND\*:

- ▶ Electrohydraulic convenience control system for external load-sensing connections
- ▶ Mower disc with conveyor vane for optimum transport of the forage to the conditioner
- ▶ ComfortChange quick-change blade system to safely replace blades without losing too much time

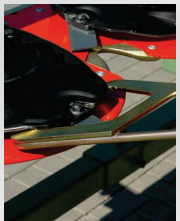

\*AS AN OPTION

## REAR-MOUNTED MOWER COMBINATIONS

### SM 991 TL SM 991 TL-KC SM 991 TL-KCB

- ▶ Perfect for use on large farms and for contractors
- ▶ Powerful alternatives to self-propelled machines
- ▶ Extremely low drag and cost-effective



SM 991 TL-KC



SM 991 TL-KC

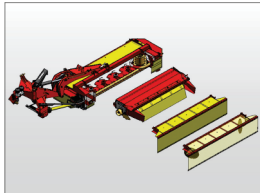

Easy attachment and removal of the conditioner due to modular system



SM 991 TL-KCB



### FELLA'S FLAGSHIP MOWER COMBINATIONS

With the SM 991 TL mower combination, FELLA is setting standards in output and cost-effectiveness. With a working width of 9.30 metres, you can easily handle any area of grassland – no matter how big. To be well-equipped for a wide range of demands, the SM 991 TL can be fitted with a tine-rotor conditioner which can, in turn, be combined with a transverse conveyor belt. Whether you use the SM 991 TL on your own land or on more than one farm – you always have the comfortable feeling that you are well-equipped for any task and able to deliver extremely high-quality mowing work.

### COST-EFFECTIVENESS WHICH SPEAKS FOR ITSELF

Due to the low powerloss of the FELLA disc mowers, a tractor output of approx. 230 hp is more than adequate for this mower combination – even when fully equipped with a conditioner and conveyor belt. In view of the continuously rising cost of fuel, one important aspect is to also be able to work cost-effectively in the future. The low maintenance requirement is also firmly on the "credit side" of your cost calculation.

### CONDITIONER – ACHIEVING QUALITY FORAGE MORE QUICKLY

The SM 991 TL mower combination is also available with a tine-rotor conditioner (KC). With a conditioner, you achieve your quality forage more quickly because the moisture loss from your plants is accelerated. This gives you a decisive time advantage, particularly in unpredictable weather conditions – a quicker and safer way to produce your quality forage.



### At a glance:

- ▶ Working width 9.30 metres
- ▶ Floating cut – TurboLift system
- ▶ Tine-rotor conditioner
- ▶ Tine-rotor conditioner with transverse conveyor belt possible
- ▶ Integrated oil supply for conveyor belt variant – no oil cooler required
- ▶ Extremely simple to attach and remove the conditioner
- ▶ Lifting arm with low lying pivot point – low centre of gravity
- ▶ Trailed cutter bar attachment – pulling is easier than pushing
- ▶ The mower unit does not swing on the headland thanks to the hydraulic compensating cylinder
- ▶ SafetySwing impact guard



TurboLift system

### WE RECOMMEND\*:

- ▶ Mower disc with conveyor vane for optimum transport of the forage to the conditioner
- ▶ ComfortChange quick-change blade system to safely replace blades without losing too much time

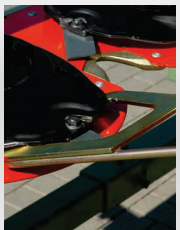

\* ALS OPTION

## REAR-MOUNTED MOWER COMBINATIONS WITH CONVEYOR BELT

### SM 8312 TL-RCB SM 9314 TL-KCB

- ▶ With ISOBUS control
- ▶ Perfect for use on large farms and for contractors
- ▶ Powerful alternatives to self-propelled machines
- ▶ Extremely low-drag and cost-effective



SM 8312 TL-RCB in use



Top conveyor belts



Use with forage rye



Transport position



ISOBUS terminal

drive  
GUARD

### MOWER COMBINATIONS FROM FELLA WITH ISOBUS CONTROL: MORE CONVENIENCE FOR HIGHER PERFORMANCE

The SM 8312 TL-RCB with a working width of 8.30 m and a roller conditioner, as well as the SM 9314 TL-KCB with a working width of 9.30 m and a tine-rotor conditioner combine the advantages of the tried-and-tested FELLA mower combinations with conveyor belts with the modern ISOBUS device control.

### ISOBUS - SIMPLE AND SAFE

With ISOBUS, you have a clear view of all important machine parameters on your tractor terminal at all times. You can easily control the individual functions at the touch of a button. All mower functions, such as single lift, conveyor belt operation and slope function, can be operated using a terminal, and can be programmed, if necessary, on the control lever or joystick. Switching from the working position to the transport position is completely automated.

Thanks to rotation speed monitoring using sensors, you can anticipate - from the driver's seat - a possible overloading of the drive train and thereby save your mower combination from adverse influences.

### WIDE BELT WITH INTEGRATED REMOVE HYDRAULIC LATERAL MOVEMENT

The two new mower combinations also have a wide conveyor belt (20 cm wider) with which even higher forage yields can be handled and still higher working speeds can be achieved.

Using the beMOVE hydraulic lateral movement and the conveyor belt's speed setting, you can always optimally adjust the mower's swath width to the working conditions and the collecting machines following behind. Even with heavy forage levels, swaths are optimally gathered together.

### EXTREMELY CONVENIENT TO OPERATE

By combining the front-mounted mower and the rear units, it is possible to fully automate the processes. Hour and hectare counters with integrated part-width shut-off can be used by agricultural contractors for billing purposes. Try out for yourself the sheer convenience and reliability provided by FELLA mower combinations with a widened conveyor belt and ISOBUS control.

### At a glance:

- ▶ Working widths of 8.30 m and 9.30 m
- ▶ Floating cut - TurboLift system
- ▶ SafetySwing impact guard
- ▶ Trailed cutter bar hitch attachment - pulling is easier than pushing
- ▶ Operation of all mower functions via ISOBUS control
- ▶ Rotation speed monitoring
- ▶ Wide conveyor belt with integrated beMOVE hydraulic lateral movement
- ▶ Central, single or partial swath deposit thanks to conveyor belts that can be raised individually
- ▶ ComfortChange quick-change blade system as standard, to safely replace blades without losing too much time
- ▶ Retrofit kit available for non-ISOBUS-compatible tractors



Hydraulic lateral movement of the conveyor belt

NEW!

ISOBUS

beMOVE hydraulic  
lateral movement

# FIRST-RATE HARVEST!

Based on tradition, innovation and passion.

Trailed mower from FELLA



## TRAILED - WITH TRANSPORT CHASSIS

**SM 313 TRANS**  
**SM 313 TRANS-KC**  
**SM 313 TRANS-RC**

- ▶ Versatile, trailed mower
- ▶ Centrally pivoted drawbar



SM 313 Trans-RC

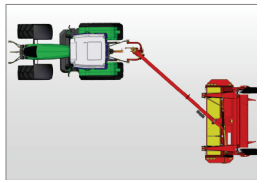

Can be pivoted to the left

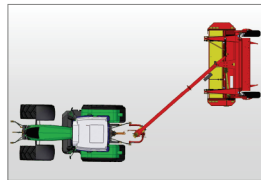

Can be pivoted to the right

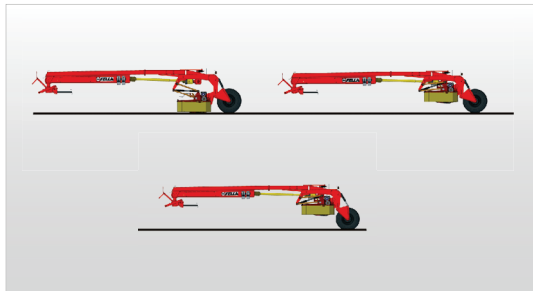

High lift travel provided by hydraulic cylinder



### EASE OF HANDLING, SUPERB AGILITY - SEE FOR YOURSELF

The SM 313 Trans is a trailed mower with a centrally linked drawbar. The machine is particularly characterised by its ease of handling and superb agility. The mower can be pivoted to the rear of the tractor both to the left and right. This gives you an enormous advantage, particularly with forage lying on the ground, on sloping terrain and for hillside lines. Due to the robust pivoting gearbox, an even transmission of power is ensured in every working situation, without bending the PTO-shaft - very little wear and a long service life. With a transport speed of up to 40 km/h\*, the transport is handled quickly and safely.

### EXCELLENT GROUND CONTOUR FOLLOWING

The cutter bar is mounted at the outermost points on the sturdy support frame. In conjunction with the parallel following of the mower to uneven ground, the mower is reliably prevented from digging into the soil - top-class quality forage without forage contamination. Due to the specially developed trailed suspension mounting of the cutter bar, the ground pressure is reduced to a minimum - whatever the pivot movement.

### USER-FRIENDLY

The working height can be infinitely and conveniently adjusted by a central crank. As a result, you can react to changing working conditions. In addition, you can perfectly adjust the ground contact pressure of the mower to your conditions. Due to the generous lifting height of the mower, turning manoeuvres on the headland can be carried out seamlessly without causing any damage to transverse swaths.

### CONDITIONER - ACHIEVING QUALITY FORAGE MORE QUICKLY

The SM 313 Trans is also available with an optional tine-rotor conditioner (KC) or roller conditioner (RC). With a conditioner, you achieve your quality forage more quickly because the moisture loss from your plants is accelerated. This gives you a decisive time advantage, particularly in unpredictable weather conditions - a quicker and safer way to produce your quality forage.

### At a glance:

- ▶ Centrally pivoted drawbar
- ▶ Roller conditioner or tine-rotor conditioner
- ▶ Power transmission through robust pivoting gearbox - low wear
- ▶ Excellent ground ground
- ▶ Infinitely adjustable cutting height
- ▶ High lift travel provided by integrated hydraulic cylinder



### WE RECOMMEND\*:

- ▶ Swath displacer, for moving the swath to the left and right in the combination operation when making a return pass
- ▶ Suppression hoop, for a perfect mowing result, even with heavy forage levels
- ▶ Large-size tyres 11.5/80-15.3, low ground pressure to protect delicate soil structure

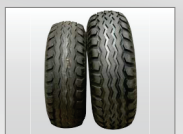

\* country-specific

\*AS AN OPTION

## TRAILED - WITH TRANSPORT CHASSIS

SM 3065 TRANS-KC  
SM 3065 TRANS-RC  
SM 3575 TRANS-KC  
SM 3575 TRANS-RC

- ▶ Versatile, trailed mower
- ▶ Centrally pivoted drawbar
- ▶ Extremely user-friendly



SM 3065 Trans-KC in use



Centrally pivoted drawbar



Transport position



High ground clearance thanks to high lifting height on the headland (up to 600 mm)



### TRAILED MOWER WITH CENTRALLY PIVOTED DRAWBAR

The SM 3065 Trans and SM 3575 Trans trailed mowers are available with a working width of 3.00 m and 3.50 m; both models are available with a tine-rotor conditioner or a roller conditioner. On the tine-rotor conditioner KC can adjust the intensity without the need for tools, which in turn ensures an extremely high level of flexibility in the most varied of weather conditions. The version with the RC roller conditioner is equipped with dual drive: The crop flow is therefore ensured, as is an excellent conditioning effect, even with large quantities of forage. The centrally pivoted drawbar can be swung to the left and the right behind the tractor: An enormous advantage on sloping terrains and for contour line work.

### HIGH LIFTING HEIGHT AND CONSIDERABLE FREEDOM OF MOVEMENT

The robust mower's stand-out point is the high lifting height on the headland of up to 600 mm: This provides an enormously high ground clearance when driving over swaths. The generous freedom of movement of the mower unit in the working position of up to 400 mm reliably prevents the mower unit from contacting the ground or digging into the sward on closely undulating ground. The mower unit is also suspended by adjustable spring packs and the contact pressure is adjusted to the working conditions.

### EXTREMELY USER-FRIENDLY

The driver has a high level of operational convenience: Thanks to the protective hood that can be folded up, the cutter bar is easily accessible. The infinitely variable cutting-height adjustment allows for quick and optimum adjustment of the cutting height for various different working conditions. Moreover, the robust pivoting gearbox provides optimum power transmission: The drive shaft is not bent, even when cornering tightly, and wear is kept to a minimum. In the tool box integrated in the drawbar, the required tool is very close to hand in the event of damage, and costly downtimes can thus be avoided.

Try out for yourself the new robust mowers that are appealingly designed.

### At a glance:

- ▶ Working widths: 3.00 m and 3.50 m
- ▶ Version available with a tine-rotor conditioner (KC) or a roller conditioner (RC)
- ▶ Centrally pivoted drawbar
- ▶ Generous freedom of movement of the mower unit in the working position
- ▶ High ground clearance thanks to a high lifting height on the headland (up to 600 mm)
- ▶ Extremely user-friendly



Integrated tool box in the drawbar



Version with RC



Version with KC

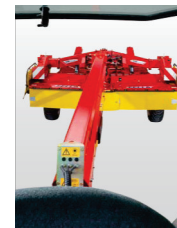

Clear view from the tractor



## TRAILED - WITH WHEEL SUPPORT

SM 311 TRANS  
SM 311 TRANS-KC  
SM 311 TRANS-RC  
SM 401 TRANS  
SM 401 TRANS-KC  
SM 401 TRANS-RC

▶ Trailed mower with wheel supports

▶ Edge mowing device

▶ Low stress on the three-point hydraulic system



SM 311 Trans-KC



Edge mowing (mower angled at 25°)



Narrow transport width

drive  
GUARD

### UNIQUE CONCEPT - ONLY FROM FELLA

With the models SM 311 Trans and SM 401 Trans, FELLA offer two trailed mowers with wheel supports. These machines are especially characterised by their narrow transport width but large working width. The weight of the machine is distributed evenly between the tractor and the running wheel. With the edge mowing device that is fitted as standard, the forage can be conveyed inwards and this prevents forage losses when mowing and the machine from slipping out of position into adjacent ditches. Due to the robust pivoting gearbox, the power is transmitted evenly in any working position - very little wear and a long service life. With a transport speed of up to 40 km/h\*, the machine can be driven quickly and safely to the next place of work.

### EXCELLENT GROUND CONTOUR FOLLOWING

The cutter bar is mounted at the outermost points on the sturdy support frame. In conjunction with the parallel following of the mower to uneven ground, the mower is reliably prevented from digging into the soil - for the best quality forage without contamination. Due to the specially developed trailed suspension mounting of the cutter bar, the ground pressure is reduced to a minimum - whatever the working angle.

### USER-FRIENDLY

The working height can be set centrally over an infinitely adjustable cutting height of 3.5-7.0 cm. As a result, you can adjust the machine to changing working conditions. In addition, you can precisely adjust the ground contact pressure of the mower to your conditions. Turning manoeuvres can be easily performed on the headland due to the generous lifting height of the mower unit. Changing from working position to transport position can be conveniently performed in seconds from the tractor seat.

### CONDITIONER - ACHIEVING QUALITY FORAGE MORE QUICKLY

The SM 311 Trans and SM 401 Trans are also available with an optional tine-rotor conditioner (KC) or roller conditioner (RC). With a conditioner, you achieve your quality forage more quickly because the moisture loss from your plants is accelerated. This gives you a decisive time advantage, particularly in unpredictable weather conditions - a quicker and safer way to produce your quality forage.

### At a glance:

- ▶ Trailed mower with wheel supports
- ▶ Up to 40 km/h\* transport road speed
- ▶ Infinitely adjustable cutting height
- ▶ Optional tine-rotor conditioner or roller conditioner
- ▶ Impact guard
- ▶ Higher lift travel (435 mm) provided by integrated hydraulic cylinder
- ▶ Narrow transport width

FELLA EXCLUSIVE  
Narrow on the road,  
wide out in the field

### WE RECOMMEND\*:

- ▶ Additional spring relief for low contact pressure for the mower
- ▶ Mower disc with conveyor vane for optimum transport of the forage to the conditioner
- ▶ ComfortChange quick-change blade system to safely replace blades without losing too much time

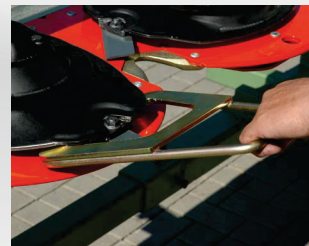
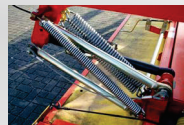

\*country-specific

\*AS AN OPTION



# FIRST-RATE HARVEST!

Based on tradition, innovation and passion.

Conditioner from FELLA



## CONDITIONERS



### WHY CHOOSE A CONDITIONER?

The mower-conditioner combination shortens the natural fermentation process of the mowed forage by hours. This gives you a decisive time advantage, particularly in unpredictable weather conditions – a quicker and safer way to produce your quality forage.

Through the use of a conditioner, the wax layer on the forage is rubbed off and a loose, lightly packed swath is deposited. Through intensive air circulation, moisture loss is accelerated and the dissipation of ground moisture which may be present is encouraged. This not only has a positive effect on your costs but also on the quality of your forage, because it reduces the disintegration losses and forage contamination to a minimum. FELLA offer two different conditioners for their mowers, a tine-rotor conditioner (KC) or a roller conditioner (RC).



### At a glance:

- ▶ Fermentation process is shortened
- ▶ Disintegration losses and forage contamination are reduced to a minimum
- ▶ Decisive advantage in adverse weather conditions
- ▶ Lower costs
- ▶ Improved forage quality

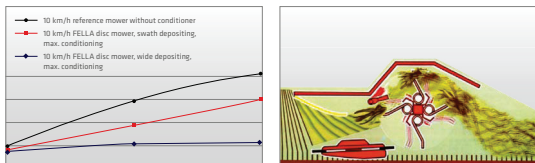

Graphical representation of the progression of drying: The reference swath (blue line) was mown with a disc mower without conditioner. The use of a conditioner considerably shortens the drying time of the mown forage (source: DLG Test report SM 400 Trans).

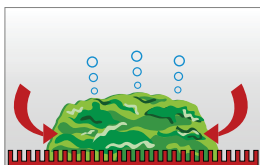

### TINE-ROTOR CONDITIONER

The spring tine rotor and the four-way adjustable conditioning comb produce a wavy forage structure permeable to air, the result of a number of interacting tools which open the top layer of the leaves, thus facilitating the drainage of water. The super C flexible tines are fitted as standard with loss protection and they are extremely resistant to foreign objects in the forage. Due to the preparation intensity, which can be easily adjusted using a counter-comb, a costly adjustment to the speed using a separate gear box is not necessary. This saves weight, reduces the maintenance effort and therefore saves you costs. The conditioner is driven using universal joints and is secured against overload using a shear bolt – a simple, but reliable drive concept.

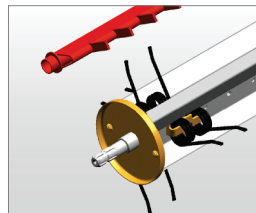

Tine-rotor conditioners



Roller conditioners

### ROLLER CONDITIONER

With two robust interlocking rubber profile elements for intensive but gentle preparation of legumes or other leafy forage. The hard stalks are squeezed through the rubber rolls and the delicate, nutrient-rich leaves are conserved. The contact pressure of the rubber profile elements can be adjusted to suit various forage and weather conditions. A spring-loaded foreign body protection is fitted as standard in the conditioner. The conditioner is driven using universal joints and is secured against overload using a shear bolt – a simple, but reliable drive concept. If they are worn or damaged, the rubber elements on the shaft can be individually replaced.

### At a glance:

- ▶ Simple drive concept with overload protection
- ▶ Super C flexible tines with loss protection
- ▶ Preparation intensity can be easily adjusted using a counter-comb (KC model)
- ▶ Roller conditioner for an intensive but less impactful preparation
- ▶ Rubber segments replaceable (RC model)
- ▶ Contact pressure can be variably adjusted (RC model)

## CONDITIONERS

### KC 275 D

- ▶ Ideal for alpine terrain
- ▶ Perfectly suitable for combination with front-mounted mower



### TINE-ROTOR CONDITIONER FOR RETROFITTING

### ROLLER CONDITIONER FOR RETROFITTING

#### TINE-ROTOR CONDITIONER FOR RETROFITTING

The FELLA tine-rotor conditioners with robust Super C tine-rotor conditioners can be retrofitted model-specifically.

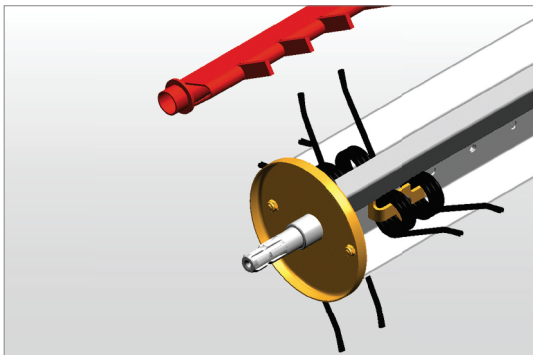

#### CONDITIONER FOR THE THREE-POINT ATTACHMENT

With the combined use of a front-mounted mower and a KC 275 D rear-mounted conditioner, you can achieve an unprecedented level of efficiency for the forage harvest in alpine areas. The optimum weight distribution leads to an excellent tracking stability, even on difficult sections. The forage is optimally prepared and loosely deposited by the conditioner - an important requirement for perfect quality forage.



KC 275 D

#### ROLLER CONDITIONER FOR RETROFITTING

The FELLA roller conditioners with rubber profile elements which reach far into each other can be retrofitted model-specifically.







Best harvest – based on tradition, innovation and passion.

## FELLA FOR YOU

"We can't change the weather, but we have the machines that will allow you to make the most of any conditions."

Your FELLA team



### PHILOSOPHY

For FELLA, close contact with our customers is very important. The experiences of farmers and agricultural contractors who use FELLA products around the world is collected and is purposefully incorporated into the design of our products.

### PATENTS

It is FELLA's objective to create ingenious and sustainable solutions for our products. This has already been well documented through numerous FELLA patents.

### SERVICE

"Out of sight, out of mind." But not at FELLA!

Together with our dealers, we are always there and ready to provide reliable support to our partners, both at home and abroad – as we have been doing for almost 100 years. In conjunction with our well organised spare parts stores, regular further technical training for our dealers ensures that FELLA machines can be used, maintained and repaired to a professional standard. This comprehensive service ensures minimum downtime for your FELLA machines and makes a significant contribution to high-yield and stress-free forage harvesting.



- ▶ Exceptionally wide range of mowers, hay tedders and rakes
- ▶ Innovation and progress: continuous further development for a first-rate harvest
- ▶ Minimum downtime, maximum machine availability thanks to professional dealers and a well-organised spare parts supply
- ▶ Long service life machines "Made in Germany"

**FELLA-Werke GmbH**

Fellastraße 1-3  
D-90537 Feucht

☎ +49 9128 73-0

☎ +49 9128 73-117

fella-vertrieb@AGCOcorp.com

[www.fella.eu](http://www.fella.eu)

**Your FELLA quality partner**