



**BERLI**<sup>®</sup>  
MACCHINE AGRICOLE

**TA/MI**  
**TA/M**  
**TA**  
**TA/S**  
**TA/P**  
**TA/PS**



**Trinciargini per trattori da 50 a 200 HP**



**In-line and offset mulchers for tractors from 50 to 200 HP**



**Böschungsmulcher für Traktoren von 50 bis 200 PS**



**Broyeurs multifonctions pour tracteurs de 50 a 200 CV**



**Trituradoras de laderas para tractores de 50 a 200 CV**





- Valvola di sicurezza.
- Safety valve.
- Sicherheitsventil.
- Soupape de sûreté.
- Válvula de seguridad.

- Valvola di blocco.
- Block valve.
- Sperrventilblock.
- Soupape de bloc.
- Válvula de bloque.

- Attacco terzo punto con sistema flottante e fermo di sicurezza.
- 3 point linkage with floating system and safety lock.
- Dreipunktbock mit Schwimmstellung-System und Sperrbolzen.
- Attelage à 3 points avec système flottante et arrêt de sécurité.
- Enganche a los tres puntos con sistema flotante y bloqueo de seguridad.

**STRENX®**  
PERFORMANCE STEEL

- Tenditore automatico delle cinghie.
- Full automatic belts adjuster.
- Automatische Riemenspannung.
- Tendeur automatique des courroies.
- Tensor automático de las correas.

 Trinciatrice compatta multiuso con attacco ai tre punti Cat. II (**Cat. I a richiesta**), da applicare a trattori con potenza compresa tra 50 e 90 HP. Adatta a lavorare sia posteriormente che lateralmente al trattore. E' consigliata per erba, residui vegetali, cespugli e sarmenti di  $\varnothing$  4-5 cm.. Ideale per la pulizia di parchi, aree verdi, giardini, bordi di strade, su fossati, argini e terreni inclinati in genere.









 Broyeur d'accotement multifonctions avec attelage à 3 points Cat. II (**Cat. I sur demande**) pour broyer l'herbe, les déchets végétaux, les buissons et les sarments allant jusqu'à  $\varnothing$  4-5 cm; indiqué pour tracteurs de 50 à 90 CV. Il est idéal pour le nettoyage des espaces verts, des jardins, des rebords de route, des fossés, des digues et des terrains inclinés.

 Offset/in-line mulcher for grass, residue of vegetables, bushes and pruning up to  $\varnothing$  4-5 cm., with 3-point linkage Cat. II (**Cat. I on request**). Suited for tractors from 50 to 90 HP and ideal for clearing green areas, gardens, slopes, ditches, banks of watercourses, road side banks.

 Trituradora compacta multiuso con enganche a los 3 puntos Cat. II (**Cat. I bajo petición**) de aplicar a tractores con potencia comprendida entre 50 y 90 HP. Apta para trabajar tanto posteriormente como lateralmente al tractor. Es recomendada para hierba, residuos vegetales, arbustos y sarmientos de  $\varnothing$  4-5 cm. Ideal para la limpieza de parques, áreas verdes, jardines, bordes de carreteras, zanjas, riberas y terrenos inclinados en general.

 Universalgerät für Heckanbau, für seitliches Mulchen oder hinter dem Schlepper mit Dreipunktbock Kat.II (**Kat. I auf Anfrage**); für Gras, Vegetation, Reisig und Äste bis  $\varnothing$  4-5 cm, für Randstreifen, Wassergräben und Böschungen, für Traktoren von 50 bis 90 PS.

*Il trattore deve essere dotato di almeno n.2 prese d'olio a doppio effetto / The tractor has to be equipped with n. 2 double effect oil plugs / Der Traktor muss mit 2 doppelwirkenden Hydraulikanschlüssen ausgestattet sein / Le tracteur doit être équipé avec au moins 2 prises d'huile à double effet / El tractor deberá estar equipado con al menos dos enchufes hidráulicos con válvula de doble efecto.*

Mod.									
	cm	Min	Max	n°	n°	n°	PTO	min	max
<b>TA/MI 145</b>	140	50	90	14	42	3	540	570	680
<b>TA/MI 160</b>	155	50	90	14	42	3	540	600	710
<b>TA/MI 180</b>	175	50	90	16	48	3	540	635	745
<b>TA/MI 200</b>	195	50	90	18	54	3	540	670	780



- Sistema flottante con limitatore.
- Floating device, with limiter.
- Schwimmstellung-System mit Hubbegrenzer.
- Système flottante avec limiteur.
- Sistema de enganche flotante con limitador.



- Rullo livellatore posteriore autopulente, regolabile in altezza.
- Height adjustable self-cleaning levelling roller.
- Höhenverstellbare und selbstreinigende Stützwalze.
- Rouleau palpeur autonettoyant, réglable en hauteur.
- Rodillo trasero autolimpiable y regulable en altura.

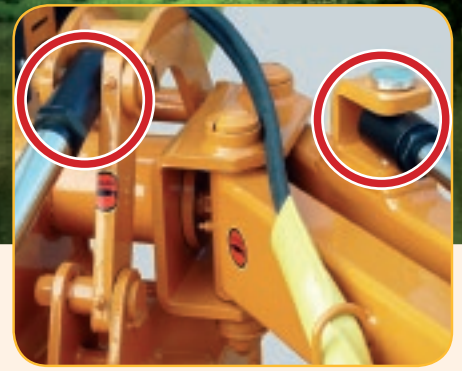

- Martinetti regolabili.
- Adjustable cylinders.
- Einstellbare hydr. Zylinder.
- Vérins réglables.
- Cilindros hidráulicos con extensión ajustable.



- Fiancata destra arrotondata.
- Chamfered profile on the right-end chassis corner.
- Seitlich Abschrägung auf Mulcherrahmen.
- Coin côté droite arrondi.
- Ángulo lateral derecho redondeado.



- Albero cardanico.
- PTO drive shaft.
- Gelenkwelle.
- Arbre cardan.
- Árbol de transmisión.

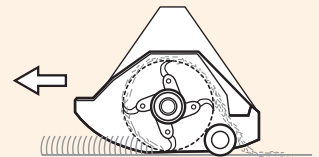

## OPTIONALS



- Distributore a doppio effetto con leve e cavi flessibili.
- Double effect distributor with levers and with wire-cables.
- Doppelwirkendes Steuerventil mit Hebeln und Bowdenzügen.
- Distributeur hydraulique double effet à leviers avec téléflexibles en cabine.
- Distribuidor de doble efecto con levas y cables flexibles.



- Kit segnaletica stradale con luci.
- Set road-warning panels with lights.
- Satz Warntafel mit Beleuchtung.
- Kit de signalisation avec système d'éclairage.
- Kit de señalización de carretera con luces.



- Sistema antishock BERTI\*.
- Exclusive BERTI Anti-Shock Device\*.
- Anti-Schock System BERTI\*.
- Système antichoc exclusif BERTI\*.
- Dispositivo antichoque exclusivo de Berti\*.



- Slitte d'appoggio antiusura.
- Skids of anti-wearing steel.
- Satz Kufen mit Anti-Verschleißmaterial.
- Jeu patins anti-usure.
- Patines de acero reforzado anti-desgaste.



- Albero cardanico doppio omocinetico.
- Double Wide-Angle drive shaft.
- Doppel-Weitwinkel Gelenkwelle.
- Arbre cardan double homocinétique.
- Árbol de transmisión doble homocinético.

# TA/M



- Valvola di sicurezza.
- Safety valve.
- Sicherheitsventil.
- Soupape de sûreté.
- Válvula de seguridad.

- Valvola di blocco.
- Block valve.
- Sperrventilblock.
- Soupape de bloc.
- Válvula de bloque.

- Attacco terzo punto con sistema flottante e fermo di sicurezza.
- 3 point linkage with floating system and safety lock.
- Dreipunktbock mit Schwimmstellung-System und Sperrbolzen.
- Attelage à 3 points avec système flottante et arrêt de sécurité.
- Enganche a los tres puntos con sistema flotante y bloqueo de seguridad.

- Tenditore automatico delle cinghie.
- Full automatic belts adjuster.
- Automatische Riemenspannung.
- Tendeur automatique des courroies.
- Tensor automático de las correas.

**STRENX®**  
PERFORMANCE STEEL

 Trinciatrice compatta multiuso con attacco ai tre punti Cat. II (**Cat. I a richiesta**), da applicare a trattori con potenza compresa tra 50 e 90 HP. Adatta a lavorare sia posteriormente che lateralmente al trattore. E' consigliata per erba, residui vegetali, cespugli e sarmenti di Ø 4-5 cm.. Ideale per la pulizia di parchi, aree verdi, giardini, bordi di strade, su fossati, argini e terreni inclinati in genere.







 Broyeur d'accotement multifonctions avec attelage à 3 points Cat. II (**Cat. I sur demande**) pour broyer l'herbe, les déchets végétaux, les buissons et les sarments allant jusqu'à Ø 4-5 cm; indiqué pour tracteurs de 50 à 90 CV. Il est idéal pour le nettoyage des espaces verts, des jardins, des rebords de route, des fossés, des digues et des terrains inclinés.

 Offset/in-line mulcher for grass, residue of vegetables, bushes and pruning up to Ø 4-5 cm., with 3-point linkage Cat. II (**Cat. I on request**). Suited for tractors from 50 to 90 HP and ideal for clearing green areas, gardens, slopes, ditches, banks of watercourses, road side banks.

 Trituradora compacta multiuso con enganche a los 3 puntos Cat. II (**Cat. I bajo petición**) de aplicar a tractores con potencia comprendida entre 50 y 90 HP. Apta para trabajar tanto posteriormente como lateralmente al tractor. Es recomendada para hierba, residuos vegetales, arbustos y sarmientos de Ø 4-5 cm. Ideal para la limpieza de parques, áreas verdes, jardines, bordes de carreteras, zanjas, riberas y terrenos inclinados en general.

 Universalgerät für Heckanbau, für seitliches Mulchen oder hinter dem Schlepper mit Dreipunktbock Kat.II (**Kat. I auf Anfrage**); für Gras, Vegetation, Reisig und Äste bis Ø 4-5 cm, für Randstreifen, Wassergräben und Böschungen, für Traktoren von 50 bis 90 PS.

*Il trattore deve essere dotato di almeno n.2 prese d'olio a doppio effetto / The tractor has to be equipped with n. 2 double effect oil plugs / Der Traktor muss mit 2 doppelwirkenden Hydraulikanschlüssen ausgestattet sein / Le tracteur doit être équipé avec au moins 2 prises d'huile à double effet / El tractor deberá estar equipado con al menos dos enchufes hidráulicos con válvula de doble efecto.*

Mod.								
	cm	Min	Max	n°	n°	n°	min	max
<b>TA/M 145</b>	140	50	90	14	42	3	540	700
<b>TA/M 160</b>	155	50	90	14	42	3	540	730
<b>TA/M 180</b>	175	50	90	16	48	3	540	765
<b>TA/M 200</b>	195	50	90	18	54	3	540	800





- Sistema flottante con limitatore.
- Floating device, with limiter.
- Schwimmstellung-System mit Hubbegrenzer.
- Système flottante avec limiteur.
- Sistema de enganche flotante con limitador.



- Rullo livellatore posteriore autopulente, regolabile in altezza.
- Height adjustable self-cleaning levelling roller.
- Höhenverstellbare und selbstreinigende Stützwalze.
- Rouleau palpeur autonettoyant, réglable en hauteur.
- Rodillo trasero autolimpiable y regulable en altura.

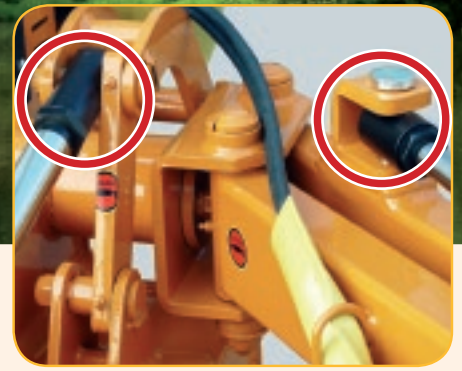

- Martinetti regolabili.
- Adjustable cylinders.
- Einstellbare hydr. Zylinder.
- Vérins réglables.
- Cilindros hidráulicos con extensión ajustable.



- Fiancata destra arrotondata.
- Chamfered profile on the right-end chassis corner.
- Seitlich Abschrägung auf Mulcherrahmen.
- Coin côté droite arrondi.
- Ángulo lateral derecho redondeado.



- Albero cardanico.
- PTO drive shaft.
- Gelenkwelle.
- Arbre cardan.
- Árbol de transmisión.

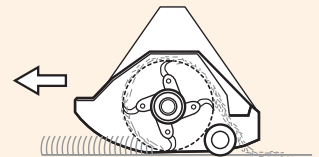

## OPTIONALS



- Distributore a doppio effetto con leve e cavi flessibili.
- Double effect distributor with levers and with wire-cables.
- Doppelwirkendes Steuerventil mit Hebeln und Bowdenzügen.
- Distributeur hydraulique double effet à leviers avec téléflexibles en cabine.
- Distribuidor de doble efecto con levas y cables flexibles.



- Kit segnaletica stradale con luci.
- Set road-warning panels with lights.
- Satz Warntafel mit Beleuchtung.
- Kit de signalisation avec système d'éclairage.
- Kit de señalización de carretera con luces.



- Sistema antishock BERTI\*.
- Exclusive BERTI Anti-Shock Device\*.
- Anti-Schock System BERTI\*.
- Système antichoc exclusif BERTI\*.
- Dispositivo antichoque exclusivo de Berti\*.



- Slitte d'appoggio antiusura.
- Skids of anti-wearing steel.
- Satz Kufen mit Anti-Verschleißmaterial.
- Jeu patins anti-usure.
- Patines de acero reforzado anti-desgaste.



- Albero cardanico doppio omocinetico.
- Double Wide-Angle drive shaft.
- Doppel-Weitwinkel Gelenkwelle.
- Arbre cardan double homocinétique.
- Árbol de transmisión doble homocinético.

# TA



**STRENX®**  
PERFORMANCE STEEL



- Valvola di blocco.
- Block valve.
- Sperrventilblock.
- Soupape de bloc.
- Válvula de bloque.



- Attacco terzo punto con sistema flottante e fermo di sicurezza.
- 3 point linkage with floating system and safety lock.
- Dreipunktbock mit Schwimmstellung-System und Sperrbolzen.
- Attelage à 3 points avec système flottante et arrêt de sécurité.
- Enganche a los tres puntos con sistema flotante y bloqueo de seguridad.

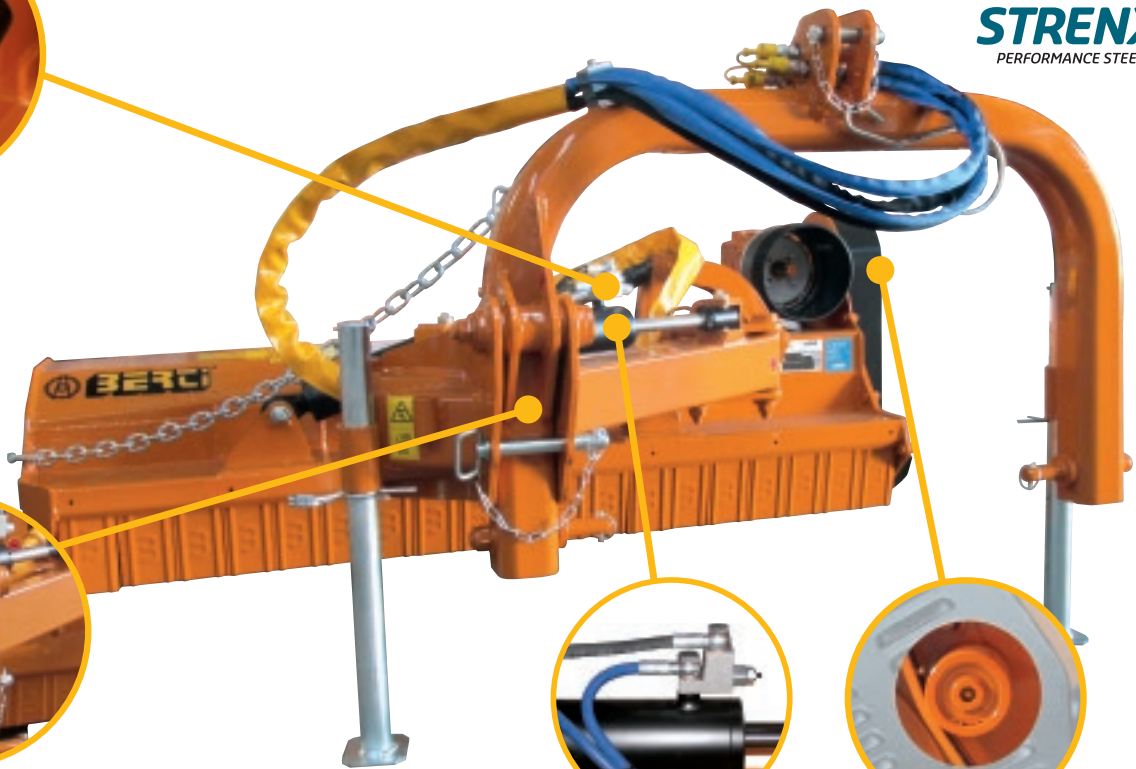

- Valvola di sicurezza.
- Safety valve.
- Sicherheitsventil.
- Soupape de sûreté.
- Válvula de seguridad.

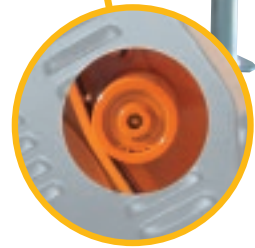

- Tenditore automatico delle cinghie.
- Full automatic belts adjuster.
- Automatische Riemenspannung.
- Tendeur automatique des courroies.
- Tensor automático de las correas.



Trinciatrice compatta multiuso, da applicare a trattori con potenza compresa tra 60 e 110 HP. Adatta a lavorare sia posteriormente che lateralmente al trattore. E' consigliata per erba, residui vegetali, cespugli e sarmenti di  $\varnothing$  7-8 cm.. Ideale per la pulizia di parchi, aree verdi, giardini, bordi di strade, su fossati, argini e terreni inclinati in genere.



Broyeur d'accotement multifonctions pour broyer l'herbe, les déchets végétaux, les buissons et les sarments allant jusqu'à  $\varnothing$  7-8 cm; indiqué pour tracteurs de 60 à 110 CV. Il est idéal pour le nettoyage des espaces verts, des jardins, des rebords de route, des fossés, des digues et des terrains inclinés.



Offset/in-line mulcher for grass, residue of vegetables, bushes and pruning up to  $\varnothing$  7-8 cm., suited for tractors from 60 to 110 HP. Ideal for clearing green areas, gardens, slopes, ditches, banks of water-courses, road side banks.



Trituradora compacta multiuso, de aplicar a tractores con potencia comprendida entre 60 y 110 HP. Apta para trabajar tanto posteriormente como lateralmente al tractor. Es recomendada para hierba, residuos vegetales, arbustos y sarmientos de  $\varnothing$  7-8 cm. Ideal para la limpieza de parques, áreas verdes, jardines, bordes de carreteras, zanjas, riberas y terrenos inclinados en general.



Universalgerät für Heckenbau, für seitliches Mulchen oder hinter dem Schlepper für Gras, Vegetation, Reisig und Äste bis  $\varnothing$  7-8 cm für Randstreifen, für Wassergräben und Böschungen, für Traktoren von 60 bis 110 PS.

Il trattore deve essere dotato di almeno n.2 prese d'olio a doppio effetto / The tractor has to be equipped with n. 2 double effect oil plugs / Der Traktor muss mit 2 doppelwirkenden Hydraulikanschlüssen ausgestattet sein / Le tracteur doit être équipé avec au moins 2 prises d'huile à double effet / El tractor deberá estar equipado con al menos dos enchufes hidráulicos con válvula de doble efecto.

Mod.									
	cm	Min	Max					HP	n°
<b>TA 160</b>	151	60	110	14	42	4	540	780	885
<b>TA 180</b>	171	60	110	16	48	4	540	815	925
<b>TA 200</b>	191	60	110	18	54	4	540	855	975
<b>TA 220</b>	211	60	110	20	60	4	540	900	1030
<b>TA 250</b>	243	60	110	22	66	4	540	980	1110





- Sistema flottante con limitatore.
- Floating device, with limiter.
- Schwimmstellung-System mit Hubbegrenzer.
- Système flottante avec limiteur.
- Sistema de enganche flotante con limitador.



- Rullo autopulente regolabile in altezza.
- Self-cleaning and height adjustable roller.
- Selbstreinigender und höhenverstellbarer Stützwalze.
- Rouleau auto-nettoyant réglable en hauteur.
- Rodillo auto-limpiable regulable en altura.

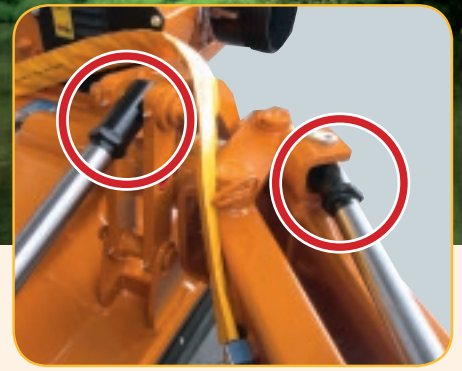

- Martinetti regolabili.
- Adjustable cylinders.
- Einstellbare hydr. Zylindern.
- Vérins réglables.
- Cilindros hidráulicos con extensión ajustable.



- Fiancata destra arrotondata.
- Chamfered profile on the right-end chassis corner.
- Seitlich Abschrägung auf Mulcherrahmen.
- Coin côté droite arrondi.
- Ángulo lateral derecho redondeado.



- Albero cardanico.
- PTO drive shaft.
- Gelenkwelle.
- Arbre cardan.
- Árbol de transmisión.

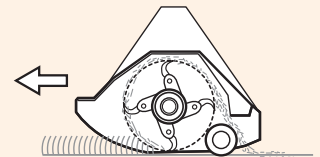

## OPTIONALS

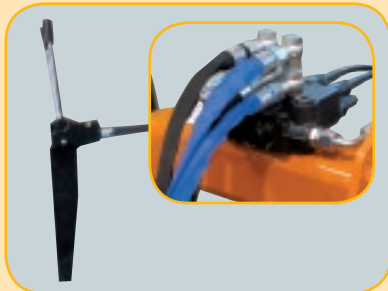

- Distributore a doppio effetto con leve e cavi flessibili.
- Double effect distributor with levers and with wire-cables.
- Doppelwirkendes Steuerventil mit Hebeln und Bowdenzügen.
- Distributeur hydraulique double effet à leviers avec téléflexibles en cabine.
- Distribuidor de doble efecto con levas y cables flexibles.

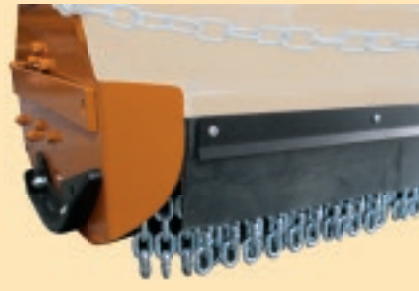

- Protezioni frontali in catena e gomma.
- Front chains protectors & rubber.
- Frontschutze mit Ketten + Gummi.
- Protections frontales par chaînes et caoutchouc.
- Protecciones frontales en cadenas con goma.



- Kit segnaletica stradale con luci.
- Set road-warning panels with lights.
- Satz Warntafel mit Beleuchtung.
- Kit de signalisation avec système d'éclairage.
- Kit de señalización de carretera con luces.



- Sistema antishock BERTI\*.
- Exclusive BERTI Anti-Shock Device\*.
- Anti-Schock System BERTI\*.
- Système antichoc exclusif BERTI\*.
- Dispositivo antichoque exclusivo de Berti\*.



- Slitte d'appoggio antiusura.
- Skids of anti-wearing steel.
- Satz Kufen mit Anti-Verschleißmaterial.
- Jeu patins anti-usure.
- Patines de acero reforzado anti-desgaste.



- Albero cardanico doppio omocinetico.
- Double Wide-Angle drive shaft.
- Doppel-Weitwinkel Gelenkwelle.
- Arbre cardan double homocinétique.
- Árbol de transmisión doble homocinético.

# TA/S



**STRENX®**  
PERFORMANCE STEEL



- Valvola di sicurezza.
- Safety valve.
- Sicherheitsventil.
- Soupape de sûreté.
- Válvula de seguridad.

- Valvola di blocco.
- Block valve.
- Sperrventilblock.
- Soupape de bloc.
- Válvula de bloque.



- Attacco terzo punto con sistema flottante e fermo di sicurezza.
- 3 point linkage with floating system and safety lock.
- Dreipunktbock mit Schwimmstellung-System und Sperrbolzen.
- Attelage à 3 points avec système flottante et arrêt de sécurité.
- Enganche a los tres puntos con sistema flotante y bloqueo de seguridad.



- Tenditore automatico delle cinghie.
- Full automatic belts adjuster.
- Automatische Riemenspannung.
- Tendeur automatique des courroies.
- Tensor automático de las correas.

Trinciatrice compatta multiuso, da applicare a trattori con potenza compresa tra 60 e 110 HP. Adatta a lavorare sia posteriormente che lateralmente al trattore. E' consigliata per erba, residui vegetali, ceppugli e sarmenti di Ø 7-8 cm.. Ideale per la pulizia di parchi, aree verdi, giardini, bordi di strade, su fossati, argini e terreni inclinati in genere.

Broyeur d'accotement multifonctions pour broyer l'herbe, les déchets végétaux, les buissons et les tiges allant jusqu'à Ø 7-8 cm; adapté pour tracteurs de 60 à 110 CV. Il est idéal pour le nettoyage des espaces verts, des jardins, des rebords de route, des fossés, des digues et des terrains inclinés.

Offset/in-line mulcher for grass, residue of vegetables, bushes and pruning up to Ø 7-8 cm., suited for tractors from 60 to 110 HP. Ideal for clearing green areas, gardens, slopes, ditches, banks of water-courses, road side banks.

Trituradora compacta multiuso, de aplicar a tractores con potencia comprendida entre 60 y 110 HP. Apta para trabajar tanto posteriormente como lateralmente al tractor. Es recomendada para hierba, residuos vegetales, arbustos y sarmientos de Ø 7-8 cm. Ideal para la limpieza de parques, áreas verdes, jardines, bordes de carreteras, zanjas, riberas y terrenos inclinados en general.

Universalgerät für Heckanbau, für seitliches Mulcher oder hinter dem Schlepper für Gras, Vegetation, Reisig und Äste bis Ø 7-8 cm. für Randstreifen, für Wassergräben und für Böschungen, für Traktoren von 60 bis 110 PS.

*Il trattore deve essere dotato di almeno n.2 prese d'olio a doppio effetto / The tractor has to be equipped with n. 2 double effect oil plugs / Der Traktor muss mit 2 doppelwirkenden Hydraulikanschlüssen ausgestattet sein / Le tracteur doit être équipé avec au moins 2 prises d'huile à double effet / El tractor deberá estar equipado con al menos dos enchufes hidráulicos con válvula de doble efecto.*

Mod.									
	cm	Min	Max	n°	n°	n°	PTO	min	max
<b>TA/S 160</b>	151	60	110	14	42	4	540	810	915
<b>TA/S 180</b>	171	60	110	16	48	4	540	845	955
<b>TA/S 200</b>	191	60	110	18	54	4	540	885	1005
<b>TA/S 220</b>	211	60	110	20	60	4	540	925	1055





- Sistema flottante con limitatore.
- Floating device, with limiter.
- Schwimmstellung-System mit Hubbegrenzer.
- Système flottante avec limiteur.
- Sistema de enganche flotante con limitador.



- Rullo autopulente regolabile in altezza.
- Self-cleaning and height adjustable roller.
- Selbstreinigender und höhenverstellbarer Stützwalze.
- Rouleau auto-nettoyant réglable en hauteur.
- Rodillo auto-limpiable regulable en altura.

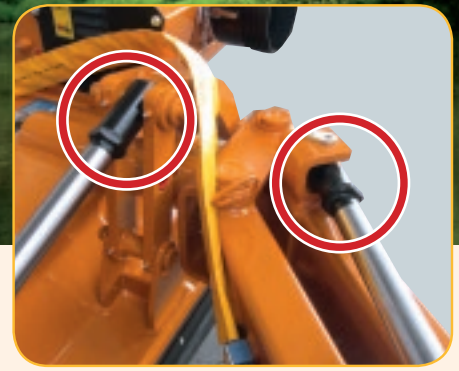

- Martinetti regolabili.
- Adjustable cylinders.
- Einstellbare hydr. Zylindern.
- Vérins réglables.
- Cilindros hidráulicos con extensión ajustable.



- Fiancata destra arrotondata.
- Chamfered profile on the right-end chassis corner.
- Seitlich Abschrägung auf Mulcherrahmen.
- Coin côté droite arrondi.
- Ángulo lateral derecho redondeado.



- Albero cardanico.
- PTO drive shaft.
- Gelenkwelle.
- Arbre cardan.
- Árbol de transmisión.

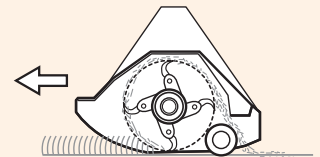

## OPTIONALS

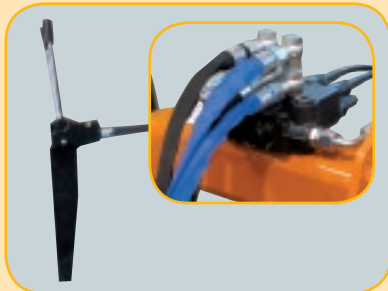

- Distributore a doppio effetto con leve e cavi flessibili.
- Double effect distributor with levers and with wire-cables.
- Doppelwirkendes Steuerventil mit Hebeln und Bowdenzügen.
- Distributeur hydraulique double effet à leviers avec téléflexibles en cabine.
- Distribuidor de doble efecto con levas y cables flexibles.



- Protezioni frontali in catena e gomma.
- Front chains protectors & rubber.
- Frontschutze mit Ketten + Gummi.
- Protections frontales par chaînes et caoutchouc.
- Protecciones frontales en cadenas con goma.



- Kit segnaletica stradale con luci.
- Set road-warning panels with lights.
- Satz Warntafel mit Beleuchtung.
- Kit de signalisation avec système d'éclairage.
- Kit de señalización de carretera con luces.



- Sistema antishock BERTI\*.
- Exclusive BERTI Anti-Shock Device\*.
- Anti-Schock System BERTI\*.
- Système antichoc exclusif BERTI\*.
- Dispositivo antichoque exclusivo de Berti\*.



- Slitte d'appoggio antiusura.
- Skids of anti-wearing steel.
- Satz Kufen mit Anti-Verschleißmaterial.
- Jeu patins anti-usure.
- Patines de acero reforzado anti-desgaste.



- Albero cardanico doppio omocinetico.
- Double Wide-Angle drive shaft.
- Doppel-Weitwinkel Gelenkwelle.
- Arbre cardan double homocinétique.
- Árbol de transmisión doble homocinético.

# TA/P



- Valvola di blocco.
- Block valve.
- Sperrventilblock.
- Soupape de bloc.
- Válvula de bloque.



**STRENX®**  
PERFORMANCE STEEL



- Attacco terzo punto con sistema flottante e fermo di sicurezza.
- 3 point linkage with floating system and safety lock.
- Dreipunktbock mit Schwimmstellung-System und Sperrbolzen.
- Attelage à 3 points avec système flottante et arrêt de sécurité.
- Enganche a los tres puntos con sistema flotante y bloqueo de seguridad.



- Valvola di sicurezza.
- Safety valve.
- Sicherheitsventil.
- Soupape de sûreté.
- Válvula de seguridad.

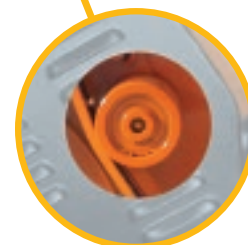

- Tenditore automatico delle cinghie.
- Full automatic belts adjuster.
- Automatische Riemenspannung.
- Tendeur automatique des courroies.
- Tensor automático de las correas.



Trinciatrice professionale multiuso da applicare a trattori con potenza compresa tra 80 e 200 HP. Adatta a lavorare sia posteriormente che lateralmente al trattore. E' consigliata per erba, residui vegetali, cespugli e sarmenti fino a  $\varnothing$  10 cm., Ideale per la pulizia di parchi, aree verdi, giardini, bordi di strade, su fossati, argini e terreni inclinati in genere



Broyeur professionnel renforcé multifonctions pour broyer l'herbe, les déchets végétaux, les buissons et les sarments allant de  $\varnothing$  10 cm; adapté pour tracteurs de 80 à 200 CV. Machine idéale pour les personnes qui travaillent pour le compte de tiers et qui doivent nettoyer le rebord des routes, fossés, digues et espaces verts publiques.



Heavy-duty offset / in-line mulcher for grass, residue of vegetables, bushes and pruning up to  $\varnothing$  10 cm., suited for tractors from 80 to 200 HP. Ideal machine for contractors who need to clear slopes, ditches, banks of watercourses, road side banks and public green areas in general.



Trituradora profesional multiuso, de aplicar a tractores con potencia comprendida entre 80 y 200 HP. Apta para trabajar tanto posteriormente como lateralmente al tractor. Es recomendada para hierba, residuos vegetales, arbustos y sarmientos de  $\varnothing$  10 cm. Ideal para la limpieza de parques, áreas verdes, jardines, bordes de carreteras, zanjas, riberas y terrenos inclinados en general.



Universalgerät für Heckanbau, für seitliches Mulchen oder hinter dem Schlepper für Gras, Vegetation, Reisig und Äste mit  $\varnothing$  10 cm. für Randstreifen, für Wassergräben und für Böschungen für Traktoren von 80 bis 200 PS.

*Il trattore deve essere dotato di almeno n.2 prese d'olio a doppio effetto / The tractor has to be equipped with n. 2 double effect oil plugs / Der Traktor muss mit 2 doppelwirkenden Hydraulikanschlüssen ausgestattet sein / Le tracteur doit être équipé avec au moins 2 prises d'huile à double effet / El tractor deberá estar equipado con al menos dos enchufes hidráulicos con válvula de doble efecto.*

Mod.									
	cm	Min	Max	n°	n°	n°	PTO	min	max
<b>TA/P 160</b>	153	80	200	14	42	5	540	920	1075
<b>TA/P 180</b>	173	85	200	16	48	5	540	970	1125
<b>TA/P 200</b>	193	85	200	18	54	5	540	1020	1175
<b>TA/P 220</b>	213	85	200	20	60	5	540	1070	1225
<b>TA/P 250</b>	243	100	200	22	66	5	540	1135	1290





- Sistema flottante con limitatore.
- Floating device, with limiter.
- Schwimmstellung-System mit Hubbegrenzer.
- Système flottante avec limiteur.
- Sistema de enganche flotante con limitador.



- Rullo autopulente regolabile in altezza.
- Self-cleaning and height adjustable roller.
- Selbstreinigender und höhenverstellbarer Stützwalze.
- Rouleau auto-nettoyant réglable en hauteur.
- Rodillo auto-limpiable regulable en altura.

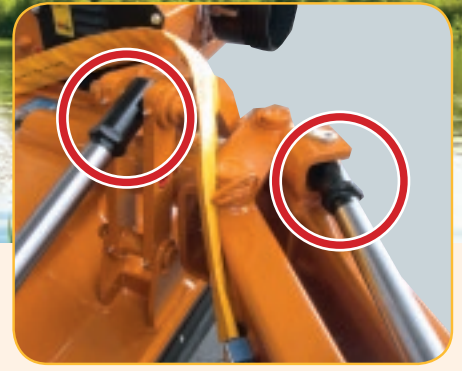

- Martinetti regolabili.
- Adjustable cylinders.
- Einstellbare hydr. Zylindern.
- Vérins réglables.
- Cilindros hidráulicos con extensión ajustable.



- Fiancata destra arrotondata.
- Chamfered profile on the right-end chassis corner.
- Seitlich Abschrägung auf Mulcherrahmen.
- Coin côté droite arrondi.
- Ángulo lateral derecho redondeado.



- Albero cardanico rinforzato.
- Hardened PTO drive shaft.
- Verstärkte Gelenkwelle.
- Arbre cardan.
- Árbol de transmisión.

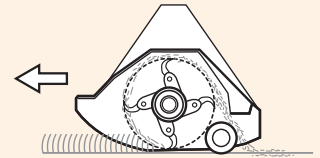

## OPTIONALS

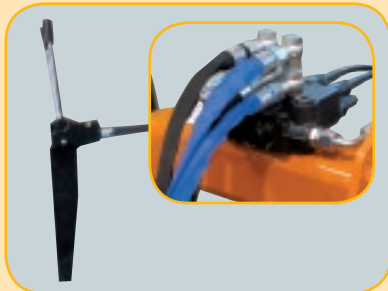

- Distributore a doppio effetto con leve e cavi flessibili.
- Double effect distributor with levers and with wire-cables.
- Doppelwirkendes Steuerventil mit Hebeln und Bowdenzügen.
- Distributeur hydraulique double effet à leviers avec téléflexibles en cabine.
- Distribuidor de doble efecto con levas y cables flexibles.

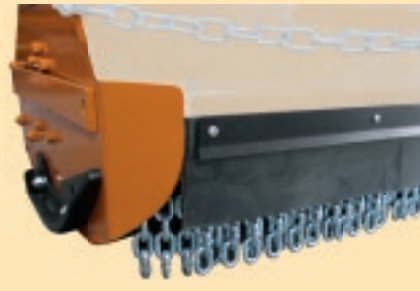

- Protezioni frontali in catena e gomma.
- Front chains protectors & rubber.
- Frontschutze mit Ketten + Gummi.
- Protections frontales par chaînes et caoutchouc.
- Protecciones frontales en cadenas con goma.



- Kit segnaletica stradale con luci.
- Set road-warning panels with lights.
- Satz Warntafel mit Beleuchtung.
- Kit de signalisation avec système d'éclairage.
- Kit de señalización de carretera con luces.



- Sistema antishock BERTI\*.
- Exclusive BERTI Anti-Shock Device\*.
- Anti-Schock System BERTI\*.
- Système antichoc exclusif BERTI\*.
- Dispositivo antichoque exclusivo de Berti\*.



- Slitte d'appoggio antiusura.
- Skids of anti-wearing steel.
- Satz Kufen mit Anti-Verschleißmaterial.
- Jeu patins anti-usure.
- Patines de acero reforzado anti-desgaste.



- Albero cardanico doppio omocinetico.
- Double Wide-Angle drive shaft.
- Doppel-Weitwinkel Gelenkwelle.
- Arbre cardan double homocinétique.
- Árbol de transmisión doble homocinético.

# TA/PS



**STRENX®**  
PERFORMANCE STEEL

- Valvola di blocco.
- Block valve.
- Sperrventilblock.
- Soupape de bloc.
- Válvula de bloque.

- Attacco terzo punto con sistema flottante e fermo di sicurezza.
- 3 point linkage with floating system and safety lock.
- Dreipunktbock mit Schwimmstellung-System und Sperrbolzen.
- Attelage à 3 points avec système flottante et arrêt de sécurité.
- Enganche a los tres puntos con sistema flotante y bloqueo de seguridad.

- Valvola di sicurezza.
- Safety valve.
- Sicherheitsventil.
- Soupape de sûreté.
- Válvula de seguridad.

- Tenditore automatico delle cinghie.
- Full automatic belts adjuster.
- Automatische Riemenspannung.
- Tendeur automatique des courroies.
- Tensor automático de las correas.

 Trinciatrice professionale multiuso da applicare a trattori con potenza compresa tra 90 e 200 HP. Adatta a lavorare sia posteriormente che lateralmente al trattore. E' consigliata per erba, residui vegetali, cespugli e sarmenti fino a  $\varnothing$  10 cm., ideale per la pulizia di parchi, aree verdi, giardini, bordi di strade, su fossati, argini e terreni inclinati in genere









 Heavy-duty offset / in-line mulcher for grass, residue of vegetables, bushes and pruning up to  $\varnothing$  10 cm., suited for tractors from 90 to 200 HP. Ideal machine for contractors who need to clear slopes, ditches, banks of watercourses, road side banks and public green areas in general.

 Universalgerät für Heckanbau, für seitliches Mulchen oder hinter dem Schlepper für Gras, Vegetation, Reisig und Äste mit  $\varnothing$  10 cm. für Randstreifen, für Wassergräben und für Böschungen für Traktoren von 90 bis 200 PS.

 Broyeur professionnel renforcé multifonctions pour broyer l'herbe, les déchets végétaux, les buissons et les sarments allant de  $\varnothing$  10 cm; adapté pour tracteurs de 90 à 200 CV. Machine idéale pour les personnes qui travaillent pour le compte de tiers et qui doivent nettoyer le rebord des routes, fossés, digues et espaces verts publiques.

 Trituradora profesional multiuso, de aplicar a tractores con potencia comprendida entre 90 y 200 HP. Apta para trabajar tanto posteriormente como lateralmente al tractor. Es recomendada para hierba, residuos vegetales, arbustos y sarmientos de  $\varnothing$  10 cm. Ideal para la limpieza de parques, áreas verdes, jardines, bordes de carreteras, zanjas, riberas y terrenos inclinados en general.

*Il trattore deve essere dotato di almeno n.2 prese d'olio a doppio effetto / The tractor has to be equipped with n. 2 double effect oil plugs / Der Traktor muss mit 2 doppelwirkenden Hydraulikanschlüssen ausgestattet sein / Le tracteur doit être équipé avec au moins 2 prises d'huile à double effet / El tractor deberá estar equipado con al menos dos enchufes hidráulicos con válvula de doble efecto.*

Mod.									
	cm	Min	Max	n°	n°	n°	PTO	min	max
<b>TA/PS 180</b>	173	90	200	16	48	5	540	1015	1170
<b>TA/PS 200</b>	193	100	200	18	54	5	540	1060	1215
<b>TA/PS 220</b>	213	100	200	20	60	5	540	1110	1265
<b>TA/PS 250</b>	243	100	200	22	66	5	540	1175	1330





- Sistema flottante con limitatore.
- Floating device, with limiter.
- Schwimmstellung-System mit Hubbegrenzer.
- Système flottante avec limiteur.
- Sistema de enganche flotante con limitador.



- Rullo autopulente regolabile in altezza.
- Self-cleaning and height adjustable roller.
- Selbstreinigender und höhenverstellbarer Stützwalze.
- Rouleau auto-nettoyant réglable en hauteur.
- Rodillo auto-limpiable regulable en altura.

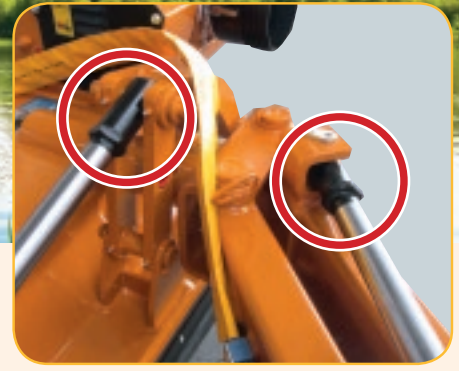

- Martinetti regolabili.
- Adjustable cylinders.
- Einstellbare hydr. Zylindern.
- Vérins réglables.
- Cilindros hidráulicos con extensión ajustable.



- Fiancata destra arrotondata.
- Chamfered profile on the right-end chassis corner.
- Seitlich Abschrägung auf Mulcherrahmen.
- Coin côté droite arrondi.
- Ángulo lateral derecho redondeado.



- Albero cardanico rinforzato.
- Hardened PTO drive shaft.
- Verstärkte Gelenkwelle.
- Arbre cardan.
- Árbol de transmisión.

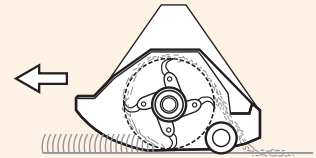
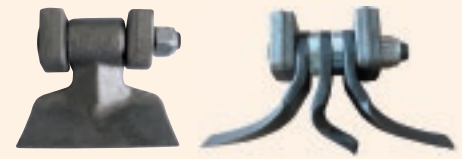

## OPTIONALS

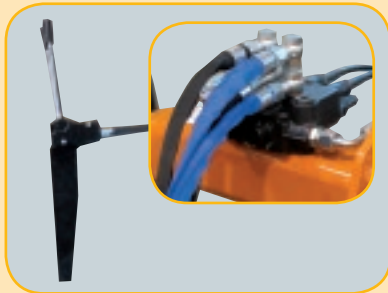

- Distributore a doppio effetto con leve e cavi flessibili.
- Double effect distributor with levers and with wire-cables.
- Doppelwirkendes Steuerventil mit Hebeln und Bowdenzügen.
- Distributeur hydraulique double effet à leviers avec téléflexibles en cabine.
- Distribuidor de doble efecto con levas y cables flexibles.

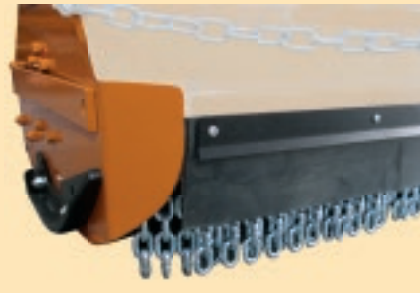

- Protezioni frontali in catena e gomma.
- Front chains protectors & rubber.
- Frontschutze mit Ketten + Gummi.
- Protections frontales par chaînes et caoutchouc.
- Protecciones frontales en cadenas con goma.



- Kit segnaletica stradale con luci.
- Set road-warning panels with lights.
- Satz Warntafel mit Beleuchtung.
- Kit de signalisation avec système d'éclairage.
- Kit de señalización de carretera con luces.



- Sistema antishock BERTI\*.
- Exclusive BERTI Anti-Shock Device\*.
- Anti-Schock System BERTI\*.
- Système antichoc exclusif BERTI\*.
- Dispositivo antichoque exclusivo de Berti\*.



- Slitte d'appoggio antiusura.
- Skids of anti-wearing steel.
- Satz Kufen mit Anti-Verschleißmaterial.
- Jeu patins anti-usure.
- Patines de acero reforzado anti-desgaste.



- Albero cardanico doppio omocinetico.
- Double Wide-Angle drive shaft.
- Doppel-Weitwinkel Gelenkwelle.
- Arbre cardan double homocinétique.
- Árbol de transmisión doble homocinético.

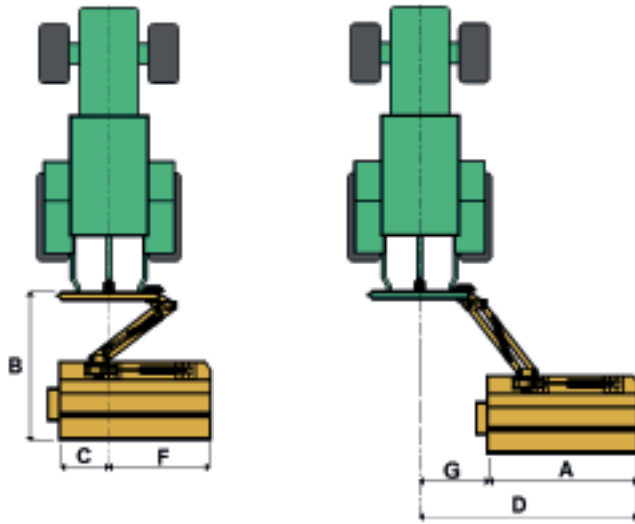

### TA/MI

Mod.	A	B	C	D	E	F	G
	cm	cm	cm	cm	cm	cm	cm
<b>TA/MI 145</b>	145	167	54	228	102	91	83
<b>TA/MI 160</b>	160	167	54	243	117	106	83
<b>TA/MI 180</b>	180	167	54	263	137	126	83
<b>TA/MI 200</b>	200	167	54	283	157	146	83

### TA/M

Mod.	A	B	C	D	E	F	G
	cm	cm	cm	cm	cm	cm	cm
<b>TA/M 145</b>	145	167	16	266	140	129	121
<b>TA/M 160</b>	160	167	16	281	155	144	121
<b>TA/M 180</b>	180	167	16	301	175	164	121
<b>TA/M 200</b>	200	167	16	321	195	184	121

### TA

Mod.	A	B	C	D	E	F	G
	cm	cm	cm	cm	cm	cm	cm
<b>TA 160</b>	160	170	59	240	113	101	80
<b>TA 180</b>	180	170	59	260	133	121	80
<b>TA 200</b>	200	170	59	280	153	141	80
<b>TA 220</b>	220	170	59	300	173	161	80
<b>TA 250</b>	250	170	59	330	203	191	80

### TA/S

Mod.	A	B	C	D	E	F	G
	cm	cm	cm	cm	cm	cm	cm
<b>TA/S 160</b>	160	170	17	283	151	143	123
<b>TA/S 180</b>	180	170	17	303	174	163	123
<b>TA/S 200</b>	200	170	17	323	194	183	123
<b>TA/S 220</b>	220	170	17	343	214	203	123

### TA/P

Mod.	A	B	C	D	E	F	G
	cm	cm	cm	cm	cm	cm	cm
<b>TA/P 160</b>	160	203	57	238	104	103	78
<b>TA/P 180</b>	180	203	57	258	124	123	78
<b>TA/P 200</b>	200	203	57	278	144	143	78
<b>TA/P 220</b>	220	203	57	298	164	163	78
<b>TA/P 250</b>	250	203	57	328	194	193	78

### TA/PS

Mod.	A	B	C	D	E	F	G
	cm	cm	cm	cm	cm	cm	cm
<b>TA/PS 180</b>	180	203	17	297	164	163	117
<b>TA/PS 200</b>	200	203	17	317	184	183	117
<b>TA/PS 220</b>	220	203	17	337	204	203	117
<b>TA/PS 250</b>	250	203	17	367	234	233	117



**\*ANTI-SHOCK BERTI**

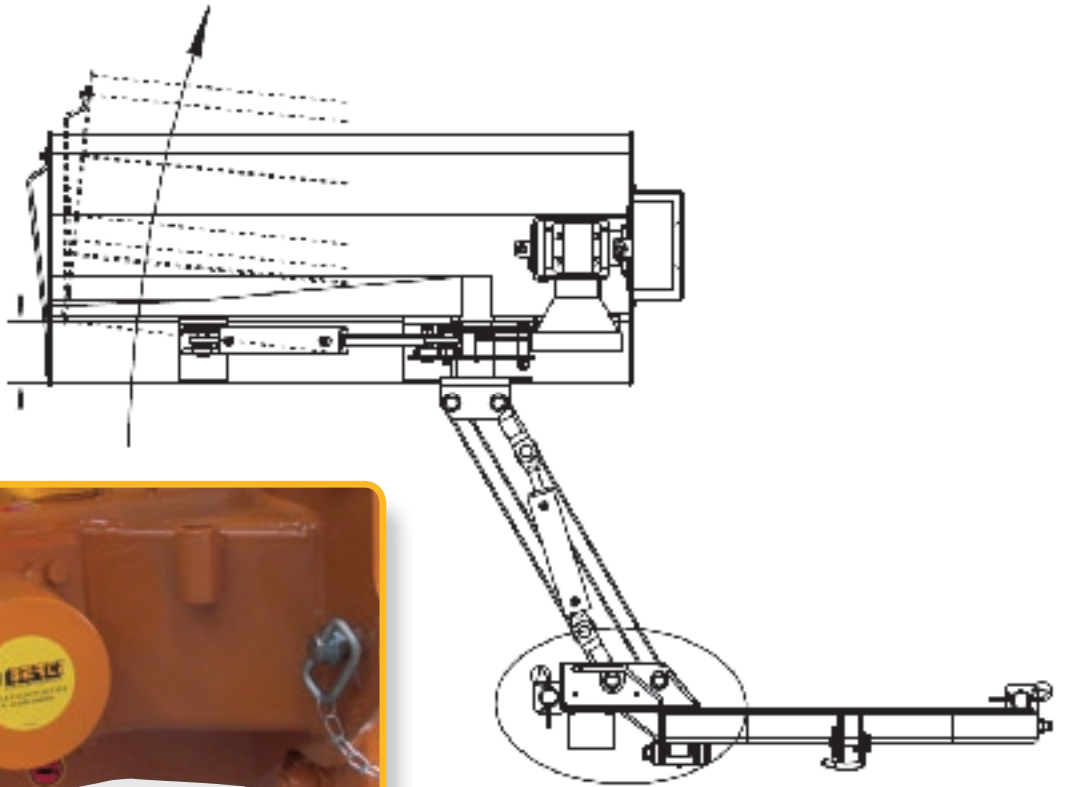



www.bertima.it



TA/MI



TA/M



TA



TA/S



TA/P

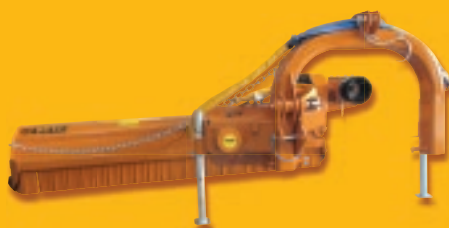

TA/PS

Le illustrazioni e i dati del presente catalogo sono indicative e non vincolanti per il costruttore • All pictures and data above are indicative only and not binding for the manufacturer • Alle in diesem Katalog enthaltenen Angaben und Zeichnungen sind annahmend und unverbindlich • Toutes les données insérées dans ce catalogue ont été indiquées seulement à titre de renseignement • Las fotografías y los datos mostrados son meramente indicativos y podrían ser variados sin previo aviso por el fabricante.



**BERTI**<sup>®</sup>  
MACCHINE AGRICOLE



Via Musi, 1/A-3 - 37042 Caldiero (VR) ITALY  
Tel. +39.045.6139711 - Fax +39.045.6150251  
info@bertima.it



 **MADE IN ITALY**