

210|220X
SERIES



INTRODUCING THE FIRST OF THE NEW X SERIES

Our vision from the start was to design and engineer our most advanced 20 tonne tracked excavator. In fact, our best ever.

Listening to customer demands, our engineering teams have obsessed over every minute detail of this world-class excavator. Using automotive quality materials and proven components, our design is both rugged and refined.

The result is a machine to be taken seriously.
A machine to be trusted.

Anthony Bamford

LORD BAMFORD, CHAIRMAN, JCB



X
SERIES

EXTREME STRENGTH

It's taken 4 years of hydraulic, electronic and electrical development and thousands of hours of extreme endurance testing, to build you a machine that doesn't just look extremely strong, it is extremely strong.





X
SERIES

EXTREME STRENGTH

Tested to extremes.

1 Whole machine shaker rig used to replicate 15,000 hours of tracking and vibration.

1.1 million test cycles completed on our latest dig end which has been proven by over 10,000 machines across the globe.

Exhaustive testing on purpose built electronics and electric rigs to prove connections, layout and software.

2 30,000 window and door operation tests completed to prove components quality.

3 Hot and cold climate testing (55°C to -30°C) performed in controlled conditions and locations around the world.

Exceptional build quality

4 Proven undercarriage with fully-welded X frame construction for long-term durability with components supplied by industry-leading suppliers.

5 SAE flange hydraulic fittings are extensively used to provide robust hose connections.

6 Rigid upper frame, flat revolver side skirts and double skinned doors with new plated hinges provide greater strength.

Extremely robust fold back mechanism for cab mirror.

Finite Element Analysis ensures longer life for key components.



EXTREME STRENGTH

ECOMAX RELIABILITY

Our engine technology is tried and proven; we've built 500,000 DIESELMAX units since 2004. To ensure similar longevity, the 210X and 220X DIESELMAX engines have been tested to 110,000 hours in 70 different machines across the toughest applications and environments.

EXTRA STRENGTH

Our latest boom and dipper is made of high tensile strength steel, reinforced with three-piece wrapper plates and cast ends for extra strength and durability.



EXCEPTIONAL COMFORT

We've used ergonomic design, automotive quality materials and engineering excellence to deliver exceptional comfort. And with ride comfort and low noise to rival the best in the business, there's enough to make even the most demanding operator extremely happy.





X
SERIES

EXCEPTIONAL COMFORT

LOW NOISE

Improved cab isolation using latest double cushion viscous mounts reduces vibration and noise into the cab. This helps deliver low in-cab noise of 67 dB(A).

CUSTOMER LED ERGONOMICS

Control layout reviewed and assessed by operators globally, with their feedback directly contributing to the final design.



Best operator environment.

1 Spacious JCB CommandPlus cab with high quality injection moulded interior. Industry-leading Grammer seat with wide, adjustable arm rests that reclines 145°.

New track pedal design with T-bars as standard with non-slip coating and optimised ergonomics.

2 Joystick and switch controls are mounted to pods which are suspended from the seat and move with the operator for optimum control and less fatigue.

3 Powerful new HVAC, with 11 targeted vents for optimum performance in hot and cold environments. Cool/heat box as standard.

4 Industry standard isolator lever operation prevents accidental activation when exiting the cab.

5 Spacious luggage tray behind operators seat with 3 independent 12V power supplies. Another handy storage space can be found at the back of the cab in the roof liner, including a hanger for the operator's helmet.

6 Bluetooth radio is fully integrated into the control screen.





EXCELLENT CONTROL

**4 years of hydraulic development combined with the latest Japanese components
have delivered the very best balance of controllability and efficiency.**





JCB

220XLC

JCB

X
SERIES

EXCELLENT CONTROL



Effortless working.

1 Latest generation Japanese hydraulics deliver precise and efficient control.

2 Operator can select Auto-Stop and Auto-Idle depending on preference.

3 Customisable proportional controls allow the operator to set their preference of speed and control of attachments.

New dozer option adds extra versatility.

Power boost button increases pressure by 10% for up to 9 seconds to provide extra tearout in tough conditions.

4 Tracking speed can be found on the joystick for on the move tracking change, whilst a convenience button lets you configure a range of functions such as radio mute, camera cycle, or front screen wash.

5 New slew drive provides high torque on acceleration and braking for greater controllability and refinement.





EXCELLENT CONTROL

EXTRA EFFICIENCY

Boom float feature allows for smooth grading along hard surfaces and improves breaker efficiency by applying the correct amount of pressure on the breaker tool.

X
SERIES

EXTREMELY EASY

Using latest ergonomic design and with the help of customer and operator feedback, the new 210X and 220X have been designed to be easy to use and easy to transport making it easy to get more work done.





JCB

JCB

JCB

220X LC

X
SERIES

EXTREMELY EASY

HOSE BURST CHECK VALVE

Factory fitted HBCVs means the machine is ready for lifting operations. Optional bucket HBCVs are available for fork use.



Best-in-class ease of use.

1 Start-stop button for ease of start-up means the operator doesn't have to turn the key to start it back up again. The start sequence also allows you to start digging within 2 seconds.

An intuitive menu navigation can be configured into multiple languages to suit most operators.

2 Pipework shut-off taps now added as standard with SAE fittings, to enable quick connection of attachments when taking a hydraulic option.

3 Easy quickhitch provides simplified operation with an override for removing large breakers or fork attachments.

4 Advanced tool select system improves attachment handling by monitoring pressure and flow. There is tool storage as standard for up to 10 tools.

5 Machine lifting and transportation has been made easier due to dedicated lifting points and because the 210X and 220X are only 3.1m high, they can be transported on 900mm trailer beds which meets transport legislation (specification dependant).

6 The cab includes mounts as standard to allow guards to be fitted in the field and also includes flat front glass for easy replacement.







EXPERIENCE GREATER PERFORMANCE

We've invested 4 years of research and development and listened to 1,000 customers like you to build a machine that's ready to perform in the most extreme conditions; 55°C heat or freezing temperatures.

A machine that works with extreme efficiency on the demolition site or non-stop in the quarry.





X
SERIES

EXPERIENCE GREATER PERFORMANCE

Best-in-class productivity.

1 Hydraulic pipes and hoses have a large diameter for increased productivity and efficiency. An innovative hydraulic regeneration system means oil is recycled across the cylinders for faster cycle times and reduced fuel consumption.

2 Large diameter rotary coupling between the upper and lower structures provides better efficiency and productivity.

3 2.7m wide upper structure with a centrally mounted boom provides a centralised dig path and reduced slew bearing loading.

4 Auto-stop and Auto-idle on the JCB's 448 DIESELMAX Stage V engine provides fuel saving of up to 5%.

Machine cooling in 55°C heat with air conditioning running has been achieved with a bigger fan.

5 For extra versatility, JCB offers a full list of auxiliary pipework options including hammer, merged pump flow, auxiliary, and low flow.

6 Long reach and T.A.B. dig ends with low flow auxiliaries and lighting systems are also available.



EXPERIENCE GREATER PERFORMANCE

GPS

GPS factory ready option to facilitate fitment of 2D and 3D systems.

EXTREME TEAROUT

Best-in-class productivity lets you move more, with a massive 15200 kgf bucket tear out and fast cycle times.



EXTRAORDINARY ATTENTION TO DETAIL

Building the new 210X and 220X involved a huge investment in state-of-the-art automotive style production facilities. We introduced new tooling, EPD coating, robot welding and established new relationships with many industry-leading suppliers to bring you not just great excavators but exceptional ones.





EXTRAORDINARY ATTENTION TO DETAIL

THOUGHTFUL DESIGN

The whole design is optimised to protect the machine; side bay doors sit back from the edge for protection and the right hand platform corner and handrail sit within the slew radius to prevent damage and scratching.

EPD COATING

EPD coating improves corrosion resistance and ensures 100% coverage of metal components including hard to cover areas like edges and cavities, while powder coat paint guarantees a constant quality finish.

World-class finish.

1 All components are painted in house using a state-of-the-art paint facility to deliver a high quality finish that's checked for paint adhesion and coverage.

All machines undergo 1,232 validation checks including an intense hot test focusing on vibration, pressure and heat to replicate real-life applications.

2 Significantly reduced vented and open areas means inherently stronger bodywork and reduced painted edges.

3 Doors are bolted directly to the house frame and remain rust-free due to a zinc coating on all wear faces. All fasteners have a zinc finish (Geomet) for improved corrosion resistance, a new bolt and washer design protects paint from damage.

4 New recessed counterweight design protects the rear end and machine branding from impact damage.



World-class assembly.

5 Robot welding of the dig end and undercarriage ensures consistent quality and accuracy.

6 The slew ring is machined after manufacturing and welding to ensure a flat surface that reduces slewing noise.

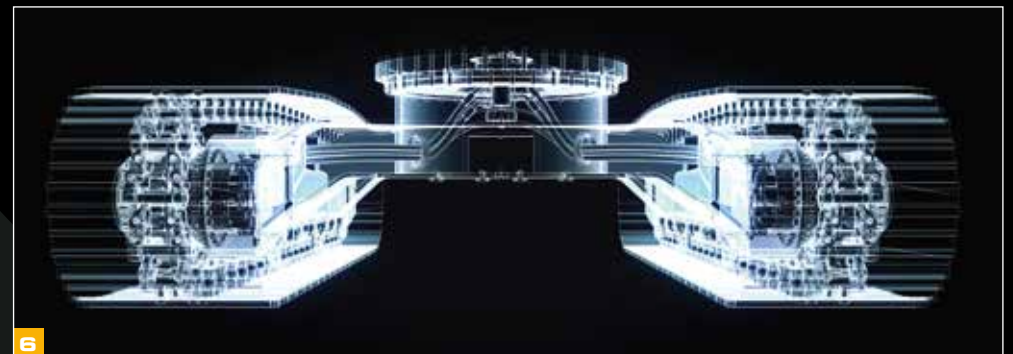
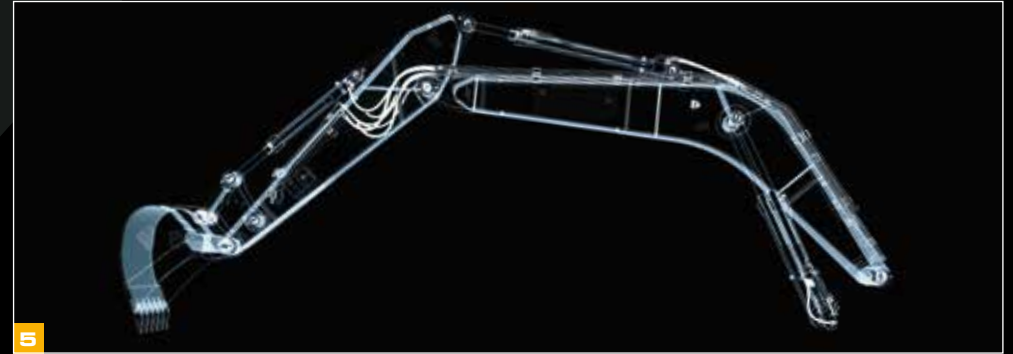

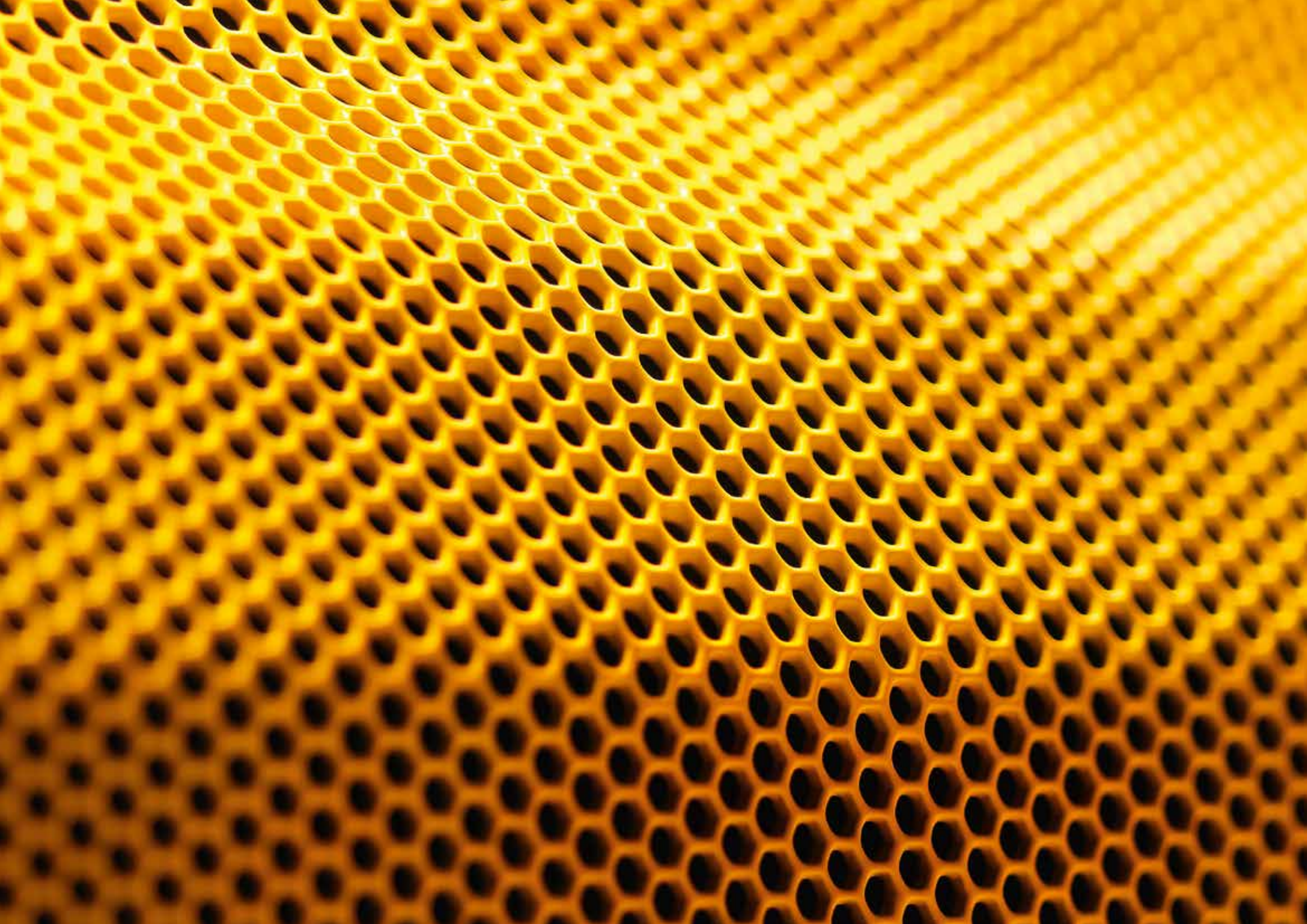



X
SERIES

EXTENDED SERVICE INTERVALS

The new 210X and 220X have been designed with greater productivity in mind and that means spending more time working and less time being serviced. Longer service intervals, quality parts and easy access to maintenance points all help to save you time and money.





EXTENDED SERVICE INTERVALS

Simple servicing.

- 1** Grouped greasing points make regular maintenance easier and quicker.
- 2** The refuelling pump fitted as standard has an optional in-line fuel filter to protect the pump and engine.
- 3** Ground level access to hour meter, HVAC filter, cab air filter and single fuse box. Optional LED convenience lighting for the service bay and upper structure.
- 4** Bolt-on handrails and mirrors for easy replacement if damaged.
- 5** Large cooling pack means more efficient cooling due to wider spacing fins which reduce clogging. 2,000 hour engine air filter life achieved using a standard fit system.
- 6** A cover over the battery provides useful storage space in addition to the tool box.



EXTENDED SERVICE INTERVALS

BRONZE BUSHES

Graphite impregnated bronze bushes on the boom and dipper pivots for 250 hour greasing intervals.

REDUCED SERVICING

Only 10 checks required for a 500 hour service. Main hydraulic filter service interval extended to 2000 hours from 1000 hours. High grade engine oil and new fuel filters only need to be changed after 500 hours.



EXCEEDINGLY SAFE

At JCB we take safety very seriously and we make sure this forms an important part of the design process. So whether you're an operator, service engineer or site worker, we make working safer.

Safer working.

- 1 The 210X and 220X boast anti-slip surfaces and comfortable, well positioned grab handles and an area free of tread plate dimples to allow for kneeling during servicing.
- 2 Flattest, safest operator access to the top of the machine with built in kick strips around the edges.
- 3 Optional twin or 360° cameras helps operators operate safely.
- 4 Operator safety is paramount to JCB and the optional dipper limiter can be configured through the display to avoid a cab strike.



EXCEEDINGLY SAFE

OPERATOR PROTECTION

Side guard rails on upper structure as standard. Optional full upper guard rails are available.

AUTHORISED USE

Immobiliser pin code management allows you to remotely authorise usage of the machine – perfect for rental companies.

EXTRA SUPPORT

In a world of tough business decisions where the customer rightfully expects the very best in machine back up and a complete package of value added solutions, JCB delivers. Whatever you need and wherever you are, JCB's worldwide customer support is truly first-class.

Machine efficiency.

By providing information like idle time monitoring and fuel consumption, JCB LiveLink saves you money and improves productivity.

Machine reliability.

Accurate hours monitoring and service alerts improve maintenance planning and help rental companies with accurate charging. Technical alerts and maintenance history records help you manage your machines.

Machine monitoring.

Keep track of what your machine's been doing throughout the day with regular performance reports accessed via the LiveLink website.

Machine security.

LiveLink's real time geo-fencing alerts tell you when machines move out of predetermined zones. Curfew alerts inform you of unauthorised usage. JCB have a history of working with the police to recover stolen machines and tackle fuel theft.

LIVE  LINK

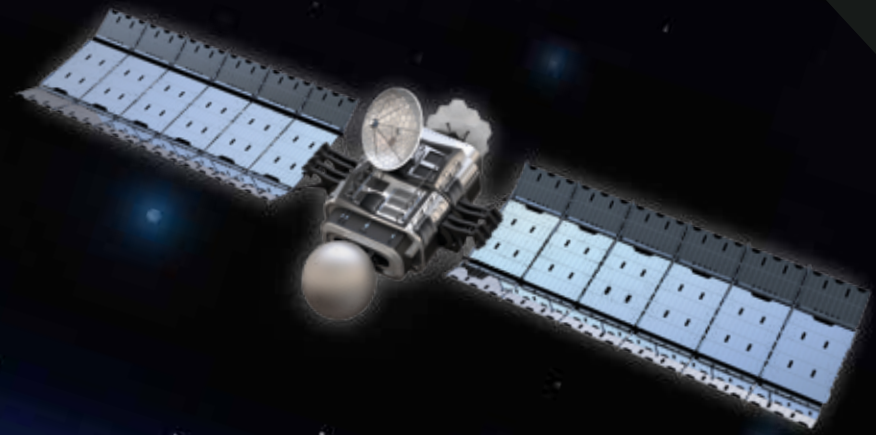

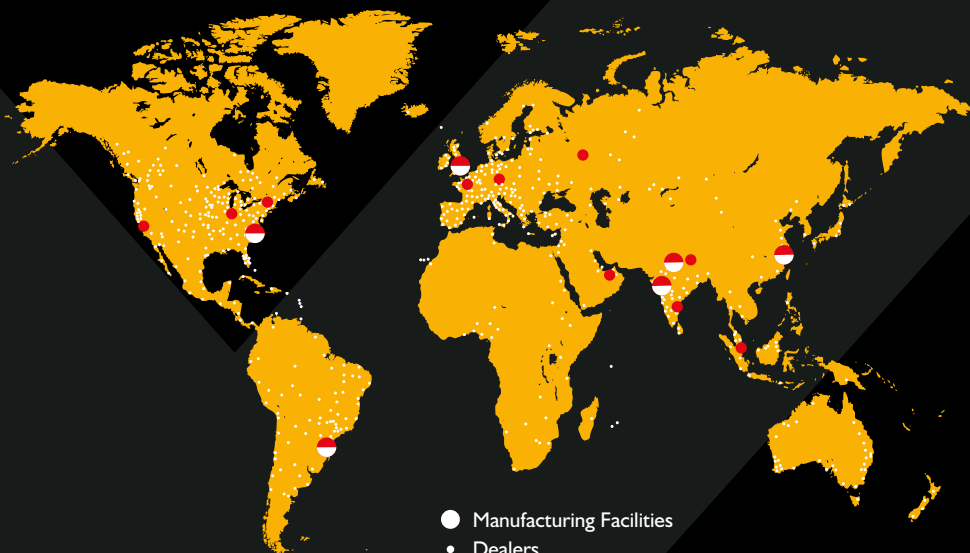

- Manufacturing Facilities
- Dealers
- Parts Distribution Centres

1 Our Technical Support Service provides instant access to factory expertise, day or night, while our Finance and Insurance teams are always on hand to provide fast, flexible, competitive quotes.

2 The global network of JCB Parts Centres is another model of efficiency; with 16 regional bases, we can deliver around 95% of all parts anywhere in the world within 24 hours. Our genuine JCB parts are designed to work in perfect harmony with your machine for optimum performance and productivity.

3 JCB Assetcare offers comprehensive extended warranties and service agreements, as well as service-only or repair and maintenance contracts. Irrespective of what you opt for, our maintenance teams around the world charge competitive labour rates, and offer non-obligation quotations as well as fast, efficient insurance repair work.

Note: JCB LIVELINK and JCB ASSETCARE may not be available in your region, so please check with your local dealer.



1



2



3





SPECIFICATION 210X LC/SC, 220X LC/SC/SLC

STATIC DIMENSIONS

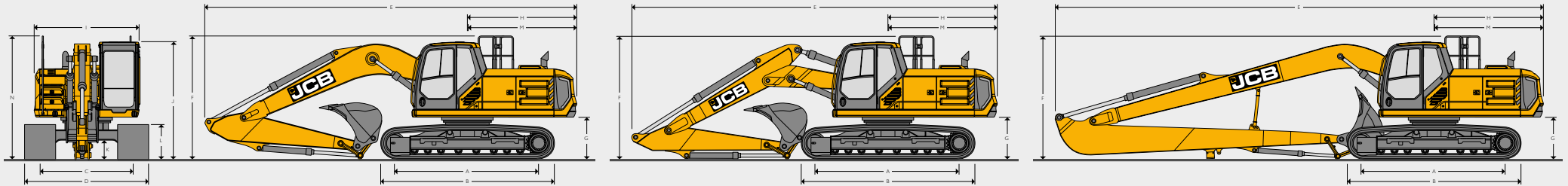

STATIC DIMENSIONS

Model		210X LC, 220X LC		220X SLC		210X SC, 220X SC	
A	Track length on ground	mm	3660		3660		3370
B	Undercarriage overall length	mm	4460		4460		4170
C	Track gauge	mm	2390		2170		2170
D	Width over tracks (500mm trackshoes)	mm	2890		2670		2670
D	Width over tracks (600mm trackshoes)	mm	2990		2770		2770
D	Width over tracks (700mm trackshoes)	mm	3090		2870		2870
D	Width over tracks (800mm trackshoes)	mm	3190		2970		2970
D	Width over tracks (900mm trackshoes)	mm	3290		-		-
G	Counterweight clearance	mm	1077		1077		1077
H	Tail length	mm	2813		2813		2813
I	Overall width of superstructure	mm	2698		2698		2698
I	Overall width of superstructure (with SIPS)	mm	2828		2828		2828
J	Height over cab	mm	3020		3020		3020
J	Height over XD guard	mm	3120		3120		3120
J	Height over cab (vandal guard – optional)	mm	3330		3330		3330
K	Ground clearance	mm	485		485		485
L	Track height	mm	885		885		885
M	Tail swing radius	mm	2846		2846		2846
N	Overall height of upper structure	mm	3170		3170		3170
			Mono		T.A.B		LR
Dipper lengths			2.4m	3.0m	2.4m	3.0m	6.4m
E	Transport length	mm	9624	9562	9622	9409	12546
F	Transport height (handrail folded – optional)*	mm	3200	3086	3266	3152	3079
	Transport height (fixed handrail – standard)	mm	3200	3170	3266	3170	3170

ENGINE

Model	JCB 448 DIESELMAX Stage V
Type	4 stroke, 4 cylinder in-line, direct injection, turbocharged diesel.
Rated power (net)	129 kW (173 hp).
Piston displacement	4.8 litres.
Air filtration	Dry element with in cab warning indicator.
Starting system	24 volt.
Batteries	2 x 12 volt.
Alternator	28 volt - 100 ampere.
Maximum torque	690 Nm @ 1500 rpm.
Bore and stroke	106 x 135 mm.

SWING SYSTEM

Swing motor	Axial piston type.
Swing brake	Hydraulic braking plus automatic spring applied disc type parking brake.
Swing torque	68.7 kNm.
Swing speed	11.0 rpm.
Swing gear	Large diameter, internally toothed fully sealed grease bath lubricated.
Swing lock	Switchable brake in cab.

* excludes FOPS guard / XD FOPS guard.

TRACK DRIVE	
Type	Fully hydrostatic, two speed with autoshift.
Travel motors	Variable swash axial piston type, fully guarded within undercarriage frame.
Final drive	Planetary reduction, bolt-on sprockets.
Service brake	Hydraulic counter balance valve.
Park brake	Disc type, spring applied, automatic hydraulic release.
Gradeability	70% (35°) continuous.
Travel speed	High – 5.7 km/h. Low – 3.2 km/h.
Tractive effort	207.5 kNm.

SERVICE CAPACITIES		
Fuel tank	Litres	387
Engine coolant	Litres	38
Engine oil	Litres	20.4
Swing reduction gear	Litres	8
Track reduction gear (each side)	Litres	3.5
Hydraulic system	Litres	250
Hydraulic tank	Litres	120
DEF fluid	Litres	47.7

UNDERCARRIAGE					
Carriage options	SC – Standard, LC – Long Carriage, SLC – Standard Long Carriage.				
Construction	Fully welded 'X' frame type with central bellyguarding and sloping sidemembers with dirt relief holes under top rollers.				
Recovery point	Front and rear.				
Upper and lower rollers	Heat treated, sealed and lubricated.				
Track adjustment	Grease cylinder type.				
Track idler	Sealed and lubricated, with spring cushioned recoil.				
Track type	Sealed and lubricated.				
Track shoe options	500mm	600mm	700mm	800mm	900mm
	SC	SC	SC	SC	–
	LC	LC	LC	LC	LC
	SLC	SLC	SLC	SLC	–
	LC, SLC		SC		
No. of upper rollers (per side)	2		2		
No. of lower rollers (per side)	8		7		
No. of track guides (per side)	2		2		
No. of track shoes (per side)	49		46		

SOUND LEVEL	
Operator Sound Pressure Level – ISO 6396: 2008	67 (TBC) dB LpA
Exterior Sound Pressure Level – ISO 6396: 2008 & EU Directive 2000/14/EC	102 (TBC) dB LwA

HYDRAULIC SYSTEM	
Pumps	
Main pumps	2 variable displacement axial piston type.
Maximum flow	2 x 228 l/min.
Servo pump	Gear type.
Servo pump maximum flow	16 l/min.
Control valve	
A combined four and five spool control valve with auxiliary service spool as standard.	
Relief valve settings	
Boom/Arm/Bucket	343 bar.
With power boost	373 bar.
Swing circuit	250 bar.
Travel circuit	343 bar.
Pilot control	39 bar.
Filtration	
In tank	105 micron, suction strainer.
Main return line	10 micron, glass fibre element.
Pilot drain line	10 micron, glass fibre element.
Pilot line	10 micron, glass fibre element.
Hydraulic hammer return	10 micron, reinforced microform element.

	Quantity	Bore mm	Rod diameter mm
Boom	2	125	85
Arm	1	130	95
Bucket	1	115	85
LR Bucket	1	95	70
TAB position	1	140	95

OPTIONAL BLADE – 220X LC

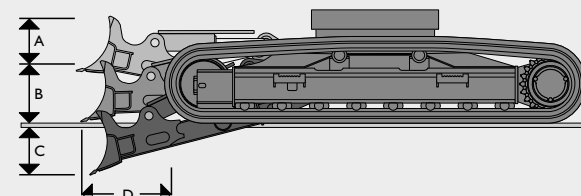

A	Blade height	mm	600
B	Blade lift above ground	mm	410
C	Blade cut below ground	mm	440
D	Blade forward of track	mm	567
	Dozer width – 600mm tracks	mm	2990
	Dozer width – 700mm tracks	mm	3110

Additional machine weight with blade		
600mm tracks	kg	1588
700mm tracks	kg	1602

SPECIFICATION 210X LC/SC, 220X LC/SC/SLC

BUCKET AND ARM COMBINATION - MONOBOOM

Bucket options	GP Bucket								HD Bucket							
	mm	600	700	900	1100	1200	1350	1500	600	750	900	1100	1200	1350	1500	
Bucket width	m ³	0.38	0.51	0.66	0.81	0.95	1.10	1.25	0.38	0.52	0.66	0.81	0.95	1.11	1.25	
Bucket weight	kg	506	565	637	691	763	817	889	544	610	691	752	813	894	955	
210X SC																
2.4m Quickhitch (No Quickhitch)		☐ (☐)	☐ (☐)	☐ (☐)	☐ (☐)	☐ (☐)	☐ (☐)	■ (☐)	☐ (☐)	☐ (☐)	☐ (☐)	☐ (☐)	☐ (☐)	☐ (☐)	■ (☐)	
3.0m Quickhitch (No Quickhitch)		☐ (☐)	☐ (☐)	☐ (☐)	☐ (☐)	☐ (☐)	■ (☐)	● (■)	☐ (☐)	☐ (☐)	☐ (☐)	☐ (☐)	☐ (☐)	■ (☐)	● (■)	
210X LC																
2.4m Quickhitch (No Quickhitch)		☐ (☐)	☐ (☐)	☐ (☐)	☐ (☐)	☐ (☐)	☐ (☐)	☐ (☐)	☐ (☐)	☐ (☐)	☐ (☐)	☐ (☐)	☐ (☐)	☐ (☐)	☐ (☐)	
3.0m Quickhitch (No Quickhitch)		☐ (☐)	☐ (☐)	☐ (☐)	☐ (☐)	☐ (☐)	☐ (☐)	■ (☐)	☐ (☐)	☐ (☐)	☐ (☐)	☐ (☐)	☐ (☐)	☐ (☐)	■ (☐)	
220X SC																
2.4m Quickhitch (No Quickhitch)		☐ (☐)	☐ (☐)	☐ (☐)	☐ (☐)	☐ (☐)	☐ (☐)	☐ (☐)	☐ (☐)	☐ (☐)	☐ (☐)	☐ (☐)	☐ (☐)	☐ (☐)	☐ (☐)	
3.0m Quickhitch (No Quickhitch)		☐ (☐)	☐ (☐)	☐ (☐)	☐ (☐)	☐ (☐)	☐ (☐)	■ (☐)	☐ (☐)	☐ (☐)	☐ (☐)	☐ (☐)	☐ (☐)	☐ (☐)	■ (☐)	
220X LC																
2.4m Quickhitch (No Quickhitch)		☐ (☐)	☐ (☐)	☐ (☐)	☐ (☐)	☐ (☐)	☐ (☐)	☐ (☐)	☐ (☐)	☐ (☐)	☐ (☐)	☐ (☐)	☐ (☐)	☐ (☐)	☐ (☐)	
3.0m Quickhitch (No Quickhitch)		☐ (☐)	☐ (☐)	☐ (☐)	☐ (☐)	☐ (☐)	☐ (☐)	■ (☐)	☐ (☐)	☐ (☐)	☐ (☐)	☐ (☐)	☐ (☐)	☐ (☐)	■ (☐)	
220X SLC																
2.4m Quickhitch (No Quickhitch)		☐ (☐)	☐ (☐)	☐ (☐)	☐ (☐)	☐ (☐)	☐ (☐)	☐ (☐)	☐ (☐)	☐ (☐)	☐ (☐)	☐ (☐)	☐ (☐)	☐ (☐)	☐ (☐)	
3.0m Quickhitch (No Quickhitch)		☐ (☐)	☐ (☐)	☐ (☐)	☐ (☐)	☐ (☐)	☐ (☐)	■ (☐)	☐ (☐)	☐ (☐)	☐ (☐)	☐ (☐)	☐ (☐)	☐ (☐)	■ (☐)	

☐ = Suitable for general excavating materials up to 2000kg/m³.

■ = Suitable for light excavating materials up to 1600kg/m³.

● = Suitable for grading and loading materials up to 1200kg/m³.

These recommendations are given as a guide based on typical operating conditions.

Please contact your distributor for the correct selection of buckets and attachments to suit the application.

WEIGHTS AND GROUND BEARING PRESSURES

Figures include 1.1m³. bucket 778kg, operator, full fuel tank and 2.4m dipper.

		500mm shoes	600mm shoes	700mm shoes	800mm shoes	900mm shoes
210X SC Monoboom						
Machine weight	kg	21602	21838	22094	22406	-
Ground bearing pressure	kg/cm ²	0.56	0.47	0.41	0.36	-
210X LC Monoboom						
Machine weight	kg	22037	22288	22561	22891	23126
Ground bearing pressure	kg/cm ²	0.53	0.44	0.39	0.34	0.31
220X SC Monoboom						
Machine weight	kg	22502	22738	22994	23306	-
Ground bearing pressure	kg/cm ²	0.58	0.49	0.42	0.37	-
220X SC T.A.B.						
Machine weight	kg	23218	23455	23710	24023	-
Ground bearing pressure	kg/cm ²	0.60	0.50	0.44	0.39	-

WEIGHTS AND GROUND BEARING PRESSURES

Figures include 1.1m³. bucket 778kg, operator, full fuel tank and 2.4m dipper.

		500mm shoes	600mm shoes	700mm shoes	800mm shoes	900mm shoes
220X SLC Monoboom						
Machine weight	kg	22730	23002	23275	23605	-
Ground bearing pressure	kg/cm ²	0.54	0.46	0.40	0.35	-
220X LC Monoboom						
Machine weight	kg	22937	23188	23461	23791	24026
Ground bearing pressure	kg/cm ²	0.55	0.46	0.40	0.36	0.32
220X LC T.A.B.						
Machine weight	kg	23653	23905	24177	24508	24743
Ground bearing pressure	kg/cm ²	0.57	0.48	0.41	0.37	0.37
220X LC LR						
Machine weight	kg	23461	23712	23985	24315	24550
Ground bearing pressure	kg/cm ²	0.56	0.47	0.41	0.36	0.33

WORKING RANGE – MONOBOOM 5.7M

Dipper length:		2.4m	3.0m
A	Maximum digging reach	mm 9361	9859
B	Maximum digging reach (on ground)	mm 9171	9679
C	Maximum digging depth	mm 6096	6694
D	Maximum digging height	mm 9002	9087
E	Maximum dumping height	mm 6408	6537
F	Maximum vertical wall cut depth	mm 5368	5706
G	Minimum swing radius	mm 3331	2884
H	Minimum dumping height	mm 2906	2306
	Bucket rotation	degrees 183	183
	Maximum dipper tearout	kN 126.6	106.1
	Maximum bucket tearout	kN 150	150

WORKING RANGE – T.A.B. 5.7M

Dipper length:		2.4m	3.0m
A	Maximum digging reach	mm 9418	9955
B	Maximum digging reach (on ground)	mm 9229	9776
C	Maximum digging depth	mm 5716	6297
D	Maximum digging height	mm 10514	10890
E	Maximum dumping height	mm 7742	8120
F	Maximum vertical wall cut depth	mm 4841	5418
G	Minimum swing radius	mm 2602	2275
H	Minimum dumping height	mm 3683	3008
	Bucket rotation	degrees 183	183
	Maximum dipper tearout	kN 125	103.4
	Maximum bucket tearout	kN 148	148

WORKING RANGE – LR 8.7M

Dipper length:		6.4m
A	Maximum digging reach	mm 15628
B	Maximum digging reach (on ground)	mm 15514
C	Maximum digging depth	mm 11985
D	Maximum digging height	mm 12710
E	Maximum dumping height	mm 10451
F	Maximum vertical wall cut depth	mm 9307
G	Minimum swing radius	mm 5427
H	Minimum dumping height	mm 1730
	Bucket rotation	degrees 183
	Maximum dipper tearout	kN 68.4
	Maximum bucket tearout	kN 99.8

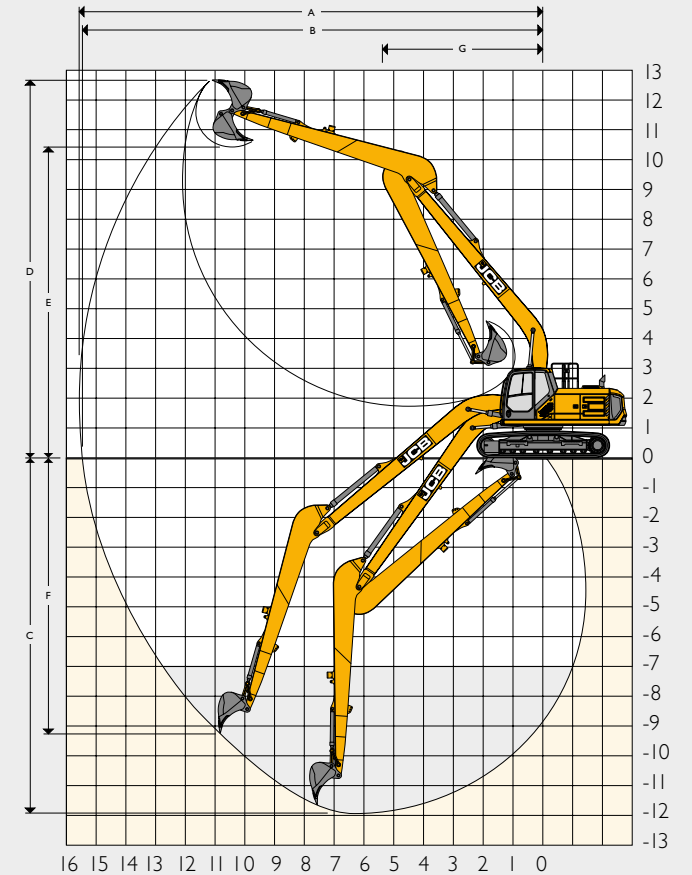
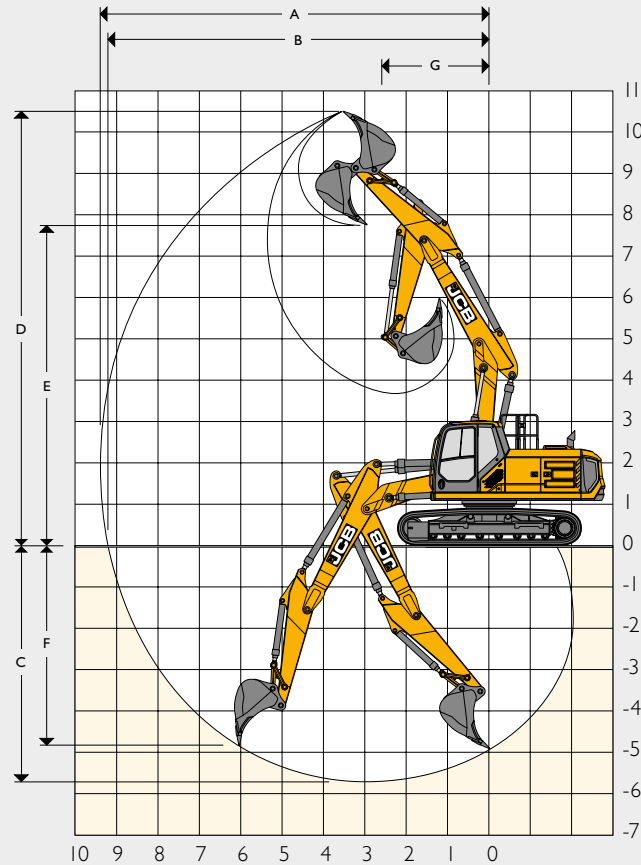
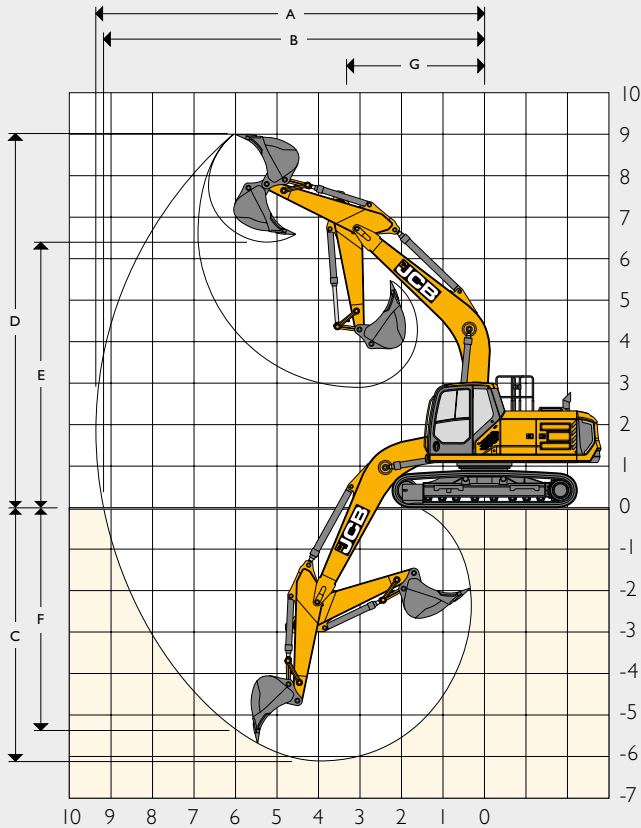

Working dimensions calculated using 980/B0092 GP bucket on Monoboom and T.A.B. and 980/A0391 GP bucket on LR.



SPECIFICATION 210X LC/SC, 220X LC/SC/SLC

STANDARD/OPTIONAL EQUIPMENT











ENGINE		CAB & INTERIOR		HYDRAULIC SYSTEM	
JCB 448 DIESELMAX Stage V compliant, SCR, water cooled diesel turbocharged after cooled electronic 4 cylinder 4.8 litre engine	•	Sound-insulated and 4 dual shock mounted cab	•	Boom and arm flow regeneration	•
Start pre-heat	•	Opening front window and removable lower front window	•	One touch power boost	•
One touch idle	•	Upper door sliding glass in 2 directions	•	Boom/slew priority control	•
Auto-idle function	•	Upper windscreen wiper	•	Cushion control	•
Automatic engine shutdown	•	4 button joysticks	•	Cylinder cushioning and contamination seals	•
Fan guard	•	Travel pedals and T handle levers	•	2 speed track motors	•
Heavy-duty batteries	•	2 foot rests	•	Oil cooler	•
Fuel filter with sedimenter	•	Immobiliser	•	I/O attachment settings through the display	•
Electronic engine control	•	Loudspeakers and connection for radio	•	High, merged, medium and low flow options (shut off taps as standard)	+
Fuel cooler	•	Standard cab filtration	•	Advanced tool select to control flow and pressure	+
Refuelling pump with inline filter	•	Electric dual tone horn	•	Proportional control joystick sliders with electronic foot pedal	+
Additional fuel filter with water separator	+	Interior cab light	•	Bio oil	+
SAFETY		3 x 12v sockets	•	Panolin oil	+
Side guard rails on upper structure and steps	•	7" colour monitor	•	Quickhitch pipework	+
Rear view camera	•	Retractable 2" seat belt	•	Hydraulic quickhitch	+
Battery isolator	•	Fixed roof glass	•	ISO/SAE change over	+
Key	•	Roof blind	•	SAE to BSP converters on high flow auxiliary pipework	+
Lockable fuel tank cap	•	Cool box	•	Quick release couplings	+
Lockable hydraulic tank cap	•	Cup holder	•	Hose burst check valves (boom, arm & bucket)	+
Work lights (2 revolving frame, 2 boom mounted)	•	Climate control	•	Boom float	+
Roll over protective structure (ROPS)	•	3" seat belt	+	Auxiliary vent to tank	+
Travel alarm	•	2" hi vis seat belt	+	Attachment case drain	+
Additional light options (Levels 2 & 3 available in halogen or LED)	+	3" hi vis seat belt	+	DIG END	
White noise alarm	+	Front, rear and side window blind	•	Grouped greasing	•
Demolition cage (FOPS Level II) – XD build only	+	Bluetooth radio (linked to pod controls and screen)	•	Auto greasing	+
Green beacon linked to seat belt	+	Carbon air filter	+	Dippers 2.4m, 3.0m	+
FOPS Level II guard top and front	+	Deluxe seat: Heated, adjustable air suspension seat with adjustable headrest mechanical lumbar support	•	HD dipper 2.4m, 3.0m	+
Fire extinguisher (1kg powder)	+	Super deluxe seat: Heated and air ventilation, adjustable air suspension seat with adjustable head rest and electric lumbar support	+	Lifting hook tipping link	+
Vandal guards	+	Rain guard visor	+	Lifting shackle tipping link	+
Chevron counterweight	+	Dual front wiper	+	Bucket ram guard	+
Rotating roof beacon	+	UNDERCARRIAGE		Triple articulated boom	+
2 x counterweight beacons	+	Greased and sealed track links	•	Guards for boom mounted lights	+
Twin camera	+	Twin track guards	•	OTHER	
360 degree camera	+	Full length track guards	+	Hour meter	•
Folding handrails	+	500, 600, 700, 800, 900 mm triple grouser shoe	+	Toolbox and storage tray	•
Full upper surrounding handrails	+	Dozer for LC carriage 600mm or 700mm tracks	+	Wide core radiators	•
Arm limiter	+			LiveLink telematics	•
				HD slew bearing seal	•
				I/Omm heavy-duty plates for upper and lower structure	+
				Pleated radiator flyscreen	+
				Work light guards	+
				Service bay and access lighting	+
				GPS ready	+
				Side impact protection revolving frame	+
				Shovel storage	+
				Toolkit	•

STANDARD •
OPTIONAL +

LIFT CAPACITIES – DIPPER LENGTH: 2.4M, MONOBOOM: 5.7M, TRACKSHOES: 500MM, NO BUCKET **210X SC MONO**

Reach	3m		4.5m		6m		7.5m		Capacity at Max. Reach		mm
											
Load Point Height	kg	kg	kg	kg	kg	kg	kg	kg	kg	kg	mm
6m					5400*	4580			5400*	3720	6760
4.5m			6860*	6860*	5860*	4430			4790	3080	7491
3m			8670*	6350	6640	4200	4700	3000	4350	2770	7872
1.5m			9950	5900	6390	3980	4590	2900	4210	2660	7954
0m			9710	5700	6240	3840	4520	2840	4320	2720	7746
- 1.5m	10960*	10820	9680	5670	6190	3800			4770	2980	7223
- 3m	13500*	11010	9770*	5770	6280	3880			5860	3650	6305
- 4.5m	10130*	10130*	7170*	6060					6590*	5600	4767

LIFT CAPACITIES – DIPPER LENGTH: 3.0M, MONOBOOM: 5.7M, TRACKSHOES: 500MM, NO BUCKET **210X SC MONO**

Reach	3m		4.5m		6m		7.5m		Capacity at Max. Reach		mm
											
Load Point Height	kg	kg	kg	kg	kg	kg	kg	kg	kg	kg	mm
7.5m					4670*	4670			3980*	3980*	6235
6m									3730*	3280	7339
4.5m					5300*	4490	4830	3110	3690*	2760	8017
3m	12250*	11930	7800*	6480	6140*	4230	4710	3000	3810*	2500	8374
1.5m			9550*	5950	6400	3980	4580	2880	3820	2390	8451
0m	6500*	6500*	9670	5650	6190	3790	4470	2780	3890	2430	8255
- 1.5m	10820*	10510	9550	5550	6100	3710	4430	2740	4230	2620	7767
- 3m	14570*	10690	9610	5600	6130	3740			5010	3100	6923
- 4.5m	11880*	11050	8450*	5800					6500*	4340	5562

LIFT CAPACITIES – DIPPER LENGTH: 2.4M, MONOBOOM: 5.7M, TRACKSHOES: 500MM, NO BUCKET **210X LC MONO**

Reach	3m		4.5m		6m		7.5m		Capacity at Max. Reach		mm
											
Load Point Height	kg	kg	kg	kg	kg	kg	kg	kg	kg	kg	mm
6m					5400*	5110			5400*	4160	6760
4.5m			6860*	6860*	5860*	4950			5310*	3460	7491
3m			8670*	7180	6650*	4720	5300	3370	4910	3120	7872
1.5m			10210*	6730	7270	4500	5190	3270	4750	3000	7954
0m			10870*	6520	7110	4350	5120	3210	4890	3070	7746
- 1.5m	10960*	10960*	10720*	6490	7060	4310			5400	3370	7223
- 3m	13500*	12880	9770*	6590	7150	4390			6630*	4120	6305
- 4.5m	10130*	10130*	7170*	6890					6590*	6350	4767

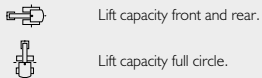

- Notes:**
- Lifting capacities are based on ISO 10567, that is: 75% of minimum tipping load or 87% of hydraulic lift capacity, whichever is the less. Lifting capacities marked* are based on hydraulic capacity.
 - Lift capacities assume that the machine is on firm, level ground.
 - Lift capacities may be limited by local regulations. Please refer to your dealer.

SPECIFICATION 210X LC/SC, 220X LC/SC/SLC

LIFT CAPACITIES – DIPPER LENGTH: 3.0M, MONOBOOM: 5.7M, TRACKSHOES: 500MM, NO BUCKET											210X LC MONO
Reach	3m		4.5m		6m		7.5m		Capacity at Max. Reach		
											
Load Point Height	kg	kg	kg	kg	kg	kg	kg	kg	kg	kg	mm
7.5m					4670*	4670*			3980*	3980*	6235
6m									3730*	3670	7339
4.5m					5300*	5020	5000*	3490	3690*	3110	8017
3m	12250*	12250*	7800*	7320	6140*	4760	5320	3380	3810*	2820	8374
1.5m			9550*	6780	7030*	4500	5170	3250	4080*	2710	8451
0m	6500*	6500*	10560*	6470	7060	4310	5070	3150	4410	2750	8255
- 1.5m	10820*	10820*	10750*	6360	6970	4220	5030	3120	4790	2980	7767
- 3m	14570*	12540	10170*	6420	7000	4250			5690	3520	6923
- 4.5m	11880*	11880*	8450*	6630					6500*	4920	5562

LIFT CAPACITIES – DIPPER LENGTH: 2.4M, MONOBOOM: 5.7M, TRACKSHOES: 500MM, NO BUCKET											220X SC MONO
Reach	3m		4.5m		6m		7.5m		Capacity at Max. Reach		
											
Load Point Height	kg	kg	kg	kg	kg	kg	kg	kg	kg	kg	mm
7.5m									5600*	5600*	5539
6m					5400*	5080			5400*	4160	6760
4.5m			6860*	6860*	5860*	4940			5280	3470	7491
3m			8670*	7080	6650*	4710	5180	3390	4810	3140	7872
1.5m			10210*	6640	7040	4490	5080	3290	4660	3020	7954
0m			10710	6440	6880	4350	5000	3220	4790	3090	7746
- 1.5m	10960*	10960*	10670	6410	6840	4310			5270	3390	7223
- 3m	13500*	12350	9770*	6510	6920	4380			6470	4120	6305
- 4.5m	10130*	10130*	7170*	6800					6590*	6280	4767

LIFT CAPACITIES – DIPPER LENGTH: 3.0M, MONOBOOM: 5.7M, TRACKSHOES: 500MM, NO BUCKET											220X SC MONO
Reach	3m		4.5m		6m		7.5m		Capacity at Max. Reach		
											
Load Point Height	kg	kg	kg	kg	kg	kg	kg	kg	kg	kg	mm
7.5m					4670*	4670*			3980*	3980*	6235
6m									3730*	3680	7339
4.5m					5300*	5000	5000*	3500	3690*	3120	8017
3m	12250*	12250*	7800*	7210	6140*	4740	5190	3390	3810*	2840	8374
1.5m			9550*	6690	7030*	4490	5060	3260	4080*	2730	8451
0m	6500*	6500*	10560*	6390	6840	4300	4950	3170	4320	2770	8255
- 1.5m	10820*	10820*	10550	6290	6750	4220	4910	3130	4690	2990	7767
- 3m	14570*	12030	10170*	6340	6780	4240			5550	3530	6923
- 4.5m	11880*	11880*	8450*	6540					6500*	4890	5562



Lift capacity front and rear.



Lift capacity full circle.











Notes:

1. Lifting capacities are based on ISO 10567, that is: 75% of minimum tipping load or 87% of hydraulic lift capacity, whichever is the less. Lifting capacities marked* are based on hydraulic capacity.
2. Lift capacities assume that the machine is on firm, level ground.
3. Lift capacities may be limited by local regulations. Please refer to your dealer.









LIFT CAPACITIES – DIPPER LENGTH: 2.4M, T.A.B.: 5.7M, TRACKSHOES: 500MM, NO BUCKET **220X SC T.A.B.**

Reach	3m		4.5m		6m		7.5m		Capacity at Max. Reach		mm
											
Load Point Height	kg	kg	kg	kg	kg	kg	kg	kg	kg	kg	mm
7.5m			7060*	7060*					5610*	5610*	5628
6m			7300*	7300*	6450*	5130			5110*	4100	6833
4.5m			8350*	7680	6810*	4960	5300	3470	4960*	3420	7557
3m			9760*	7060	7330	4700	5210	3380	4770	3090	7935
1.5m			10690*	6560	7050	4460	5090	3270	4620	2970	8016
0m	10420*	10420*	10660	6340	6880	4300	5010	3200	4740	3030	7809
- 1.5m			9770*	6310	6830	4260			5220	3330	7291
- 3m			7950*	6430	5810*	4350			5080*	4040	6383

LIFT CAPACITIES – DIPPER LENGTH: 3.0M, T.A.B.: 5.7M, TRACKSHOES: 500MM, NO BUCKET **220X SC T.A.B.**

Reach	3m		4.5m		6m		7.5m		Capacity at Max. Reach		mm
											
Load Point Height	kg	kg	kg	kg	kg	kg	kg	kg	kg	kg	mm
9m			4470*	4470*					4240*	4240*	4568
7.5m					4690*	4690*			3520*	3520*	6364
6m			6070*	6070*	5940*	5240			3260*	3260*	7449
4.5m	8760*	8760*	7640*	7640*	6380*	5060	5390	3540	3190*	3080	8118
3m			9130*	7260	7040*	4780	5250	3420	3250*	2800	8470
1.5m			10360*	6680	7110	4500	5110	3280	3440*	2700	8546
0m	6040*	6040*	10690	6360	6880	4300	4990	3170	3790*	2740	8353
- 1.5m	10320*	10320*	10210*	6250	6780	4210	4950	3140	4410*	2950	7871
- 3m	11650*	11650*	8810*	6310	6590*	4240			5040*	3470	7040

LIFT CAPACITIES – DIPPER LENGTH: 2.4M, MONOBOOM: 5.7M, TRACKSHOES: 500MM, NO BUCKET **220X LC MONO**

Reach	3m		4.5m		6m		7.5m		Capacity at Max. Reach		mm
											
Load Point Height	kg	kg	kg	kg	kg	kg	kg	kg	kg	kg	mm
7.5m									5600*	5600*	5539
6m					5400*	5400*			5400*	4620	6760
4.5m			6860*	6860*	5860*	5490			5310*	3870	7491
3m			8670*	7970	6650*	5260	5780*	3780	5390	3510	7872
1.5m			10210*	7510	7440*	5030	5700	3680	5230	3380	7954
0m			10870*	7300	7800	4890	5630	3610	5380	3460	7746
- 1.5m	10960*	10960*	10720*	7270	7750	4850			5940	3800	7223
- 3m	13500*	13500*	9770*	7370	7160*	4930			6630*	4360	6305
- 4.5m	10130*	10130*	7170*	7170*					6590*	6590*	4767

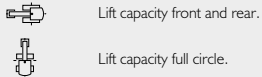

- Notes:**
- Lifting capacities are based on ISO 10567, that is: 75% of minimum tipping load or 87% of hydraulic lift capacity, whichever is the less. Lifting capacities marked* are based on hydraulic capacity.
 - Lift capacities assume that the machine is on firm, level ground.
 - Lift capacities may be limited by local regulations. Please refer to your dealer.

SPECIFICATION 210X LC/SC, 220X LC/SC/SLC

LIFT CAPACITIES – DIPPER LENGTH: 3.0M, MONOBOOM: 5.7M, TRACKSHOES: 500MM, NO BUCKET											220X LC MONO
Reach	3m		4.5m		6m		7.5m		Capacity at Max. Reach		
											
Load Point Height	kg	kg	kg	kg	kg	kg	kg	kg	kg	kg	mm
7.5m					4670*	4670*			3980*	3980*	6235
6m									3730*	3730*	7339
4.5m					5300*	5300*	5000*	3900	3690*	3480	8017
3m	12250*	12250*	7800*	7800*	6140*	5290	5370*	3780	3810*	3180	8374
1.5m			9550*	7560	7030*	5030	5690	3660	4080*	3060	8451
0m	6500*	6500*	10560*	7250	7690*	4840	5580	3560	4570*	3110	8255
- 1.5m	10820*	10820*	10750*	7150	7660	4760	5540	3520	5280	3370	7767
- 3m	14570*	14000	10170*	7200	7530*	4780			6240*	3970	6923
- 4.5m	11880*	11880*	8450*	7410					6500*	5510	5562

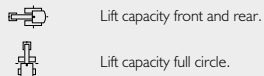

LIFT CAPACITIES – DIPPER LENGTH: 2.4M, T.A.B.: 5.7M, TRACKSHOES: 500MM, NO BUCKET											220X LC T.A.B.
Reach	3m		4.5m		6m		7.5m		Capacity at Max. Reach		
											
Load Point Height	kg	kg	kg	kg	kg	kg	kg	kg	kg	kg	mm
9m									7300*	7300*	3459
7.5m			7060*	7060*					5610*	5610*	5628
6m			7300*	7300*	6450*	5690			5110*	4560	6833
4.5m			8350*	8350*	6810*	5520	5460*	3870	4960*	3820	7557
3m			9760*	7960	7390*	5260	5850	3780	5040*	3460	7935
1.5m			10690*	7440	7860*	5010	5730	3670	5190	3330	8016
0m			10660*	7210	7810	4850	5650	3600	5340	3410	7809
- 1.5m	10420*	10420*	9770*	7180	7400*	4800			5580*	3740	7291
- 3m			7950*	7300	5810*				5080*	4540	6383

LIFT CAPACITIES – DIPPER LENGTH: 3.0M, T.A.B.: 5.7M, TRACKSHOES: 500MM, NO BUCKET											220X LC T.A.B.
Reach	3m		4.5m		6m		7.5m		Capacity at Max. Reach		
											
Load Point Height	kg	kg	kg	kg	kg	kg	kg	kg	kg	kg	mm
9m			4470*	4470*					4240*	4240*	4568
7.5m					4690*	4690*			3520*	3520*	6364
6m			6070*	6070*	5940*	5820			3260*	3260*	7449
4.5m	8760*	8760*	7640*	7640*	6380*	5620	5480*	3940	3190*	3190*	8118
3m			9130*	8170	7040*	5340	5900	3820	3250*	3140	8470
1.5m			10360*	7570	7640*	5060	5740	3680	3440*	3030	8546
0m	6040*	6040*	10730*	7230	7810	4850	5630	3570	3790*	3080	8353
- 1.5m	10320*	10320*	10210*	7120	7640*	4760	5580	3530	4410*	3320	7871
- 3m	11650*	11650*	8810*	7180	6590*	4790			5040*	3900	7040













- Notes:**
- Lifting capacities are based on ISO 10567, that is: 75% of minimum tipping load or 87% of hydraulic lift capacity, whichever is the less. Lifting capacities marked* are based on hydraulic capacity.
 - Lift capacities assume that the machine is on firm, level ground.
 - Lift capacities may be limited by local regulations. Please refer to your dealer.

LIFT CAPACITIES – DIPPER LENGTH: 2.4M, MONOBOOM: 5.7M, TRACKSHOES: 500MM, NO BUCKET **220X SLC MONO**

Reach	3m		4.5m		6m		7.5m		Capacity at Max. Reach		mm
											
Load Point Height	kg	kg	kg	kg	kg	kg	kg	kg	kg	kg	mm
7.5m									5600*	5600*	5539
6m					5400*	5120			5400*	4190	6760
4.5m			6860*	6860*	5860*	4970			5310*	3500	7491
3m			8670*	7130	6650*	4740	5770	3410	5350	3160	7872
1.5m			10210*	6690	7440*	4520	5660	3320	5190	3050	7954
0m			10870*	6490	7740	4380	5590	3250	5340	3110	7746
- 1.5m	10960*	10960*	10720*	6460	7690	4340			5890	3410	7223
- 3m	13500*	12440	9770*	6560	7160*	4420			6630*	4160	6305
- 4.5m	10130*	10130*	7170*	6850					6590*	6330	4767

LIFT CAPACITIES – DIPPER LENGTH: 3.0M, MONOBOOM: 5.7M, TRACKSHOES: 500MM, NO BUCKET **220X SLC MONO**

Reach	3m		4.5m		6m		7.5m		Capacity at Max. Reach		mm
											
Load Point Height	kg	kg	kg	kg	kg	kg	kg	kg	kg	kg	mm
7.5m					4670*	4670*			3980*	3980*	6235
6m									3730*	3710	7339
4.5m					5300*	5030	5000*	3530	3690*	3150	8017
3m	12250*	12250*	7800*	7260	6140*	4770	5370*	3420	3810*	2860	8374
1.5m			9550*	6740	7030*	4520	5640	3290	4080*	2750	8451
0m	6500*	6500*	10560*	6430	7690*	4340	5540	3190	4570*	2800	8255
- 1.5m	10820*	10820*	10750*	6340	7610	4250	5500	3160	5240	3020	7767
- 3m	14570*	12120	10170*	6390	7530*	4280			6210	3560	6923
- 4.5m	11880*	11880*	8450*	6590					6500*	4930	5562

LIFT CAPACITIES – DIPPER LENGTH: 2.4M, MONOBOOM: 5.7M, TRACKSHOES: 600MM, NO BUCKET **220X LC DOZER MONO**

Reach	3m		4.5m		6m		7.5m		Capacity at Max. Reach		mm
											
Load Point Height	kg	kg	kg	kg	kg	kg	kg	kg	kg	kg	mm
7.5m									5600*	5600*	5539
6m					5400*	5400*			5400*	4940	6760
4.5m			6860*	6860*	5860*	5860			5310*	4150	7491
3m			8670*	8510	6650*	5630	5780*	4060	5450*	3770	7872
1.5m			10210*	8060	7440*	5410	6120*	3960	5840*	3640	7954
0m			10870*	7850	7940*	5260	6330*	3900	6080	3730	7746
- 1.5m	10960*	10960*	10720*	7820	7960*	5220			6390*	4090	7223
- 3m	13500*	13500*	9770*	7920	7160*	5300			6630*	4980	6305
- 4.5m	10130*	10130*	7170*	7170*					6590*	6590*	4767

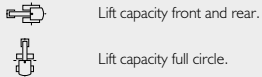

- Notes:**
- Lifting capacities are based on ISO 10567, that is: 75% of minimum tipping load or 87% of hydraulic lift capacity, whichever is the less. Lifting capacities marked* are based on hydraulic capacity.
 - Lift capacities assume that the machine is on firm, level ground.
 - Lift capacities may be limited by local regulations. Please refer to your dealer.

SPECIFICATION 210X LC/SC, 220X LC/SC/SLC

LIFT CAPACITIES – DIPPER LENGTH: 3.0M, MONOBOOM: 5.7M, TRACKSHOES: 600MM, NO BUCKET											220X LC DOZER MONO
Reach	3m		4.5m		6m		7.5m		Capacity at Max. Reach		
											
Load Point Height	kg	kg	kg	kg	kg	kg	kg	kg	kg	kg	mm
7.5m					4670*	4670*			3980*	3980*	6235
6m									3730*	3730*	7339
4.5m					5300*	5300*	5000*	4180	3690*	3690*	8017
3m	12250*	12250*	7800*	7800*	6140*	5660	5370*	4070	3810*	3430	8374
1.5m			9550*	8110	7030*	5400	5820*	3940	4080*	3310	8451
0m	6500*	6500*	10560*	7790	7690*	5220	6160*	3840	4570*	3370	8255
- 1.5m	10820*	10820*	10750*	7690	7920*	5130	6190*	3800	5450*	3640	7767
- 3m	14570*	14570*	10170*	7740	7530*	5160			6240*	4280	6923
- 4.5m	11880*	11880*	8450*	7950					6500*	5920	5562





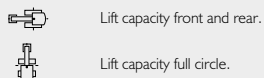















LIFT CAPACITIES – DIPPER LENGTH: 2.4M, T.A.B.: 5.7M, TRACKSHOES: 600MM, NO BUCKET											220X LC DOZER T.A.B.
Reach	3m		4.5m		6m		7.5m		Capacity at Max. Reach		
											
Load Point Height	kg	kg	kg	kg	kg	kg	kg	kg	kg	kg	mm
9m									7300*	7300*	3459
7.5m				7060*	7060*				5610*	5610*	5628
6m				7300*	7300*	6450*	6070		5110*	4880	6833
4.5m				8350*	8350*	6810*	5900	5460*	4150	4960*	7557
3m				9760*	8500	7390*	5630	6170*	4060	5040*	7935
1.5m				10690*	7990	7860*	5380	6290*	3950	5330*	8016
0m				10660*	7760	7930*	5220	6140*	3880	5770*	7809
- 1.5m	10420*	10420*		9770*	7730	7400*	5180		5580*	4030	7291
- 3m				7950*	7850	5810*	5270		5080*	4880	6383

LIFT CAPACITIES – DIPPER LENGTH: 3.0M, T.A.B.: 5.7M, TRACKSHOES: 600MM, NO BUCKET											220X LC DOZER T.A.B.
Reach	3m		4.5m		6m		7.5m		Capacity at Max. Reach		
											
Load Point Height	kg	kg	kg	kg	kg	kg	kg	kg	kg	kg	mm
9m										4240*	4568
7.5m				4470*	4470*				3520*	3520*	6364
6m				6070*	6070*	5940*	5940*		3260*	3260*	7449
4.5m	8760*	8760*		7640*	7640*	6380*	6000	5480*	4220	3190*	8118
3m				9130*	8710	7040*	5710	5920*	4100	3250*	8470
1.5m				10360*	8110	7640*	5430	6170*	3960	3440*	8546
0m	6040*	6040*		10730*	7780	7900*	5220	6210*	3850	3790*	8353
- 1.5m	10320*	10320*		10210*	7670	7640*	5130	5800*	3810	4410*	7871
- 3m	11650*	11650*		8810*	7730	6590*	5160		5040*	4210	7040



- Notes:**
- Lifting capacities are based on ISO 10567, that is: 75% of minimum tipping load or 87% of hydraulic lift capacity, whichever is the less. Lifting capacities marked* are based on hydraulic capacity.
 - Lift capacities assume that the machine is on firm, level ground.
 - Lift capacities may be limited by local regulations. Please refer to your dealer.

LIFT CAPACITIES – DIPPER LENGTH: 6.4M, MONOBOOM: 8.7M, TRACKSHOES: 500MM, NO BUCKET **220X LC LR MONO**

Reach	3m		4.5m		6m		7.5m		9m		10.5m		12m		13.5m		Capacity at Max. Reach					
																					mm	
Load Point Height	kg	kg	kg	kg	kg	kg	kg	kg	kg	kg	kg	kg	kg	kg	kg	kg	kg	kg	kg	kg	mm	
11.5m																			1370*	1370*	10801	
10.5m																			1310*	1310*	11627	
9m														2020*	1890				1250*	1250*	12615	
7.5m														2090*	1870				1230*	1230*	13363	
6m														2220*	2220*	2170*	1820	1860*	1380	1220*	1220*	13909
4.5m									2580*	2580*	2410*	2250	2290*	1730	2220*	1340			1240*	1160	14276	
3m	8960*	8960*			4090*	4090*	3370*	3370*	2930*	2720	2640*	2090	2450*	1630	2180	1280			1270*	1080	14478	
1.5m	3210*	3210*	7070*	6520	4970*	4450	3910*	3260	3280*	2490	2880*	1940	2580	1530	2110	1210			1320*	1030	14523	
0m	3290*	3290*	7600*	5730	5710*	3960	4400*	2940	3620*	2280	3040	1800	2480	1440	2050	1150			1410*	1010	14410	
- 1.5m	4200*	4200*	7280*	5350	6210*	3640	4700	2710	3640	2110	2920	1680	2390	1360	2000	1110			1520*	1020	14138	
- 3m	5350*	5350*	8020*	5210	6280	3470	4540	2570	3520	2000	2830	1600	2340	1310	1980	1090			1680*	1070	13695	
- 4.5m	6660*	6660*	8860*	5220	6220	3420	4470	2500	3460	1940	2790	1560	2320	1290					1910*	1150	13066	
- 6m	8180*	8180*	8520*	5320	6250	3450	4480	2510	3460	1940	2800	1570	2350	1320					2260*	1290	12220	
- 7.5m	9960*	9960*	7900*	5510	6040*	3550	4550	2580	3520	2000	2870	1640							2680	1540	11107	
- 9m	9560*	9560*	6900*	5800	5350*	3750	4260*	2720	3390*	2140									3020*	1980	9636	
- 10.5m			5280*	5280*	4110*	4060	3110*	3010											3040*	2960	7598	



Lift capacity front and rear.



Lift capacity full circle.

- Notes:**
1. Lifting capacities are based on ISO 10567, that is: 75% of minimum tipping load or 87% of hydraulic lift capacity, whichever is the less. Lifting capacities marked* are based on hydraulic capacity.
 2. Lift capacities assume that the machine is on firm, level ground.
 3. Lift capacities may be limited by local regulations. Please refer to your dealer.

Your nearest JCB dealer

JCB Sales Limited, Rocester, Staffordshire, United Kingdom ST14 5JP
Tel: +44 (0)1889 590312 Email: salesinfo@jcb.com
Download the very latest information on this product range at: www.jcb.com

29206 en-GB 04/21 Issue 3

©2021 JCB Sales. All rights reserved. No part of this publication may be reproduced, stored in a retrieval system, or transmitted in any form or by any other means, electronic, mechanical, photocopying or otherwise, without prior permission from JCB Sales. All references in this publication to operating weights, sizes, capacities and other performance measurements are provided for guidance only and may vary dependant upon the exact specification of machine. They should not therefore be relied upon in relation to suitability for a particular application. Guidance and advice should always be sought from your JCB Dealer. JCB reserves the right to change specifications without notice. Illustrations and specifications shown may include optional equipment and accessories. The JCB logo is a registered trademark of J C Bamford Excavators Ltd.

